

z: *zanotta:* is now

2020/2021



zanottaspa@zanotta.it
www.zanotta.it

Zanotta USA
US - New York, NY, 10001
1201 Broadway, Ste. 907-909

Showroom Zanotta
I-20154 Milano
Caselli di Porta Garibaldi
Piazza XXV Aprile 16
Tel +39 0362 498400

Zanotta Spa
I - 20834 Nova Milanese
Via Vittorio Veneto 57
+39 0362 4981

2020/2021

zanotta:

A:

Albero | **416** | 392 | 514
Alfa | **86** | 185 | 442
Allunaggio | **406** | 514
April | **260** | 331, 390, 395 | 482
Arabesco CM | **186** | 472
Ardea CM | **140** | 226 | 462
Arom | **156** | 462
Aster | **420** | 100, 103, 211 | 514

B:

Basello | **194** | 472
Blanco | **306** | 494
Botero | **90** | 443
Box | **376** | 504
Bruce | **64** | 443
Butterfly | **184** | 473

C:

Calamo | **328** | 353 | 494
Calla | **159** | 463
Carlino CM | **202** | 25 | 473
Cavour CM | **318** | 390, 392 | 495
Celestina | **274** | 352, 353 | 482
Chichibio | **433** | 515
Club | **92** | 445
Comacina | **330** | 496
Cumano | **180** | 74, 89, 111, 128, 145 | 473

D:

Dan | **238** | 17, 19, 111 | 482
Dan | **242** | 225 | 483
Derby | **160** | 463
Dove | **38** | 10, 12, 22 | 445

E:

Echino | **178** | 386 | 474
Elica | **302** | 225 | 496
Elipse | **266** | 483

F:

Fenice | **310** | 497
Fenis CM | **276** | 70 | 483
Flamingo | **76** | 446
Florin | **379** | 504
Follia | **408** | 213, 217 | 515

G:

Genni | **136** | 464
Gilda CM | **132** | 29, 31 | 464
Giotto | **432** | 515
Girò | **190** | 474
Grangala | **372** | 505
Graphium | **166** | 109 | 474
Greg | **374** | 506
Greta | **378** | 506

H:

Hiro | **68** | 447

I:

Ido | **282** | 329 | 484

J:

Joy | **412** | 97, 101 | 516
Judy | **138** | 349 | 465
June | **262** | 484

K:

Kent | **162** | 465
Kilt | **88** | 448
Kim | **80** | 450

L:

Lama | **146** | 223 | 466
Lea | **254** | 485
Lealta | **258** | 485
Leo | **281** | 486
Leonardo | **322** | 497
Lia | **252** | 309 | 486
Lialta | **258** | 487
Lio | **281** | 486
Liza | **272** | 487
Lord | **280** | 488
Loto | **192** | 475
Louise | **150** | 466

M:

Maggiolina | **126** | 24, 364 | 467
Marcuso | **312** | 498
Mezzadro | **402** | 67, 210, 324 | 516
Milano | **370** | 507
Milano+ | **58** | 218 | 451
Milleunanotte | **375** | 507
Milo CM | **434** | 516
Moretta | **144** | 344, 346, 351 | 467
Museo | **418** | 517

N:

Nena | **244** | 228, 230, 233, 390 | 489
Ninfea | **192** | 95 | 475
Niobe | **170** | 11, 12, 70, 82, 231 | 475
Noli | **278** | 489
Nyx | **366** | 508

O:

Oliva | **152** | 112 | 467
Onda | **62** | 452
Orione | **308** | 498
Oscar | **204** | 377 | 475

P:

Pablo | **436** | 517
Parco | **94** | 452
Pianoalto | **48** | 106, 109 | 453
Poker | **314** | 499
Primate | **410** | 517

Q:

Quaderna consolle | **300** | 336, 341 | 499
Quaderna scrivania | **298** | 499
Quaderna tavolino | **176** | 107, 300, 383 | 476
Quaderna tavolo | **296** | 17, 352 | 499

R:

Raperonzolo | **437** | 518
Reale | **290** | 500
Reale CM | **286** | 209, 210 | 500
Ricordi | **358** | 344, 346 | 508
Rider | **118** | 101 | 468

S:

Sacco Small | **122** | 468
Sacco Medium | **122** | 468
Sacco | **122** | 9, 27, 34, 105, 211, 214, 216, 221, 234, 342, 354, 384, 389 | 468
Sant'Elia | **142** | 334 | 469
Santiago | **316** | 264 | 501
Sciangai | **398** | 30 | 518
Scott | **72** | 454
Sella | **404** | 32, 79, 83 | 518
Servento | **430** | 519
Servietto | **424** | 519
Servobandiera | **428** | 520
Servofumo | **427** | 520
Servomanto | **422** | 521
Servomuto | **174** | 70, 83, 89, 100, 157 | 476
Servonotte | **425** | 371 | 519
Servopluvio | **426** | 520
Servostop | **431** | 521
Sgabillo | **196** | 337 | 476
Shiki | **54** | 28 | 456
Spotty | **188** | 477
Susanna | **154** | 82 | 469

T:

Talamo | **362** | 337, 339 | 509
Talia | **256** | 490
Taschino | **206** | 346, 348 | 477
Tempo | **198** | 71, 74 | 477
Teti | **201** | 22 | 478
Throw Away | **84** | 457
Tod | **199** | 371 | 478
Toi | **191** | 478
Tonietta | **248** | 112, 209, 210, 216 | 490
Tucano | **326** | 112 | 502
Tusa | **270** | 491
Tweed | **292** | 228, 230 | 502

V:

Veryround | **438** | 521

W:

William | **42** | 382 | 457

Z:

Zeus | **200** | 22 | 479

P: Premi ricevuti
Awards received
Prix reçus
Preise gewonnen
Premios recibidos

C: Collezioni in cui è inserito il prodotto
Collections where the product is included
Collections dans lesquelles le produit est inclu
Sammlungen worin das Produkt sich befindet
Colecciones en las que el producto es incluido

zanotta: *is now*

Siamo il luogo dove da sempre si sogna,
si pensa e si progetta il futuro. Siamo il luogo dove
l'azzardo non è un rischio, dove il bello non è mai singolare.
Siamo il luogo dove l'azione è relazione,
dialogo e connessione tra spazi, persone e oggetti.
Siamo il luogo dove la messa in scena del quotidiano
è un processo in continua evoluzione.
Siamo il luogo dove l'essenza del progetto genera
emozioni autentiche. Perchè ogni oggetto ha un racconto,
ogni uomo ha un vissuto, ogni luogo ha una storia.
Da progettare. Da raccontare. Da vivere.

*We are the place where we dream, envision and design
the future. We are the place where risk is unassailable,
where beauty is always shared. We are the place where
relationships, dialogue and connections happen between spaces,
people and objects. We are the place where the staging of everyday
life unfolds in continuous evolution. We are the place where the
essence of design generates authentic emotions. Because each
object has a story, each person has a life experience, each place
has a history. To design. To tell. To live.*

: *that's life*

Da sempre crediamo che le case che abitiamo raccontino la nostra vita,
la nostra storia, le nostre passioni. Contenitori unici, risultato della stratificazione
generata dallo scorrere del tempo e dalle nostre esperienze. Case in cui
i nostri oggetti trovano il loro spazio ideale. Ogni volta in modo diverso,
talvolta inaspettato, perchè interpretato da persone diverse.

*We've always believed that the houses we live
in tell our life story, our history, our passions.
They are unique containers, the result of the stratification
generated by the passage of time and our experiences.
Homes in which our objects find their ideal setting.
Each time in a different way, sometimes unexpectedly,
because they are interpreted by different people.*

: *WOW*

Ci piace stupire.
E ci piace farlo con i nostri oggetti, capaci
di fondersi con spontaneità e naturalezza
in contesti vivi e vissuti, senza regole fisse
o preconcetti. Ci piace stupire per emozionare.
Per emozionarci.

*We love to astonish.
And we love doing so with our objects,
capable of blending in, spontaneously
and naturally, in lively and lived in spaces,
with no set rules or preconceptions.
We love to astonish and move others.
And we love to be moved, in return.*

: *more is better*

139 designer, 310 prodotti, 53 i musei
nei quali sono esposti, 55 i prodotti premiati.
Ma alla base abbiamo un'unica visione,
sempre la stessa, da oltre 60 anni: la voglia
di sorprendere per costruire un rapporto,
mai scontato, tra oggetti e persone.

*139 designers, 310 products, 53 museums
where they are on exhibition, 55 award-winning
products. Fundamentally, however, we share a single
vision, the same as always, for more than 60 years:
the desire to surprise so as to establish a relationship,
one which is never banal, between objects and people.*

“L’aspetto culturale è stato il cuore vitale della nostra storia e ancora in prospettiva può essere la carta vincente se accortamente giocata”.

“The vital question of culture has always been at the heart of our history and can be the winning card for our future prospects, if played carefully”.

Aurelio Zanotta, Aspen, 1989

: it's your turn

Sfoggia, sogna, trai ispirazione, sorridi, rilassati.

Turn the pages, dream, get inspired, smile, relax.

Abbiamo deciso di raccontare il vivere contemporaneo attraverso un viaggio poliedrico all’interno di dodici case. Dodici racconti i cui protagonisti sono persone reali, ciascuna con la propria storia, con la propria vita, con le proprie passioni. Dodici persone ritratte all’interno delle loro abitazioni. Frammenti di scene di vita quotidiana che si alternano ai nostri prodotti, da sempre parte integrante dell’abitare. Densità e rarefazione, velocità e lentezza.

Proprio come il ritmo delle nostre vite.

We've decided to tell the tale of contemporary living through a polyhedral journey through twelve homes. Twelve stories in which the protagonists are real people, each with a personal story, an individual life, singular passions. Twelve people portrayed inside of their homes. Fragments of scenes from everyday life which intermingle with our products, forever an integral part of living. Dense and rarified, rapid and leisurely. Just like the rhythm of our lives.

: PLAY

Marialaura Rossiello Irvine



STATION.



12 **Niobe** | tavolini, piano marmo bianco di Carrara, struttura bianca / small tables, white Carrara marble top, white frame
Dove | divano, tessuto Quid 40326, piedini verniciati grafite / sofa, fabric Quid 40326, graphite painted feet



**: così amo vivere
e lavorare: un unico spazio
in cui oggetti, collezioni
e materiali raccontano
la nostra vita e la mia
ricerca progettuale.**

*: this is how I love to live
and work: a single space
in which objects, collections
and materials manifest our life
and my design quest.*



Quaderna | tavolo / table

Dan | sedia, struttura grigio ferro, cinghie gialle / chair, iron grey frame, yellow straps

Dan | sedia, struttura nera, cinghie corda / chair, black frame, string straps

Dan | sedia, struttura nera, cinghie gialle / chair, black frame, yellow straps

: ogni componente della famiglia ha il suo spazio per poter esprimere la propria libertà e le proprie passioni. Ma attenzione: sono gli oggetti che mi appartengono, e non io ad appartenere a loro.

: every member of the family has space in which to express their individual freedom and passions. But take note: It is the objects that belong to me, not I who belong to them.





: UN ANGOLO DI PACE TUTTO MIO.

: my own peaceful haven.

Elizabeth Le Van Kim





Maggiolina | poltrona, pelle Super 0917, scocca cuoio 0807, struttura nichel satinata nera /
armchair, leather Super 0917, sling in cowhide 0807, black nickel-satin finished frame



Carlino CM | contenitore bianco / white storage unit



**: le origini vietnamite,
i numerosi viaggi in Asia,
gli anni trascorsi
in Francia, l'Italia.
Un diario di viaggio.
La mia casa.**

*: my Vietnamese origins, numerous trips to Asia,
years spent in France and Italy. A travel diary.
My home.*





**: AMIAMO GLI SPAZI APERTI,
DOVE TUTTO È A VISTA,
NIENTE DA NASCONDERE.**

Melissa Arroni e Emanuele Nardoni

*: we love open spaces, where everything
is in sight, nothing to be hidden.*

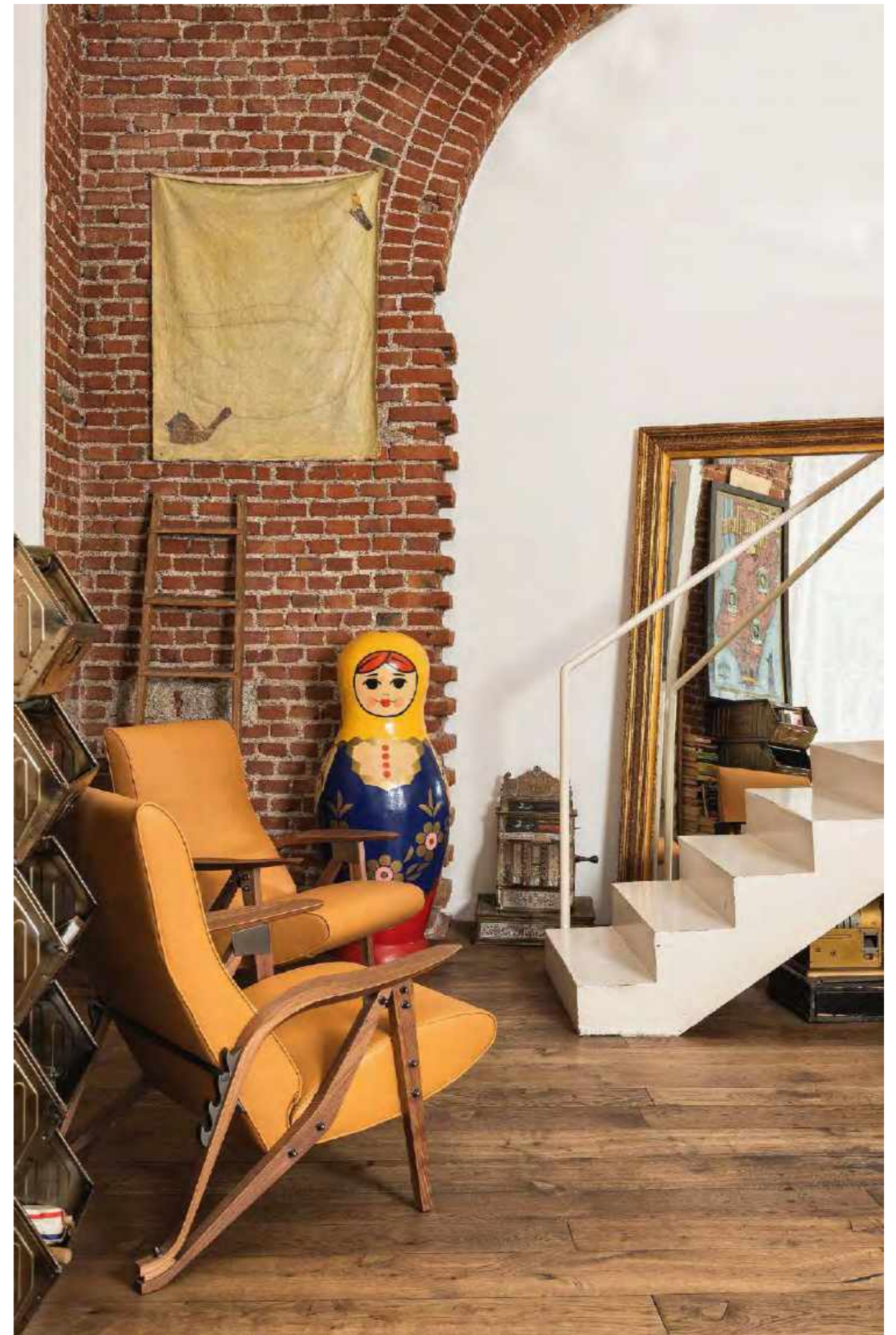





**: per noi la vita va vissuta come un viaggio
in cui non è importante l'arrivo,
ma tutto quello che si vive durante.
Un viaggio per il quale partiamo leggeri
e torniamo carichi. Carichi di energia,
ma anche carichi di tanti oggetti
e ricordi.**

*: for us, life should be lived like a journey, where
the important thing isn't the destination, but the what
you experience in the meantime. A trip for which
we pack light and return loaded. Loaded with energy,
but also many objects and memories.*

**Perché produrre un nuovo divano?
Perché per noi significa dialogare con le persone
entrando in rapporto con la quotidianità di ciascuno.
Non un semplice prodotto, ma un luogo dove essere
se stessi, da soli o con altre persone, al telefono
o in un momento di quiete, a casa o in uno spazio
pubblico. Il comfort delle imbottiture, la qualità
dei rivestimenti e la praticità nello sfoderarli,
la solidità delle strutture, la cura di ogni dettaglio,
infatti, rendono i nostri divani perfetti per qualsiasi
ambiente. Divani che segnano il proprio tempo.
Ma, nel tempo, vivono.**

*Why produce a new sofa? Because, for us,
it is a chance to interact with people and become
a part of their daily lives. A sofa is not just a product,
it is a place where we can be ourselves, individually
or with others, on the telephone or during a quiet moment,
at home or in a public space. The comfort of the cushions,
the quality of the upholstery, the ease with which they
can be uncovered, the sturdiness of the frames,
the attention to details, in fact, make our sofas
perfect for every setting. Sofas that mark an era.
But, over time, take on a life of their own.*



Dove | 38 | 10, 12, 22



William | 42 | 382



Pianoalto | 48 | 106, 109



Shiki | 54 | 28



Milano+ | 58 | 218



Onda | 62



Bruce | 64



Hiro | 68



Scott | 72



Flamingo | 76



Kim | 80



Throw Away | 84



Alfa | 86 | 185



Kilt | 88



Botero | 90



Club | 92



Parco | 94

Dove

Design
Ludovica+Roberto Palomba
2020

Un divano come un morbido *cuscinò*

A sofa as soft as a pillow





Il divano è fatto di poche ed essenziali componenti, ma ben calibrate: due piedini e una barra che sostiene la parte morbida costituita da tre soffici cuscini: uno per la seduta, uno per lo schienale ed uno per il bracciolo. Ciò che ne emerge è un'idea forte di cocooning, di accoglienza, di abbraccio. "Il cuscino sintetizza la nostra idea di semplice accoglienza della quotidianità, perché è un compagno di relax, di coccole, un rifugio, l'oggetto d'uso quotidiano per antonomasia."

This sofa is made of only a few essential components, but each is well calibrated: two legs and a bar to support the softer part, composed of three comfortable cushions: one for the seat, one for the backrest and one for the armrest. What immediately emerges is the concept of cocooning, a welcoming embrace. "The cushion epitomizes our idea of the simple hospitality of everyday life, since it represents our companion for relaxation and cuddling, a refuge, the quintessential object for daily use."

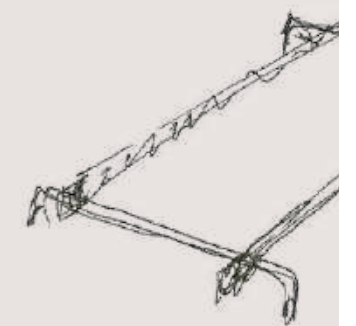
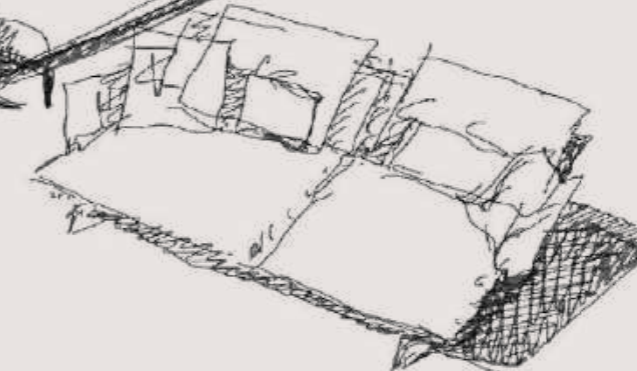
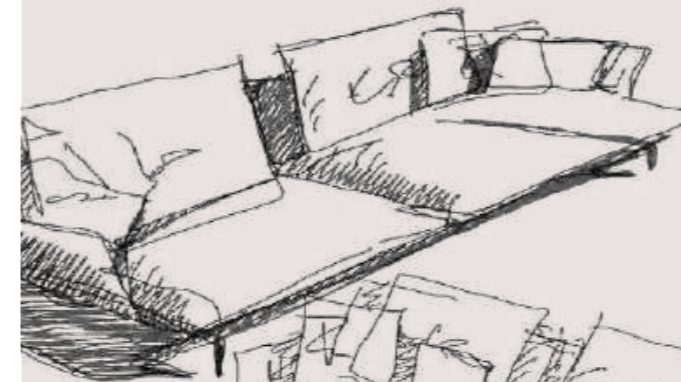
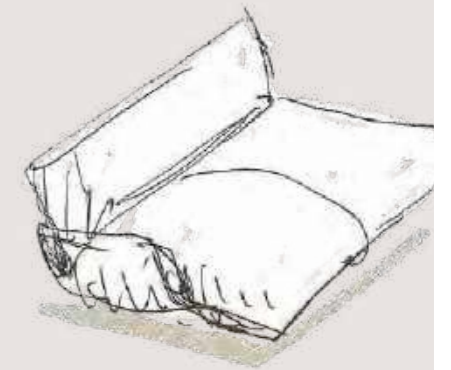
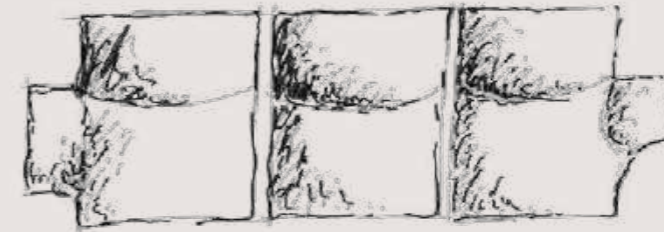

William

Design
Damian Williamson
2010-2015



Leggero e *tre* volte comodo

Light with triple the comfort





Due posti / *Two seater*



Due posti large / *Two seater large*



Tre posti / *Three seater*

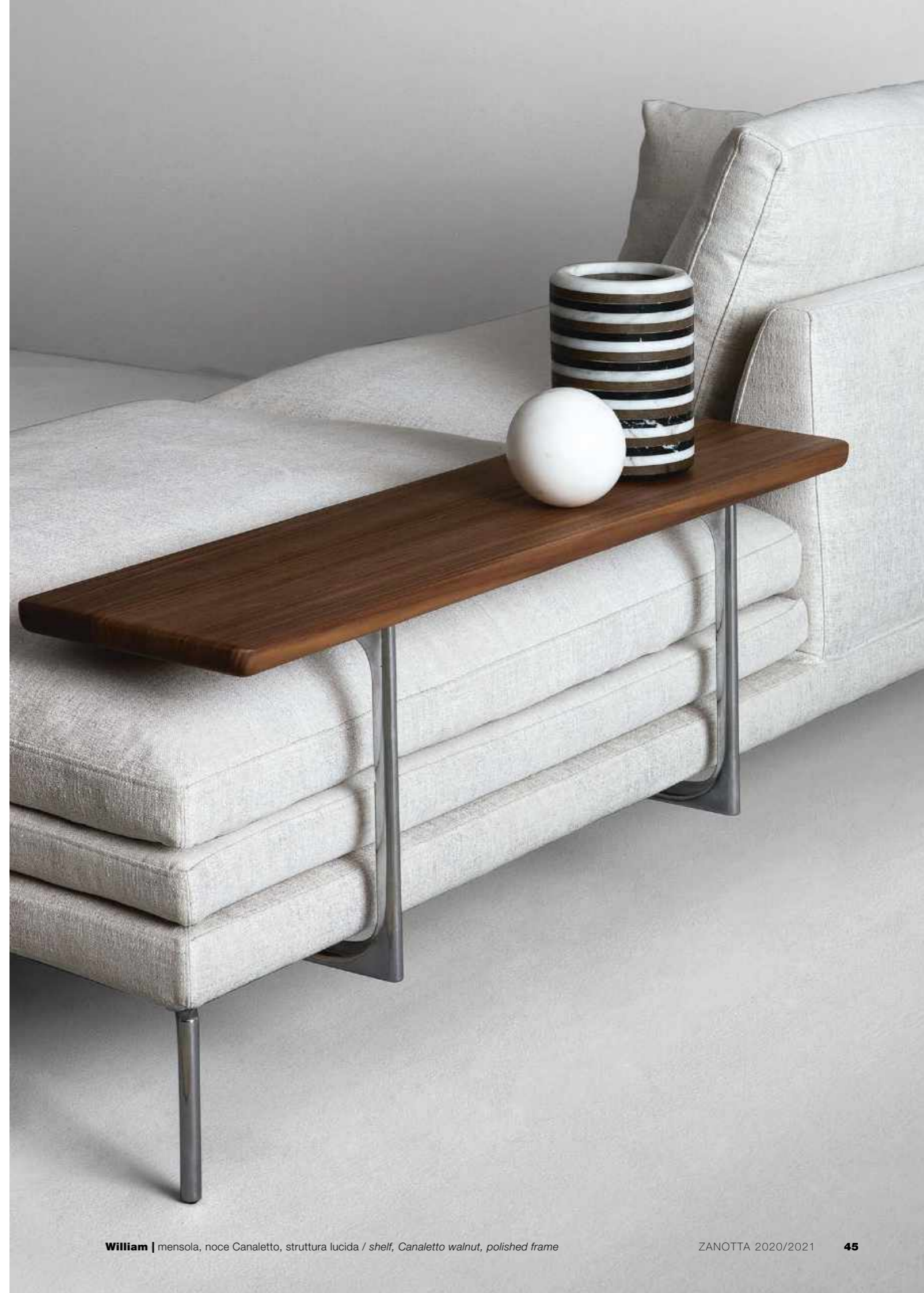



Con le sue linee asciutte ed eleganti sostenute dall'idea minima ed efficace di suddividere in tre sottili strati – anziché i classici due – il volume della seduta, assicura leggerezza visiva e un grande comfort. Distilla i principi della tradizione democratica del design scandinavo basati sul sacro trionomio di essenzialità/funzionalità/qualità, di cui Damian Williamson – designer londinese classe 1974 con base a Stoccolma – si fa felice e calibrato portavoce. E questo suo sistema di sedute imbottite, è già realmente diventato un nuovo classico.

With its clean, elegant lines, supported by the minimal idea of dividing the volume of the seat into three slender layers – instead of the traditional two – William ensures visual lightness and superior comfort. A distillate of the democratic principles of Scandinavian design, based on the sacred trio of essentiality/functionality/quality, of which Damian Williamson – the Stockholm-based designer born in London in 1974 – is pleased to be an esteemed spokesperson. His padded seating system has already become an authentic new classic.

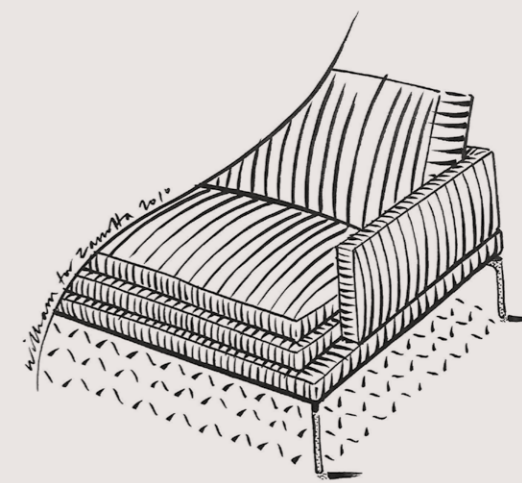
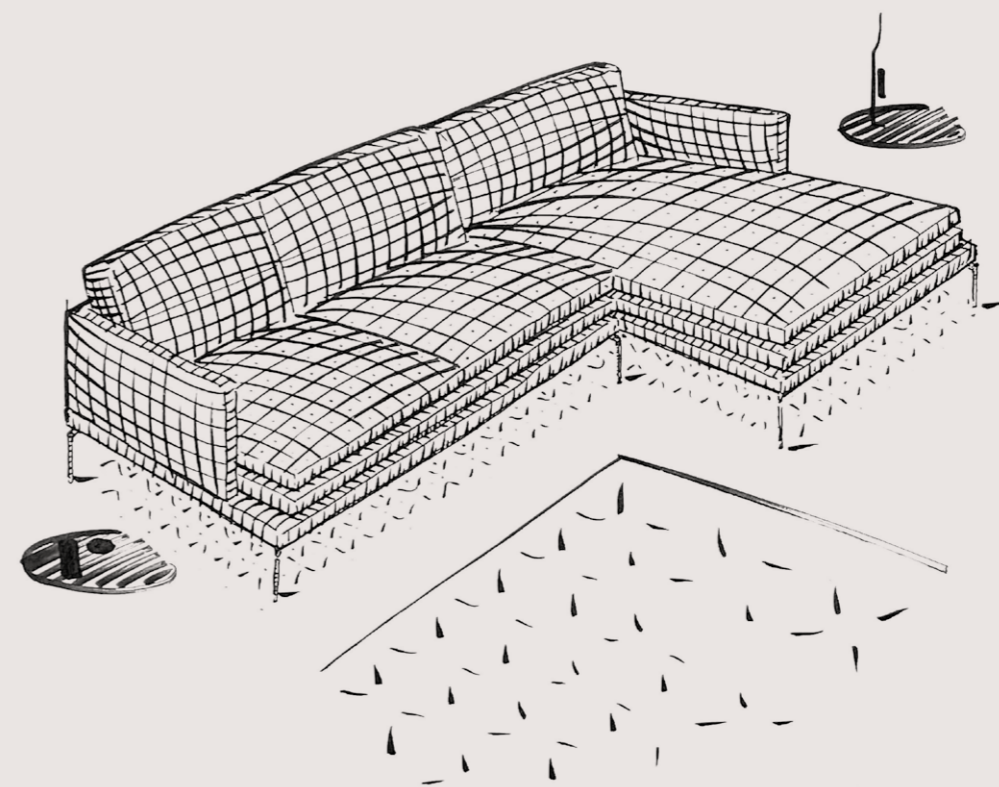

Pianoalto
Pianoalto 96

Design
Ludovica+Roberto Palomba
2012



Isle di relax

Isles of leisure







Shiki

Design
Damian Williamson
2019

Un'elegante impuntura
dai dettagli *sartoriali*

Elegant stitchwork
with sartorial details







Proporzioni + rigore,
leggerezza + morbidezza

*Proportions + form,
lightness + softness*





Onda

Design
De Pas, D'Urbino, Lomazzi
1985



Curve che avvolgono il corpo, come un
abbraccio

*Curves that envelop the body,
like an embrace*



Nel panorama degli anni Ottanta, fortemente caratterizzato dalle teorie del movimento post-moderno e dall'uso indiscriminato del decoro, Onda si pone come esempio di ricerca e sperimentazione di nuovi sistemi costruttivi capaci di innovare. La struttura esterna del divano ne è infatti un esempio: un'inedita tecnica di assemblaggio dei tubi senza ricorrere all'uso della saldatura. I tubi che compongono la struttura sono collegati tra di loro facendoli prima scorrere gli uni dentro gli altri e poi bloccati con dei tiranti a vite inseriti lungo i montanti verticali.

Within the 1980's panorama, which was strongly characterized by the influences of the post-modern movement and by the indiscriminate use of decorative elements, Onda provides an example of research and experimenting new construction systems with the potential to innovate. In fact, the sofa's external structure is such an example: a novel assembly technique for the tubes that does not require welding. The tubes used to compose the structure are first interconnected by inserting one into the other and then attaching them with braces screwed in along the vertical shafts.



Bruce

Design
Ludovica+Roberto Palomba
2013



Soffici impunture

ammorbidiscono il rigore

Plush stitches to soften the form



Bruce | tessuto Vico 27853, piedini lucidi / fabric Vico 27853, polished feet
tessuto Quinoa 32205, piedini nichelsatinati nero / fabric Quinoa 32205, black nickel-satin finished feet



Bruce | pelle Extra 0414, piedini lucidi / leather Extra 0414, polished feet **Mezzadro** | sgabello / stool

Hiro

Design
Damian Williamson
2018



Si libra compatto e *disinvolto*

Floats above the floor, compact and casual





Hiro | pelle Super 0913, piedini nichel-satinati nero / leather Super 0913, black nickel-satin finished feet
Fenis | sedia / chair **Servomuto** | **Niobe** | **Tempo** tavolini / small tables

Scott

Design
Ludovica+Roberto Palomba
2014



Una piccola *casa* nella *casa*

A little home within a home





Flamingo

Design
Damian Williamson
2017



Proporzioni,
equilibrio
volumi sospesi

*Proportions,
balance,
suspended volumes*





Due posti / Two seater



Tre posti / Three seater

Flamingo | pelle Extra 0438, piedini neri / leather Extra 0438, black feet
tessuto Vins 27756, piedini neri / fabric Vins 27756, black feet



Flamingo | pelle Extra 0442, piedini lucidi / leather Extra 0442, polished feet
Sella | sedile / seat

Kim

Design
Ludovica+Roberto Palomba
2018

Curve *armoniche*
e morbidezze *seducenti*



Harmonious curves, seductive softness





Kim | tessuto Tito 31829, piedini nichelsatinati naturale / fabric Tito 31829, natural nickel-satin-finished feet **Susanna** | poltrona / armchair
Niobe | **Servomuto** | tavolini / small tables **Sella** | sedile / seat

Throw Away

Design
Willie Landels
1965

P: Medaglia d'Oro Mostra Internazionale M.I.A. 1970; Interior Innovation Award Köln 2003.

C: Museum für Angewandte Kunst, Köln; Thessaloniki Design Museum, Saloniki; Die Neue Sammlung, München.

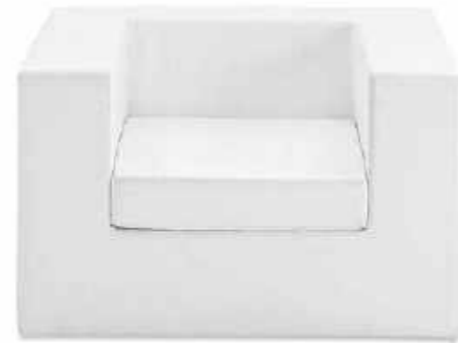

Senza spigoli,
senza struttura.

Morbidezza
compatta

*So long to stiffness and structure.
Compact softness*

Un divano che ha segnato un'epoca. Throw Away ha rappresentato una grande innovazione nel settore del mobile: fu il primo esempio al mondo di un divano con struttura realizzata al 100% in poliuretano da blocco, senza l'ausilio di telai portanti in legno, metallo o altri materiali. Incollando tra loro dei semplici blocchi di poliuretano espanso, infatti, Willie Landels, pittore e grafico scozzese naturalizzato italiano, aveva realizzato per proprio conto un divano senza spigoli contudenti e pericolosi per i bambini.

A sofa that marked an era. Throw Away represents a great moment of innovation in the furniture industry: the first sofa in the world to feature a structure made exclusively of 100% polyurethane blocks, without the support of inner frames made from wood, metal, or other materials. By simply gluing together blocks of polyurethane foam, in fact, Willie Landels – Scottish painter and graphic artist, naturalized in Italy – had single-handedly created a sofa without any hard edges that might harm children.



Il rigore delle forme, l'*accoglienza* del decoro



The formality of forms, the hospitality of decorum



Kilt
Kilt 84

Design
Emaf Progetti
2006

Una morbida *scacchiera*



da comporre nello spazio

Chequered softness to compose in space



Botero

Design
Damian Williamson
2016

Per *una* persona, per *tante* persone;

per un *lungo* attimo di relax



*For one, for many;
for long moments of leisure*

Club

Design
Prospero Rasulo
2008

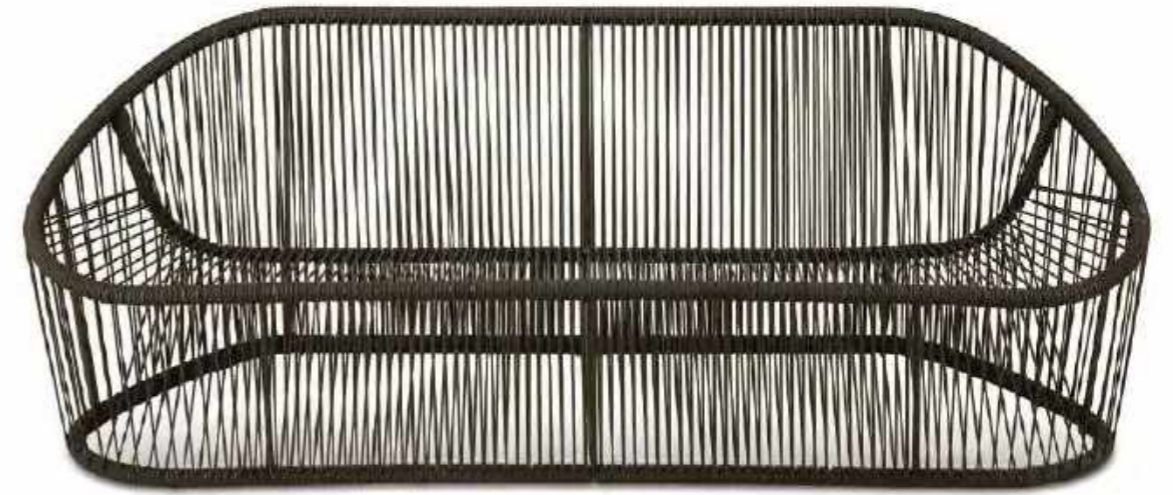

La *trasparenza* dell'aria,
un'anima outdoor



The transparency of air, the spirit of the outdoors

Parco

Design
Emaf Progetti
2011

Comodo sia *dentro* che *fuori*

Comfort inside and out



: IF YOU ARE NOT OBSESSED WITH YOUR LIFE...

Gianluca Vitiello

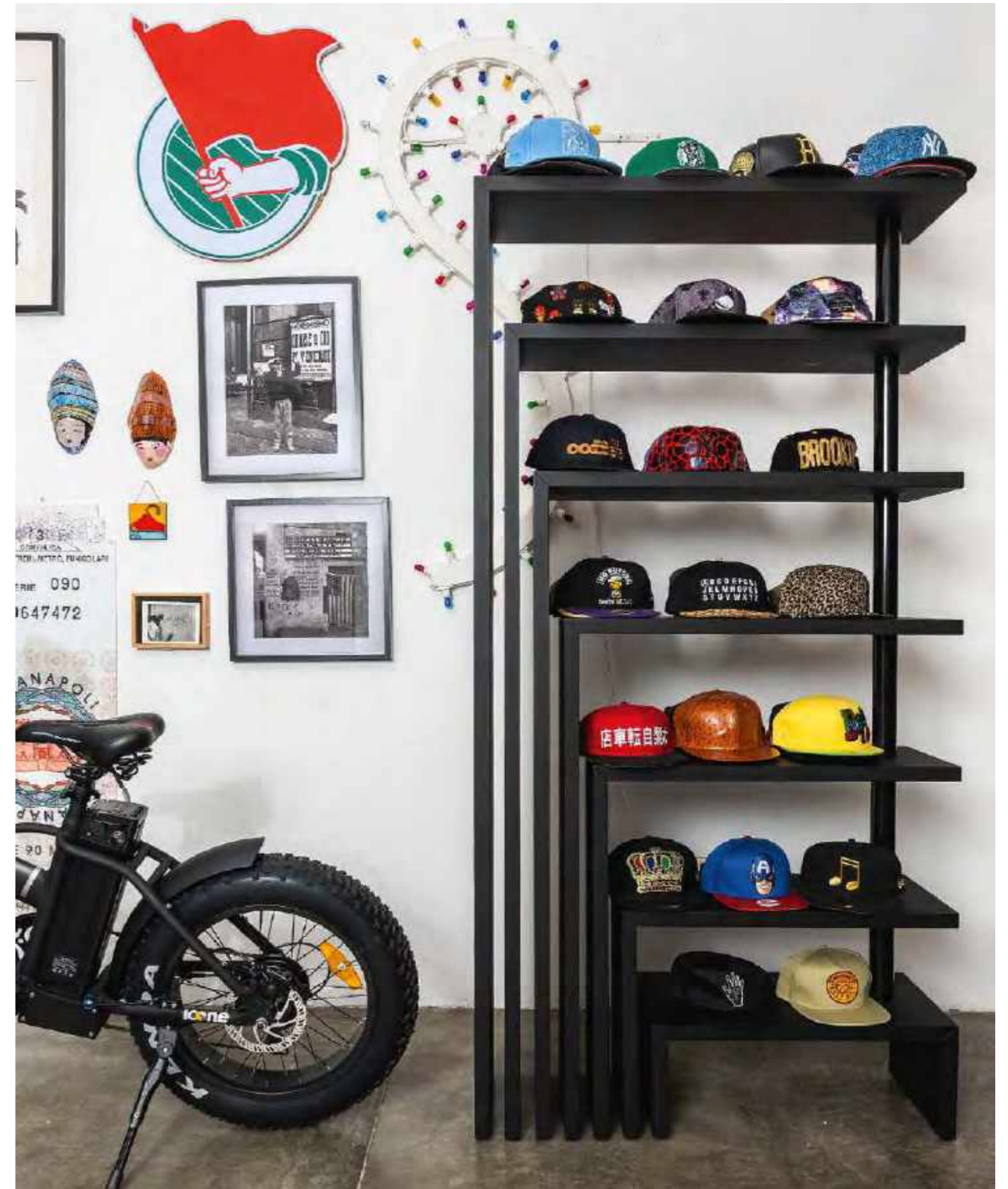

CHANGE IT.





: vivo la casa come uno spazio che possa raccontare quello che sono: un luogo in cui convivono la mia napoletanità e le mie radici, le mie passioni e la mia collezione di sneakers, gli oggetti provenienti dai miei viaggi con gli appunti di storie ancora da scrivere. Per ricordarmi che “casa” è ogni luogo dove mi “riconosco”.

: i live my home like a space that expresses who I am: a place inhabited by my Neapolitan nature and roots, my passions and my sneaker collection, objects from my travels with notes for stories that haven't been written yet. To remind me that "home" is every place where I "recognize" myself.





**: THE MORE YOU KNOW
THE LESS YOU NEED.**

Ludovica e Roberto Palomba





: una casa vissuta in piena libertà. Materiali tattili, anche sul pavimento realizzato con una particolare resina che abbiamo testato qui per la prima volta, una casa dove camminare scalzi, dove non ci sono barriere visibili. Tutto si riduce in pochi spazi e in poche funzioni dilatate: un grande divano da “vivere” che diviene così il vero centro della casa. Un divano da condividere con gli amici o nell’intimità quotidiana della famiglia. Pochi gli oggetti intorno, un grande tavolino *Quaderna* ed alcuni accessori di affezione.

*: a house lived in utter freedom. Tactile materials, even for the flooring made with a particular kind of resin that we tested here for the first time, a house for walking barefoot, without any visible barriers. Everything is reduced to very few spaces and several extensive functions: a large sofa to be “lived on”, so it becomes the centre of the home. A sofa to share with friends or for intimate, everyday family life. Very few objects around, one large small table (*Quaderna*) and a few beloved accessories.*





: living in a new house is kind of like starting anew, one selects what to bring along for the following years and this selection is a chance to take stock.

: abitare una nuova casa è un po' come una ripartenza, si seleziona ciò che si vuole portare per i prossimi anni ed in qualche modo questa selezione rappresenta una sorta di bilancio.

Dan | sedia, struttura grigio ferro, cinghie antracite / chair, iron grey frame, anthracite straps

Dan | sedia, struttura nera, cinghie corda / chair, black frame, string straps

Cumano | tavolino nero / black small table





**Ogni oggetto, ogni arredo,
è un compagno silenzioso.
Che sia un grande divano,
una sedia, un complemento,
o uno scrittoio di fronte
alla finestra, sono oggetti
distratti e quotidiani.
Quella distrazione che può
nascere solo dalla fiducia
e dalla confidenza e che fa
sentire lo spazio e gli arredi
che ci circondano parte
di noi stessi.**

*: every object, all furnishings, are silent companions.
Whether it is a large sofa, a chair, an accessory, or
a writing desk by the window, these are distracted daily
objects. The kind of distraction that only comes from trust
and the confidence we feel when the surrounding spaces
and furnishings have truly become a part of us.*

Tucano | scrittoio, piano cuoio 0814, struttura nera / desk, cowhide 0814 top, black frame

Tonietta | sedia, cuoio 0701, struttura nera / chair, cowhide 0701, black frame

112 Oliva | poltrona, tessuto Valente 27959, struttura nera / armchair, fabric Valente 27959, black frame

**: the more you know
the less you need**
è il motto degli aborigeni
australiani. In qualche modo
ci rendiamo conto che più
il tempo passa, più diventiamo
selettivi. Non è un modo
di escludere parti del nostro
passato, ma la possibilità
di dedicarci con più attenzione
a ciò che amiamo di più.

*: the more you know the less you need, this is
the motto of the Australian Aborigines.
In some way, we realized that the more time
passes, the more selective we become.
This is not to exclude parts of our past, but rather
a chance to dedicate ourselves more attentively
to what we love most.*



**Ahh, e ora relax...
Driiin (Sorry, I'll call you later).
Wow! LoL! Game over. C'era una volta...
Forme diverse tra loro, accoglienti,
a volte inaspettate, altre volte sinuose,
ma sempre progettate dalle persone
per le persone. La qualità delle nostre poltrone
vive proprio nella combinazione tra bellezza
e comodità: ergonomia e funzionalità non sono
mai lasciate al caso, anche nei progetti più arditi.
Le nostre poltrone sono così.
A ciascuno la sua.**

*Ahh, time to relax...
Ring ring (Sorry, I'll call you later).
Wow! Lol! Game over. Once upon a time...
Each has a different shape, welcoming,
sometimes unexpected, sometimes sinuous,
but all were designed by the people for
the people. The quality of our armchairs
is expressed in the combination of beauty
and comfort: ergonomics and functionality
are never overlooked, even in the most
daring designs. Our armchairs are just like that.
To each their own.*



Rider | 118 | 101



Sacco | 122 | 9, 27, 34, 105, 211, 214, 216, 221, 234, 342, 354, 384, 389



Maggiolina | 126 | 24, 364



Gilda CM | 132 | 29, 31



Genni | 136



Judy | 138 | 349



Ardea CM | 140 | 226



Sant'Elia | 142 | 334



Moretta | 144 | 344, 346, 351



Lama | 146 | 223



Louise | 150



Oliva | 152 | 112



Susanna | 154 | 82



Arom | 156



Calla | 159



Derby | 160



Kent | 162

Rider

Design
Ludovica+Roberto Palomba
2020

Take off your shoes and *relax*





La ricerca di un nuovo archetipo, sintesi di una tipologia di seduta solitamente formata da più componenti qui risolta in un elemento unico con movimento basculante. Un oggetto in equilibrio tra artigianalità e sofisticata tecnologia: un'anima sagomata in poliuretano rigido, imbottita e interamente rivestita a mano con un manto di cuoio naturale, cucito e formato sulla seduta stessa. La forma a sella che ne risulta è resa più morbida e accogliente da un materassino trapuntato a losanghe sottili, fissato alla struttura e rivestito in tessuto sfoderabile.

The quest for a new archetype, the synthesis of a type of seat that is usually formed with multiple components, is represented here in a single element that features a rocking movement. An object balanced between artisanship and sophisticated technology: a contoured core made from rigid polyurethane that has been padded and hand-covered with a sleeve of natural leather, sewn and formed directly on the seat itself. The saddle-shaped form that emerges is made even softer and more inviting by the slim diamond-quilted mattress attached to the structure, upholstered in removable fabric.

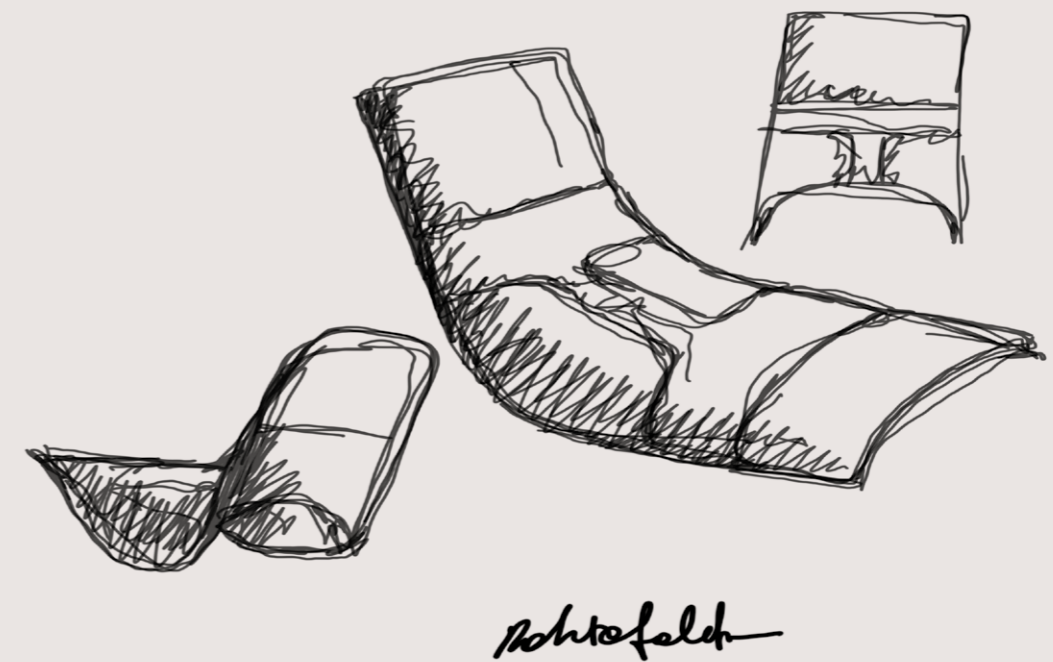

Sacco

Design
Gatti, Paolini, Teodoro
1968

P: Selezione Compasso d'Oro 1970; Premio BIO 5 Ljubljana 1973; Compasso d'oro alla carriera 2020.

C: The Museum of Modern Art, New York; Israel Museum, Jerusalem; Uměleckoprůmyslové Muzeum, Praha; Kunstgewerbemuseum, Berlin; Kunstmuseum, Düsseldorf; Museum für Angewandte Kunst, Köln; Taideteollisuusmuseo

Konstindustrimuseet, Helsinki; Musée des Arts Décoratifs, Paris; The Saint Louis Art Museum; Museo del Design 1880-1980, Milano; Museum für Kunst und Gewerbe, Hamburg; Denver Art Museum; Dallas Museum of Art; Fondazione Triennale Design Museum, Milano;

Tel Aviv Museum of Art; Vitra Design Museum, Weil am Rhein; Musée National d'Art Moderne, Paris; Thessaloniki Design Museum, Saloniki; Gustav Lübcke Museum, Hamm; Fonds Régional d'Art Contemporain, Dunkerque; LAB Museo del Design, fondazione

Anna Querci, Calenzano; Powerhouse Museum, Sydney; Museum für Angewandte Kunst, Wien; Design Museum, Gent; Philadelphia Museum of Art; Shiodomeitalia Creative Center, Tokyo; Musée des Arts Décoratifs, Bordeaux; Cité de l'Architecture & du Patrimoine,

Paris; National Gallery of Victoria, Melbourne; Musée de la ville de Saint-Quentin-en-Yvelines, Montigny-le-Bretonneux; Cooper Hewitt Smithsonian Design Museum, New York.

People love Sacco



Grande / Large



Medio / Medium



Piccolo / Small



Sacco | tessuto Pied de poule 64829 /
fabric Pied de poule 64829

Sacco | tessuto Vip 27557 / fabric Vip 27557
Sacco Medium | tessuto Vip 27514 / fabric Vip 27514
Sacco Small | tessuto Vip 27547 / fabric Vip 27547



tessuto Vip 27547 / fabric Vip 27547



tessuto Vip 27501 / fabric Vip 27501



tessuto Vip 27506 / fabric Vip 27506



tessuto Vip 27514 / fabric Vip 27514



tessuto Vip 27552 / fabric Vip 27552



tessuto Vip 27527 / fabric Vip 27527



tessuto Vip 27557 / fabric Vip 27557



tessuto Vip 27517 / fabric Vip 27517



tessuto Vip 27505 / fabric Vip 27505

Chi meglio di Sacco può interpretare la forza innovatrice del design italiano? A oltre 50 anni dalla sua nascita, Sacco è ancora oggi un progetto dirompente e rivoluzionario, simbolo di libertà e immaginazione. Sacco è universale per definizione, è disegnato per essere una seduta adattabile a qualsiasi persona e spazio, è un prodotto senza tempo, entra in ogni casa, è al di là delle mode e degli stili. Un esempio vero di good design, democratico, trasversale, innovativo, funzionale, bello, su cui sediamo "scomposti dal 1968". Nel 2020 Sacco (design Gatti, Paolini, Teodoro) vince il premio Compasso d'Oro alla Carriera.

Who better than Sacco could interpret the innovative force of Italian design? More than 50 years since its creation, Sacco is still a disruptive and revolutionary design to this day, a symbol of freedom and imagination. Sacco is universal by definition, designed to function as a seat that can be adapted to any person or space, a timeless product, for every home, beyond the fleeting nature of trends and styles. A true example of good design that is democratic, transversal, innovative, functional, beautiful, and upon which we have been sitting "disruptive since 1968". In 2020 Sacco (design by Gatti, Paolini, Teodoro) won the Compasso d'Oro Lifetime Achievement Award.

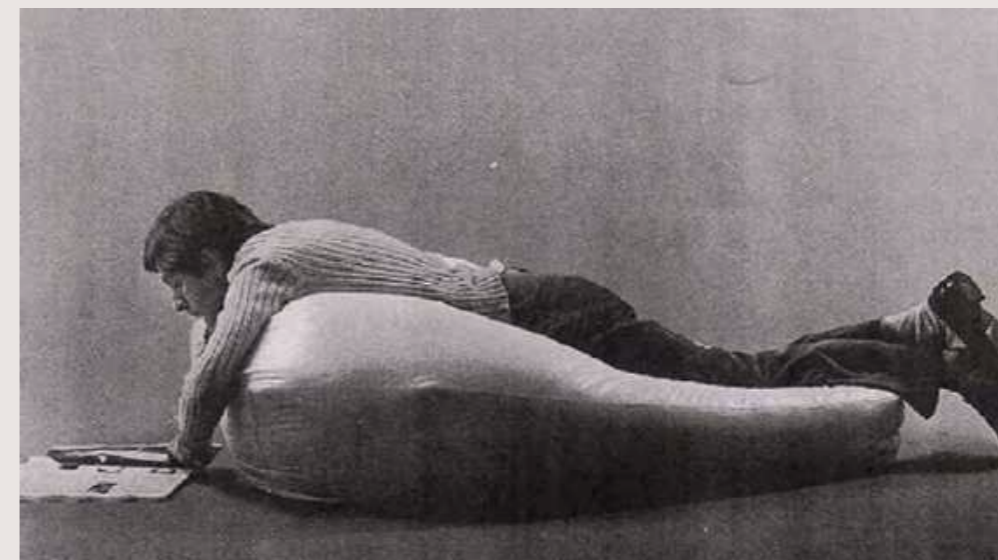

Maggiolina

Design
Marco Zanuso
1947

P: Medaglia d'Oro VIII Triennale,
Milano 1948. **C:** Die Neue Sammlung,
München.

Morbida come una *nuvola*
comoda come una *culla*

Soft as a cloud, comfortable as a cradle







Maggiolina | pelle Nappa 0306, scocca cuoio 0801, struttura nichelsatinata nero / leather Nappa 0306, cowhide sling 0801, black nickel-satin finished frame
pelle Nappa 0300, scocca cuoio 0800, struttura lucida / leather Nappa 0300, cowhide sling 0800, polished frame
pelle Extra 0479, scocca cuoio 0806, struttura nera / leather Extra 0479, cowhide sling 0806, black frame

Disegnata nel 1947 da Marco Zanuso, il grande progettista milanese, tra i primi a inaugurare il fenomeno del "buon design" italiano. Egli, infatti, avvertì alla fine degli anni '40 che le teorie funzionaliste secondo cui la forma dei prodotti è subordinata alla loro funzione dovevano lasciare il posto a una nuova concezione del progetto basata sul concetto di equilibrio tra forma e funzione. Nel progetto di Maggiolina, Zanuso abbandonò la tradizionale concezione della poltrona con la struttura imbottita e l'uso di tecniche artigianali, per sperimentare un nuovo sistema costruttivo pensato per la produzione industriale di serie. La ricerca del designer partì dall'evoluzione del metodo moderno, con la scomposizione funzionale degli elementi: tubo metallico curvato e verniciato, una scocca semirigida e due cuscini imbottiti. Quando Zanotta avviò la riedizione di Maggiolina nel 1972 lo fece partendo dalla versione originale riveduta con lo stesso autore.

Designed in 1947, by Marco Zanuso, the great Milanese designer, one of the first to introduce the phenomenon of Italian "good design". In the late 1940's he recognized, in fact, that the functional theories asserting that the form of a product was second to its function, would be replaced by a new conception of design, based upon the concept of balancing form and function. In the design for Maggiolina, Zanuso abandoned the traditional armchair concept, consisting of a padded structure and the implementation of artisanal techniques, to experiment with a new system of construction envisioned for industrial serial production. The designer's research began with the evolution of the modern method, by the functional deconstruction of the elements: varnished curved metal tube, a semi-rigid shell and two padded cushions. When Zanotta launched the new edition of the Maggiolina, in 1972, he based it upon the initial version, revisited with the original designer.





1. Conversare
2. Leggere
3. Riposare
4. Sognare

1. Converse
2. Read
3. Rest
4. Dream



È davvero un bell'omaggio questa attenta ricostruzione filologica che Zanotta ha realizzato della poltrona Gilda, che sembra superare per qualità costruttive le possibilità che lo stesso Carlo Mollino aveva praticato nel 1953, quando alle prese con l'arredamento di casa Pomella aveva disegnato due poltrone gemelle con schienale reclinabile, contraddistinte da una struttura di legno massello sagomato e scolpito, con due elementi imbottiti per sedile e schienale, entrambi conformati tra scelte linguistiche ed ergonomiche, e con sistemi di fissaggio e regolazione in metallo realizzati su disegno. Oggi il dettaglio "in più", reso possibile soprattutto dal desiderio di sottolineare fino in fondo la lezione del maestro, è l'elemento bracciolo/gamba posteriore costruito virtuosamente in un pezzo unico (e non più giuntato come nell'originale realizzato dai pur bravissimi artigiani di Mollino), soluzione che regala un'ulteriore bellezza scultorea a quest'oggetto, onorandolo di ulteriore pregio.

Zanotta paid true philological tribute in the careful reconstruction that led to his Gilda armchair, which seemingly surpasses the construction possibilities employed by Carlo Mollino in 1953 when, while furnishing casa Pomella, he designed two paired armchairs with a reclining backrest. The structure was characterized by the distinctive solid wood frame, curved and sculped, with two padding elements on the seat and backrest. The chairs express a selection of linguistic and ergonomic choices, with custom-designed metal systems which could be fastened and adjusted. Today, the "added" detail – primarily due to the desire to best highlight the master's lesson – is the fact that the armrest/rear leg is now virtuously hewed from a single piece (no longer spliced like the original crafted by Mollino's superb artisans). This new solution offers enhanced sculptural beauty to this object, further honouring it with added prestige.



morbida
ma rigorosamente controllata

Soft, but rigorously controlled



È l'oggetto più complesso e ricco di implicazioni progettuali nella serie di mobili disegnati da Mucchi intorno al 1935, modelli completamente nuovi attraverso l'uso della tecnologia del tubo d'acciaio curvato. La qualità formale del progetto è esemplare per quanto riguarda le idee strutturali e di funzionamento in essa concentrate. Paragonata ad oggetti della stessa tipologia prodotti dal design razionalista nel suo periodo "eroico", Genni si distingue per la maggiore attenzione alla comodità, con poggiatesta e regolabile in due posizioni; per una notevole semplificazione formale e contemporaneamente per una forte carica espressiva ed "architettonica".

Of all of the furniture series designed by Mucchi around 1935 – which featured utterly new designs thanks to the use of curved metal technology – this object is the most complex and rich with design implications. The formal allure is exemplary in terms of the structural ideas and functionality concentrated within. Compared to objects of a similar kind produced by rational designers of the that "heroic" era, Genni stands out for the greater attention to comfort, as it was equipped with a headrest and the ability to be adjusted into two positions; and for its remarkable formal simplification paired with impressive "architectural" expressiveness.



Quanto alla propaganda, di cui si è parlato ieri, il mio desiderio esplicito, anzi condizione, è che sia usato solo il nome ~~Genni~~ Mucchi e non Architetto Mucchi. Gli architetti fanno le architetture (e io ne ho fatte), non le sedie. Le sedie forse le fanno dei designer. Ma io non sono un designer, sono soltanto, con cordiali saluti

il suo Mucchi

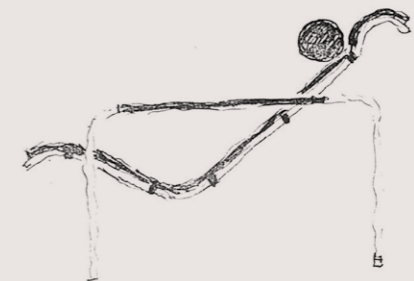

OPPURE: bisogna che ci mettiamo io e Lei e il suo tappezziere a studiare la struttura che sia adatta a ricevere il materassino senza dargli il garbo di cui parlo. P.e. così :

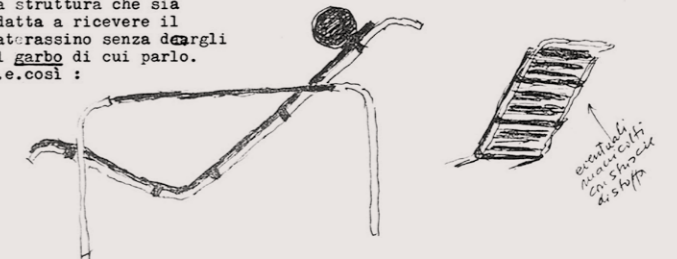

Ne parli con i Suoi collaboratori che saluto cordialmente

M.

Judy

Design
Frank Rettenbacher
2017



Un guscio *accogliente*

A gracious shell



"È stata un'evoluzione naturale trasferire conoscenza ed esperienza acquisite su una scala più ampia. Lo schienale imbottito con braccioli estesi crea una custodia protettiva, che invita a sederti e rilassarti. Sperimentando diversi spessori dell'impiallacciato abbiamo raggiunto la perfetta flessibilità dello schienale per adattarlo al corpo." cit. Frank Rettenbacher
Judy oltre ad offrire un elevato comfort offre anche un'ampia possibilità di scelta: dal legno dello schienale, al colore delle gambe in acciaio verniciato, oltre che sperimentare accostamenti cromatici fra bellissimi tessuti e pelli.

"It was a natural evolution to transfer my gained knowledge and experience to a larger scale. The padded backrest with extended armrests creates a protective shell, an invitation to recline and relax. By experimenting with plywood of various thicknesses, we found the perfect flexibility for the backrest to adapt to the body".
In addition to offering optimal comfort, Judy is also replete with opportunities to choose from: from the wood used for the backrest, to the colour of the varnished metal legs, and the possibility to experiment with beautiful pairings of fabrics and leathers.

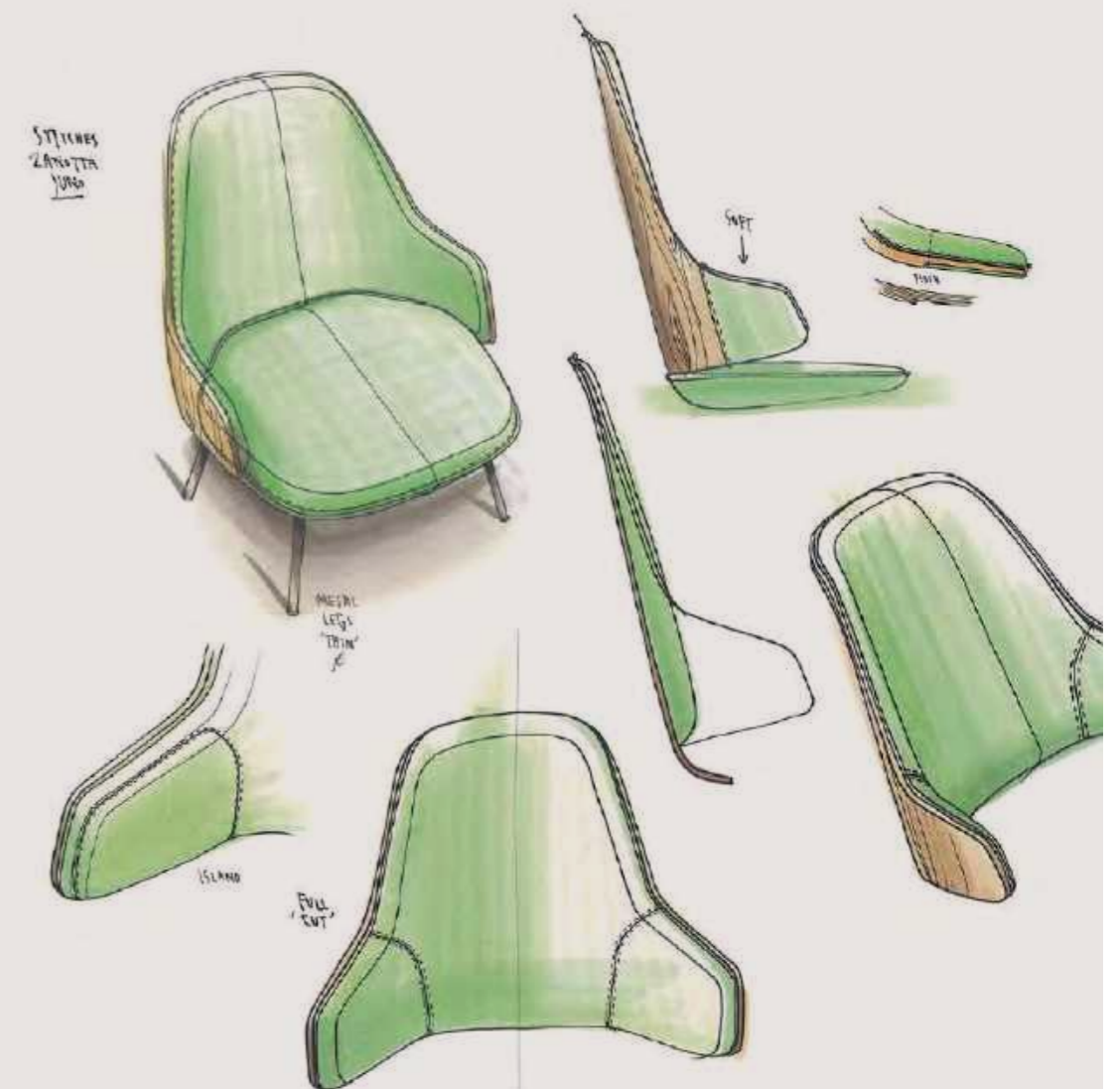

Una bergère
su cui *abbandonarsi*



A bergère for carefree indulgence



sinuosità di una seduta sospesa

A sinuously suspended seat



Giuseppe Terragni, ritenuto il padre del Razionalismo italiano, progettò tra il 1932 e il 1936 una serie di mobili per la Casa del Fascio di Como, che comprendeva tavoli, scrivanie, poltroncine e sedie destinate ai diversi ambienti dell'edificio. Fra questi ricordiamo la sedia Lariana e la poltroncina Sant'Elia connotate dalla stessa originale idea: quella di staccare in modo evidente lo schienale dalla seduta, lavorando sull'elasticità e quindi sulla comodità dei due elementi, ottenuti sfruttando la flessione del tubolare metallico della struttura.

Nel 1936 gli venne commissionato il progetto dell'Asilo Sant'Elia di Como per il quale continuò gli studi fatti per gli arredi della Casa del Fascio, dando vita a una seduta per bambini, da cui vennero sviluppati altri studi volti alla ricerca di una forma più confortevole e adatta a diversi utilizzatori, la cui evoluzione scaturì nel progetto della poltroncina Sant'Elia così come la conosciamo oggi.

Giuseppe Terragni, considered the father of Italian Rationalism, designed a series of furnishings between 1932 and 1936 for the Casa del Fascio, in Como. This collection included tables, desks, armchairs and chairs designed for different locations in the building. Among these, we remember the Lariana chair and Sant'Elia armchair, which shared the same original idea: to detach the back rest from the seat in a very evident manner, working with elasticity and the comfort of the two elements, by exploiting the flexibility of the tubular metal structure.

In 1936, he was commissioned to design the Sant'Elia nursery school, in Como, which led him to further develop his studies for the furnishings of Casa del Fascio. He therefore created a chair for children, striving to find the most comfortable form, which would be suitable for diverse users. The subsequent evolution of these concepts sparked the design of the Sant'Elia armchair as we know it today.

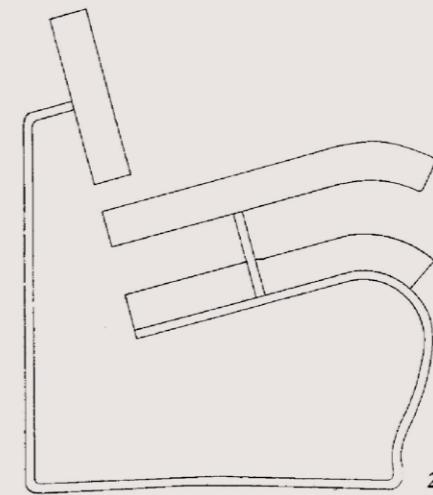

28

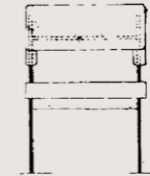
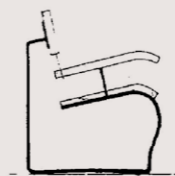

SCALA-1 A 10 - POLTRONCINA

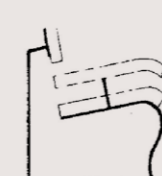

POLTRONCINA SCALA 1:10



SEDLA 1 A 10



PARTICOLARE SEDIA 1 A 5



Moretta

Design
Bernard Marstaller
1917

Questione *d'incastri*

A question of convergences



Progettata all'inizio del secolo scorso (1917) da Bernard Marstaller, Moretta, elegante reinterpretazione dell'oggetto "coloniale", incarna un nuovo linguaggio e tutta la bellezza degli oggetti smontabili, ripiegabili, richiudibili e disarticolati che hanno in sé prerogative di economicità, flessibilità e praticità.

Designed at the beginning of the last century (1917), by Bernard Marstaller, Moretta represents an elegant re-interpretation of the "colonial" object, the incarnation of an all-new language and the beauty of objects that can be disassembled, collapsed, folded up and disarticulated and can boast economical, flexible and practical benefits.



Lama

Design
Ludovica+Roberto Palomba
2006

Una forma, *libere* interpretazioni



One form, open interpretations





Struttura

architettonica



Architectural structure



Eleganza *informale*

Informal elegance



Susanna

Design
Gabriele Mucchi
1983



La comodità si *regola*

The comfort to adapt



Arom

Design
Noé Duchaufour Lawrance
2014



Sartorialità
contemporanea

Contemporary tailoring

Arom | pelle Extra 0414, scocca cuoio 0714 / leather Extra 0414, cowhide sling 0714
tessuto Vins 27705, scocca cuoio 0707 / fabric Vins 27705, cowhide sling 0707
tessuto Pied de poule 64830 / fabric Pied de poule 64830



Arom | tessuto Vins 27705, scocca cuoio 0707 / fabric Vins 27705, cowhide sling 0707
Servomuto | tavolino / service table

Noé Duchaufour Lawrance seguendo le orme del padre scultore, ha iniziato presto a seguire il suo orientamento artistico. Cresciuto in un ambiente creativo ha definito in modo connotato il suo linguaggio che utilizza forme naturali per raggiungere linee morbide ed organiche, fluide e allo stesso tempo strutturate, come vere sculture. "L'insieme delle curve e delle cuciture raccontano la ricchezza di un savoir-faire, ma anche la sensualità e la forza di un mondo organico. Questo dualismo tra forza e sensibilità è l'immagine stessa dell'oggetto".

Noé Duchaufour Lawrance, following in the footsteps of his father, a sculptor, started out his own artistic endeavors at a young age. Growing up in a creative environment defined the nuances of his language, which utilizes natural forms to create soft, organic lines which are fluid, yet structural, like true sculptures. "Together, the curves and stitching express all the richness of a certain savoir-faire, but also the sensuality and strength of an organic world. This dualism between strength and sensitivity is the image of the object itself".

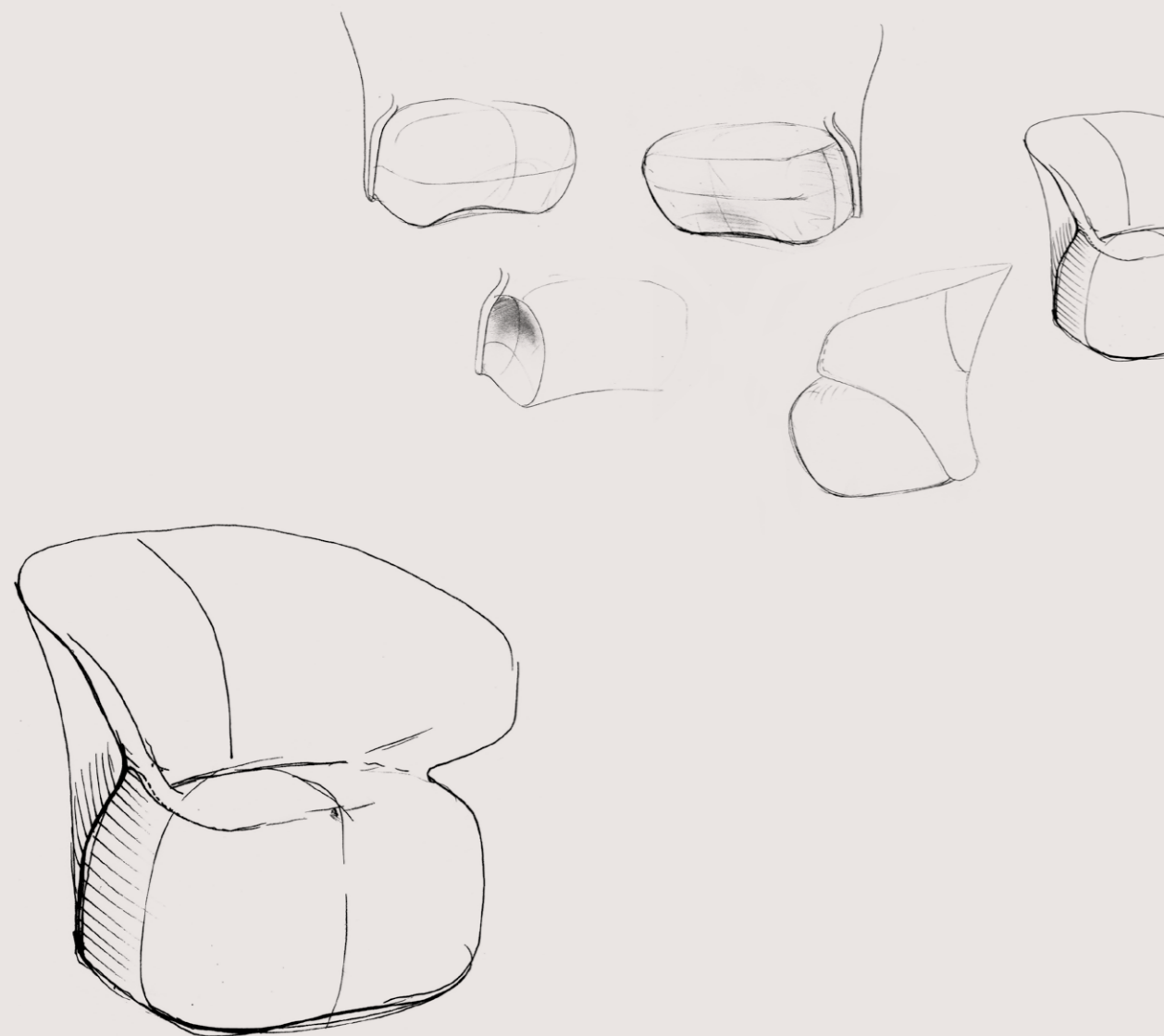

Calla

Design
Noé Duchaufour Lawrance
2010



Classica *naturalalezza*

Classic natural ease



Calla | tessuto Torre 32101 / fabric Torre 32101
scocca cuoio 0701 / cowhide sling 0701
tessuto Torre 32101 / fabric Torre 32101
pelle Nappa 0300, scocca cuoio 0701 / leather Nappa 0300, cowhide sling 0701

Derby

Design
Noé Duchaufour Lawrance,
2009-2010

Avvolgente come un *sogno*

Enveloping like a dream



Kent

Design
Ludovica+Roberto Palomba
2013

Eleganza, con *grinta*

Elegance, with attitude



Una poltroncina, una bergère con schienale alto e un pouf con base girevole, Kent, nelle tre declinazioni di prodotto è un oggetto imbottito tra il vintage e il futuristico. Una seduta per il salotto contemporaneo, ma che potrebbe essere stata ideata vent'anni fa, come pure un secolo prima perché le qualità delle forme e dei materiali sono in qualche modo iconiche e classiche.

An armchair, a bergère with a high backrest, and a pouf with a swivelling base, in all three versions Kent is a padded object that falls somewhere between vintage and futuristic. A seat for contemporary living rooms, but it could have been designed twenty years ago, or even 100, because the quality of the forms and materials are somehow iconic and classic.



Tavolini, comodini, sottoconsolle /

Small tables, night tables, benches

Appoggia lì il bicchiere!

Ti ricordi dove ho lasciato gli occhiali?

Bello questo libro... ora, però, buona notte.

Il telefono è là dentro in carica.

Spesso oggetti piccoli richiedono soluzioni tecniche importanti che, grazie alla qualità dei materiali e alla sapienza nelle lavorazioni, risultano quasi invisibili. A volte ci piace essere discreti, contenuti. Quasi puntiformi. Ma utili.

Rest your glass there!

Do you remember where I put my glasses?

I love this book...but for now, good night.

The phone's charging in there.

Small objects often require important technical

solutions which, thanks to high quality materials

and clever craftsmanship, make them nearly invisible.

Sometimes we like to be discrete, contained. To the point.

But useful.



Graphium | 166 | 109



Niobe | 170 | 11, 12, 70, 82, 231



Servomuto | 174 | 70, 83, 89, 100, 157



Quaderna Tavolino | 176 | 107, 300, 383



Echino | 178 | 386



Cumano | 180 | 74, 89, 111, 128, 145



Butterfly | 184



Arabesco CM | 186



Spotty | 188



Girò | 190



Toi | 191



Loto Ninfea | 192 | 95



Basello | 194



Sgabillo | 196 | 337



Tempo | 198 | 71, 74



Tod | 199 | 371



Zeus | 200 | 22



Teti | 201 | 22



Carlino CM | 202 | 25



Oscar | 204 | 377



Taschino | 206 | 346, 348



Simmetria naturale

Natural symmetry





Niobe

Design
Federica Capitani
2016



Form follows nature



Marmo Emperador /
Emperador marble

Marmo bianco di Carrara /
white Carrara marble

Marmo nero Marquinia /
black Marquinia marble





172 Niobe | piano marmo bianco di Carrara, struttura bianca / white Carrara marble top, white frame



Servomuto

Design

Achille Castiglioni

della serie Servi

di Achille & Pier Giacomo Castiglioni

1974

C: Kunstgewerbemuseum,
Berlin; Museum für Angewandte
Kunst, Köln; Museum für Kunst
und Gewerbe, Hamburg; Dallas
Museum of Art; Fondazione

Triennale Design Museum,
Milano; Thessaloniki Design
Museum, Saloniki; M.A.X.
Museo, Chiasso.

Al momento *giusto*, al posto *giusto*

At the right time, at the right place



Il Servomuto ha segnato un importante momento non solo nella storia della produzione Zanotta ma anche in quella del design italiano conquistandosi il ruolo di archetipo di un'inedita tipologia di oggetti di servizio. Il suo progetto è derivato da quello di altri due prodotti - un posacenere e un portaombrelli - che i fratelli Achille e Pier Giacomo Castiglioni avevano ideato nel 1961 appositamente per l'arredo della leggendaria Birreria Splügen di Milano. A quella del Servomuto seguì poi la produzione di altri complementi che andarono a formare la famosa famiglia dei Servi: Servopluvio, Servofumo, Servomoste, Servomanto, Servonotte, Servietto, Servotutto...

Servomuto marked an important moment not only in the production history of Zanotta, but for Italian design as a whole, earning the role as an archetype for an all-new kind of service objects. The design was derived from two other products - an ashtray and an umbrella holder - that brothers Achille and Pier Giacomo Castiglioni had created in 1961, especially to furnish the legendary Splügen Beer House, in Milan. After the Servomuto, additional products were produced, forming the famous Servi (servant) family: Servopluvio, Servofumo, Servomoste, Servomanto, Servonotte, Servietto, Servotutto...



Quaderna Tavolino

Design
Superstudio
1970

P: Medaglia d'Oro Mostra Internazionale M.I.A. 1971.

C: Israel Museum, Jerusalem; Museum für Angewandte Kunst, Köln; Kunstgewerbemuseum, Berlin; Kunstmuseum, Düsseldorf; Denver Art Museum;

Fondazione Triennale Design Museum, Milano; Musée National d'Art Moderne, Paris; The Museum of Modern Art, New York.

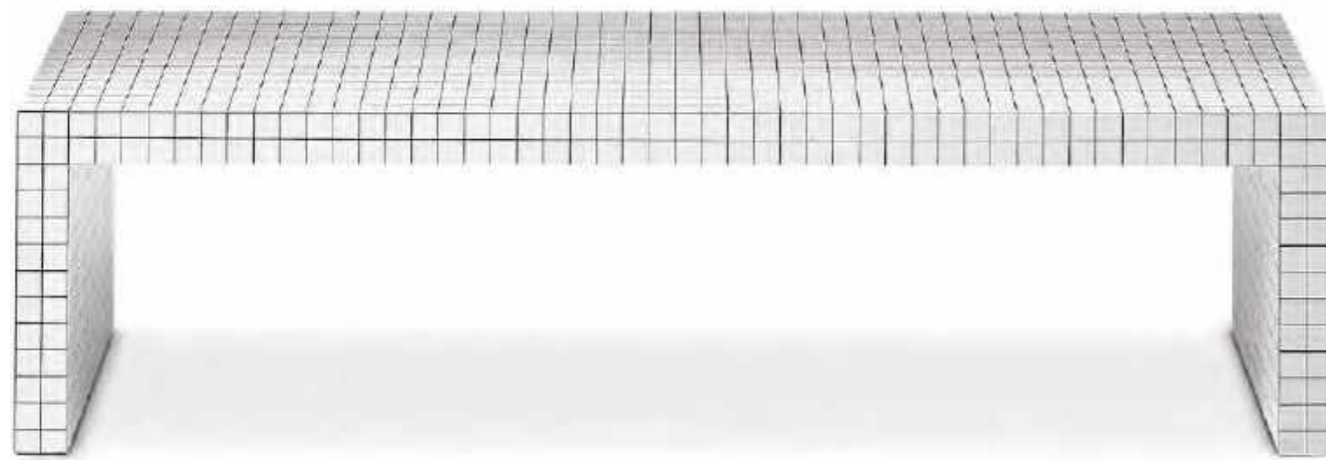

Paesaggio a quadretti

Squared environment





Luce e *materia*

Light and matter



Echino | piano nichelsatinato nero, gambe vetro ambra / black nickel-satin finished top, amber glass legs
piano nichelsatinato nero, gambe vetro fumé / black nickel-satin finished top, smoky grey glass legs
piano nichelsatinato nero, gambe vetro fumé / black nickel-satin finished top, smoky grey glass legs
piano cristallo a specchio, gambe vetro azzurro / mirror glass top, light blue glass legs
piano nichelsatinato nero, gambe vetro fumé / black nickel-satin finished top, smoky grey glass legs

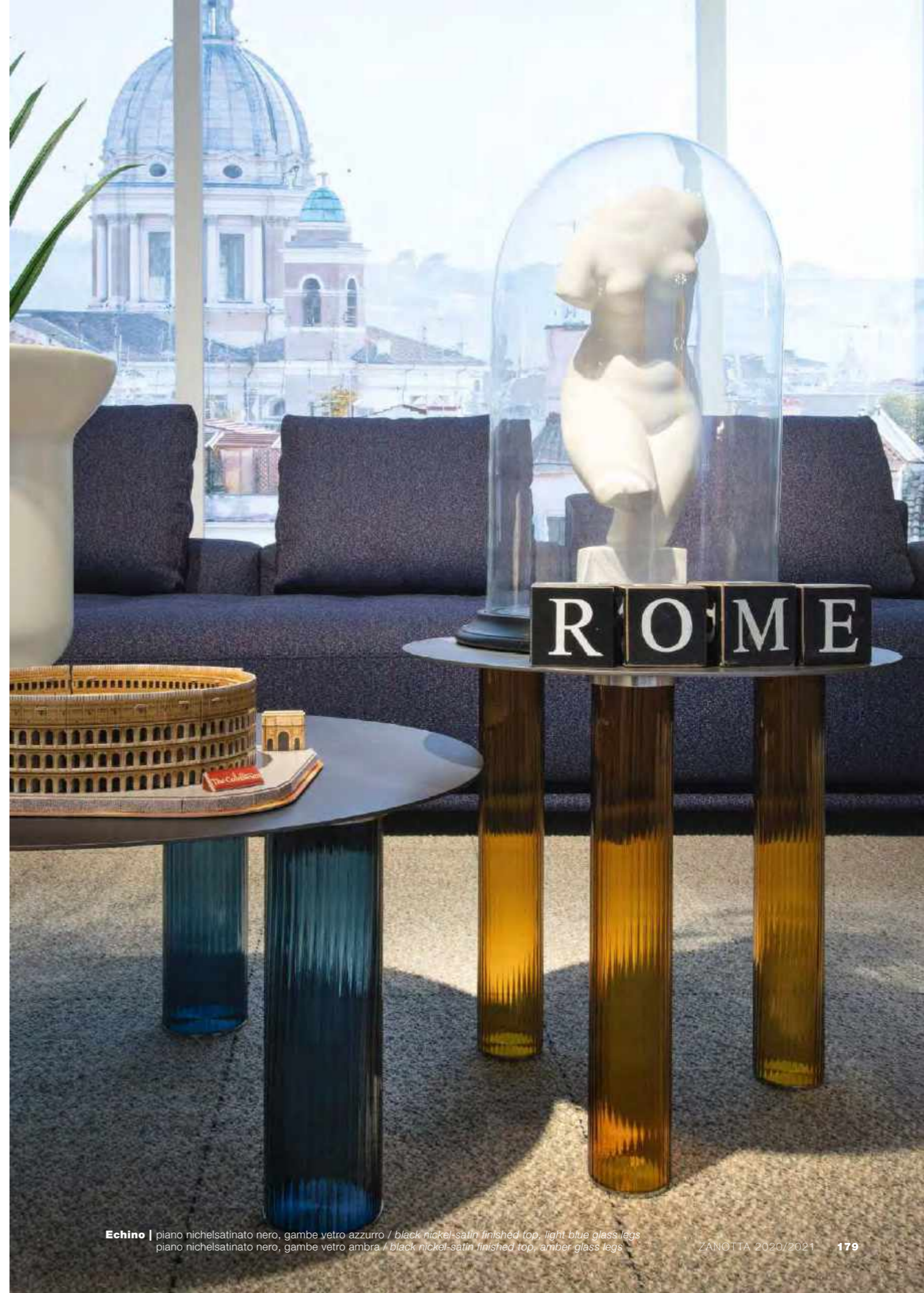

Echino | piano nichelsatinato nero, gambe vetro azzurro / black nickel-satin finished top, light blue glass legs
piano nichelsatinato nero, gambe vetro ambra / black nickel-satin finished top, amber glass legs

Cumano

Design
Achille Castiglioni
1978

P: Selezione Compasso d'Oro
1981.

C: Die Neue Sammlung, München;
Israel Museum, Jerusalem;
Kunstgewerbemuseum, Berlin;
Museum für Kunst und Gewerbe,
Hamburg; Fondazione Triennale
Design Museum, Milano;
Thessaloniki Design Museum,
Saloniki; Fond National d'Art
Contemporain, Paris; The Saint
Louis Art Museum; Indianapolis
Museum of Art.

Aperto, chiuso, *appeso*



Open, closed, hanging



Il progetto di questo tavolino parte dal desiderio di rivisitare il disegno di un archetipo di fine Ottocento appartenente alla tipologia dei tavolini per esterno pieghevoli. Nel re-design di questo pezzo, Castiglioni concentra l'attenzione sugli elementi di dettaglio per perfezionare ed esaltare la funzionalità del prodotto. A questo proposito, per la realizzazione del giunto di scorrimento delle gambe utilizza un materiale autolubrificante come il nylon, migliorando così sensibilmente le operazioni di apertura e chiusura. Il foro introdotto nel piano permette poi di appendere il tavolino a parete.

The design for this table was sparked by the desire to revisit the plan of an archetype from the late 1800's, which fell into the outdoor folding table category. When re-designing this piece, Castiglioni focused his attention on the detail elements to perfect and enhance the product's functionality. To do so, he used nylon, a self-lubricating material for the slip joint on the legs, thereby vastly improving its ability to open and close. The hole located on top allows the table to be hung up on the wall.

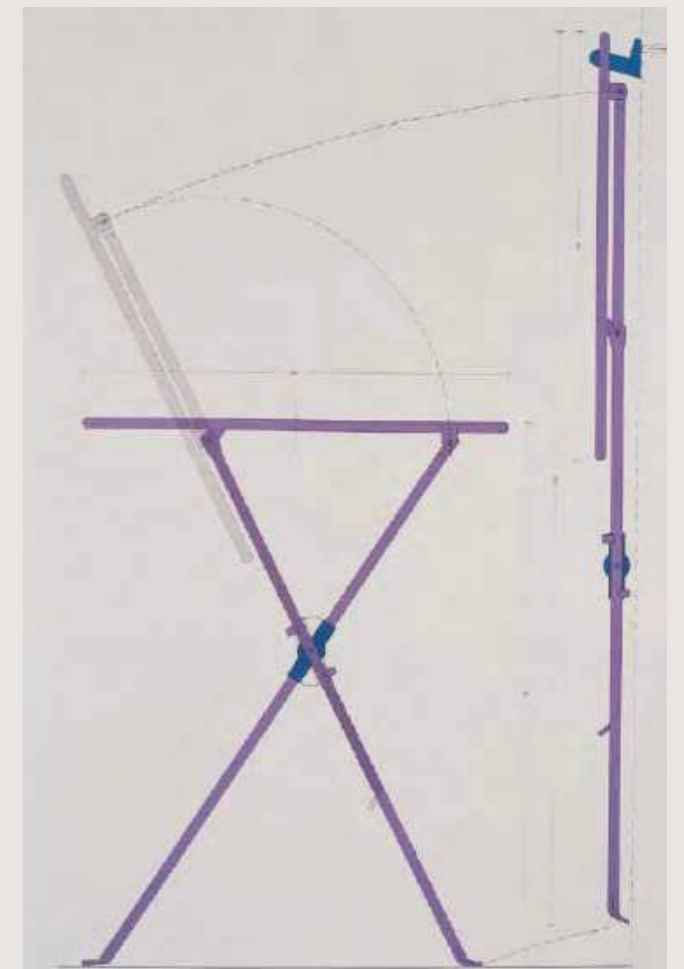

Butterfly

Design
Alexander Taylor,
Zanotta-E&Y Co-Edition
2006

P: Good Design Award 2006.



Leggerezza *in volo*

Lightness in flight

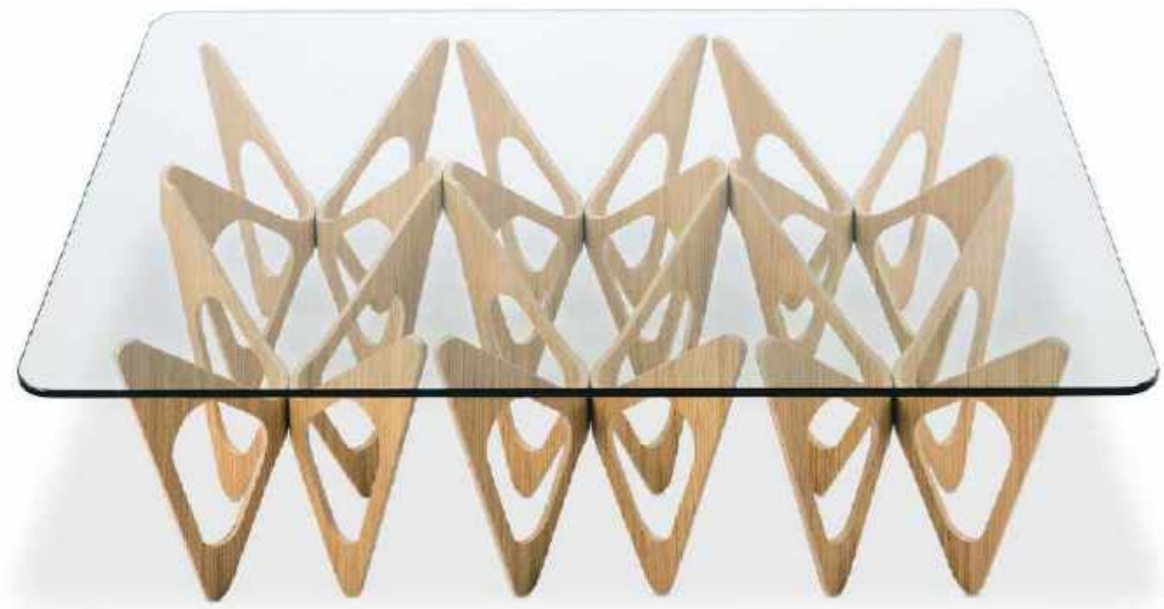

Arabesco CM

Omaggio a
Carlo Molino
1949

C: Die Neue Sammlung,
München; Fondazione Triennale
Design Museum, Milano.



Lo stile *plasma* la tecnica

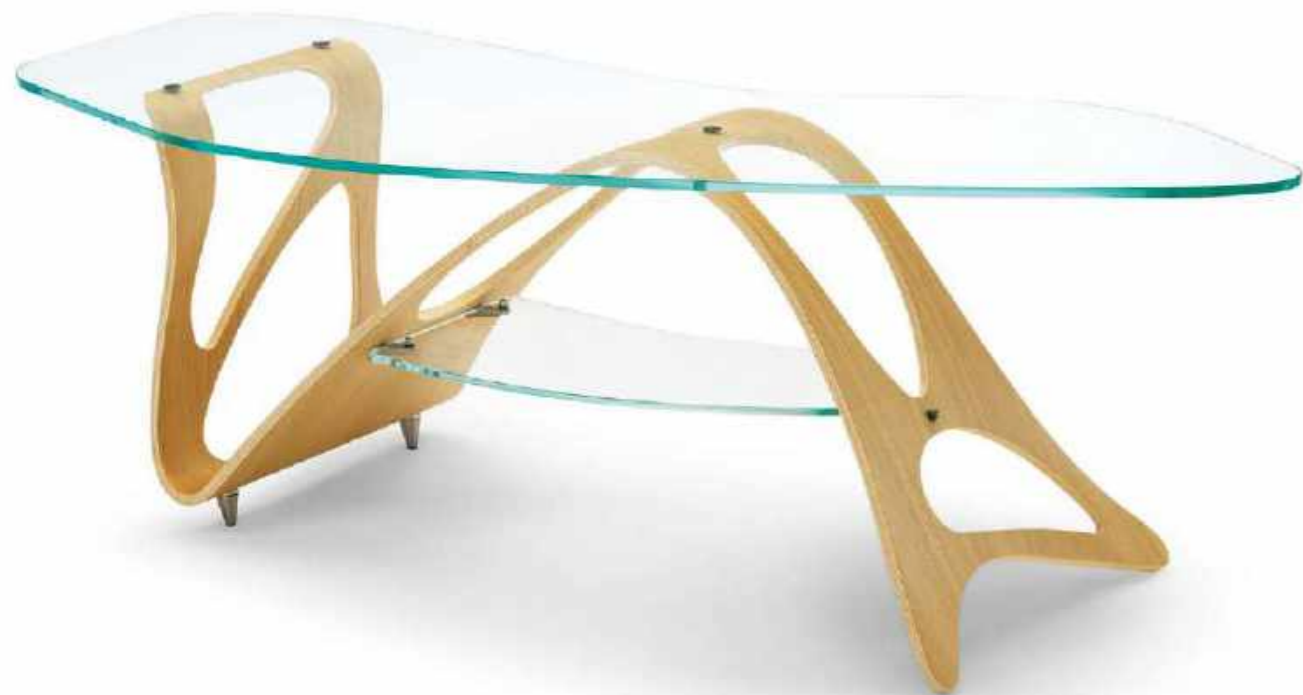

Style bends technique



Spotty

Design
Pierre Charpin
2019



Dot, dot, dot



Girò

Design
Anna Deplano
1997, 1999

L'elogio del cerchio

An ode to the circle



Toi

Design
Salvatore Indriolo
2012

P: Young & Design 2012.

Top secret



Loto
Ninfea

Design
Ludovica+Roberto Palomba
2009

P: New Classic Award Schöner
Wohnen 2010.

La natura *sissuna* le forme

Nature whispers form



Basello

Design
Achille Castiglioni
1987



L'idea che non c'era

The idea that wasn't



Basello è un "oggetto d'invenzione" nato dal pensiero di uno tra i più autorevoli maestri del Design italiano, Achille Castiglioni. Un "gradino" ("basel" in milanese) che può fungere da sgabello o piano d'appoggio. Due elementi di diversa altezza – uno a U, piede dell'oggetto, l'altro a L – sono collegati da uno snodo cilindrico, che permette la reciproca apertura con qualsiasi angolazione. Questo concetto si è evoluto in seguito nel progetto del mobile Joy, dove Castiglioni persegue l'idea dell'azzeramento tecnologico e formale, creando un oggetto "neutro" a funzione multipla, possibile archetipo di una nuova tipologia.

Basello is an "invented object" born from the idea of one of the most authoritative masters of Italian Design, Achille Castiglioni. A "step" (or "basel" in Milanese dialect) that can be used as a stool or a tabletop. Two elements of different heights – the U-shaped one forming the foot, and an L-shaped one – are connected by a cylindrical joint that allows it to be opened to any angle. This concept was further evolved in the design for Joy, where Castiglioni continued to pursue the idea of technological and formal annihilation, by creating a "neutral" multi-purpose object, a possible archetype for a whole new typology.



Sgabillo

Design
Max Bill
1950

C: Kunstgewerbemuseum,
Zürich; Kunstgewerbemuseum,
Berlin; Kunstmuseum,
Düsseldorf; Israel Museum,
Jerusalem; Thessaloniki Design

Museum, Saloniki; Die Neue
Sammlung, München.



Prêt-à-porter



Sgabillo | struttura betulla naturale / natural birch frame
struttura MDF verniciato nero / black lacquered MDF frame

Lo sgabello Sgabillo fu disegnato da Max Bill nel 1950 per l'arredamento degli alloggi degli studenti della Hochschule für Gestaltung di Ulm, famosa scuola tedesca per il design di cui Bill fu fondatore e direttore. Partendo da una ferma difesa dei principi della Bauhaus, Max Bill fu il principale teorizzatore di un movimento neo-funzionalista che attraverso lo slogan "Die gute Form" (la buona forma) prese un atteggiamento di forte dissenso nei confronti dello Styling americano che considerava, al pari dell'ornamento, inutile esercizio formale. Per Bill la forma doveva derivare ed interpretare al meglio la funzione degli oggetti industriali.

The Sgabillo stool was designed by Max Bill, in 1950, to furnish one of the student accommodation facilities at the Hochschule für Gestaltung at Ulm, the famous German design school of which Bill was the founder and director. Starting with a staunch defense of Bauhaus principles, Max Bill was the primary theorist of a neo-functional movement for which the slogan, "Die gute Form" (the good form) was representative of the dissenting attitude towards American Styling that he considered, along with ornament, a useless formal exercise. For Bill, form had to derive from and best interpret the function of industrial objects.



Tempo

Design
Prospero Rasulo
2001

P: ADI Design Index 2002.

La forma del *tempo*
Time takes shape



Tod

Design
Todd Bracher
2005

Equilibrio asimmetrico
Asymmetric equilibrium



Zeus

Design
Prospero Rasulo
2006

Piccole *sculture* domestiche



Teti

Design
Prospero Rasulo
2006



Small domestic sculptures





L'intrigante

punto di equilibrio



Balanced intrigue

Oscar

Design
Emaf Progetti
2005

La linea del *vuoto*, la forma del *pieno*



The line of emptiness, the form of fullness

Taschino

Design
Gabriele Rosa
2017

Un segreto *in-vano*

Vainly kept secrets



Taschino | piano e cassetto cuoio 0813, struttura grafite / top and drawer cowhide 0813, graphite frame
piano e cassetto cuoio 0811, struttura bianca / top and drawer cowhide 0811, white frame
piano e cassetto cuoio 0814, struttura grafite / top and drawer cowhide 0814, graphite frame





**: SEMPRE
SALVA
LA FANTASIA.**

: above all imagination.

Marco Bernocchi

Tonietta | sedia, cuoio 0714, struttura nera / chair, cowhide 0714, black frame
Reale CM | tavolo, piano cristallo extra chiaro, struttura rovere tinto nero /
table, extra-clear plate glass top, black painted oak frame



Reale CM | tavolo, piano cristallo extra chiaro, struttura rovere tinto nero /
table, extra-clear plate glass top, black painted oak frame

Tonietta | sedie, cuoio 0714, struttura nera / chairs, cowhide 0714, black frame

Sacco | poltrona, tessuto Vip 27527 / easy chair, fabric Vip 27527

Follia | sedia / chair

Aster | appendiabiti nero / black clothes-stand

Mezzadro | sgabello bianco / white stool

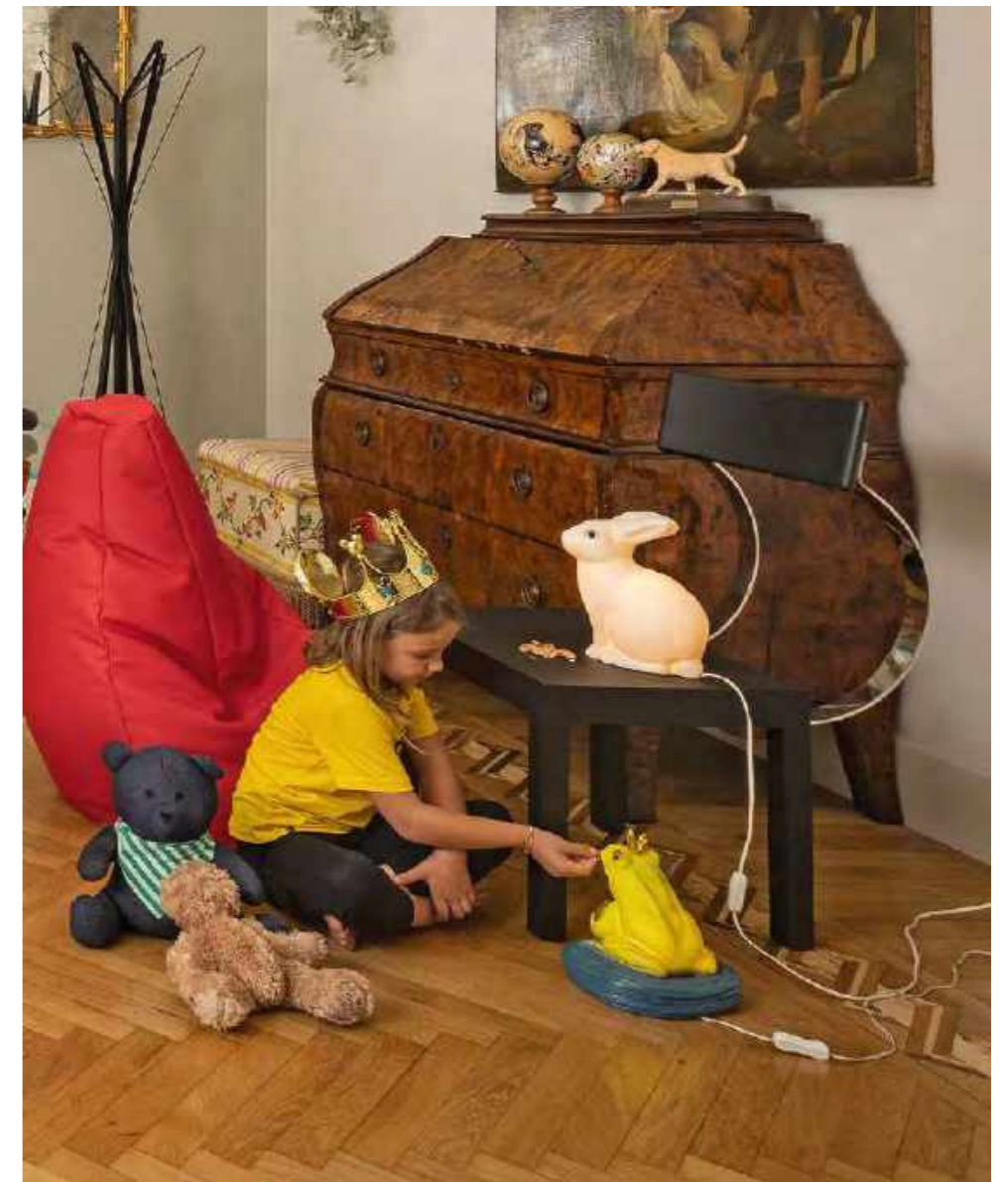

**: little creatures
live here.**



: viaggiando su una nuvola.

: travelling on a cloud.



: ispirazioni naturali.

: natural inspirations.





**: LA CASA
È L'EMANAZIONE DI SÈ,
LA CASA È LA MEMORIA
DEL TUO FUTURO.**

*: home is the emanation of self,
the memory of your future.*

Piero Gemelli



**: il luogo dove i ricordi
trovano concretezza
negli oggetti collezionati,
negli arredi, nei quadri
o nelle fotografie...
e tra quegli oggetti,
scorre la tua vita
e si costruisce il tuo futuro.**

*: it is the place where memories take shape in the collection of objects,
furnishings, paintings or photographs...and among those objects,
your life unfolds, and your future is built.*







**: la casa è la traccia
del tuo vissuto, è lo specchio
di chi tu sei.**

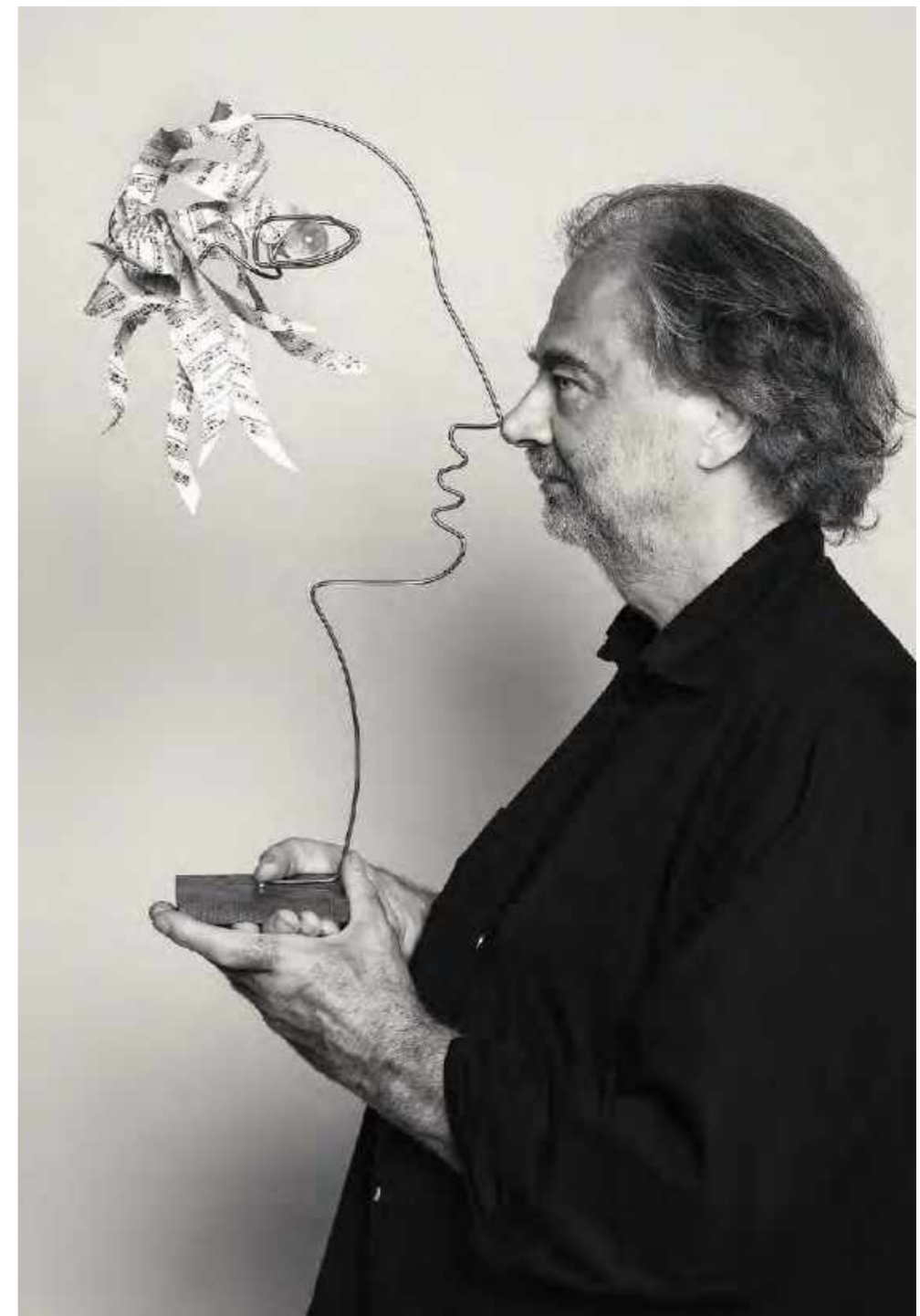

*: the home contains the traces of your life;
it is the mirror of who you are.*



**: SIAMO COMPLICI DI QUESTE
MURA TRAFORATE DA APERTURE
SULLA CITTÀ.**

*: we are the accomplices of these walls
punctuated by openings towards the city.*

Sandra Casagrande e Roberto Recalcati

Nena | poltroncina, tessuto Quinoa 32256, struttura grafite / *small armchair, fabric Quinoa 32256, graphite frame*
Nena | poltroncina, pelle Super 0953, struttura grafite / *small armchair, leather Super 0953, graphite frame*

228 Tweed | tavolo, rovere tinto nero / *table, black painted oak*







**: palcoscenico della nostra vita,
dove i nostri dipinti nascono
e restano solo per un po'.**

*: this is the stage of our life, where our paintings
are born and remain for a little while.*

Quattro gambe (a volte tre), un sedile (quello sempre) e uno schienale (a volte sì, a volte no). Il progetto più semplice e difficile allo stesso tempo, sia dal punto di vista progettuale sia da quello di significato. E poi tessuti, strutture, giunti, imbottiture: nessun elemento è lasciato al caso per far sì che le nostre sedie non siano solo belle, ma anche comode e funzionali. Pensiero, ricerca, lavoro; ogni volta per noi è una scommessa. Talvolta un azzardo. Da sempre.

Four legs (sometimes three), a seat (always a must) and a back rest (maybe so, maybe not). Even the simplest design has its difficulties, both from the design point of view and the significance. Then there are the fabrics, frames, joints, padding: no element is overlooked, so our seats are not just beautiful, but also comfortable and functional. Intuition, research, work; for us, each time it's a new challenge. It might even be risky. As always.



Dan | 238 | 17, 19, 111



Dan | 242 | 225



Nena | 244 | 228, 230, 233, 390



Toniotta | 248 | 112, 209, 210, 216



Lia | 252 | 309



Lea | 254



Talia | 256



Lialta | Lealta | 258



April | 260 | 331, 390, 395



June | 262



Elipse | 266



Tusa | 270



Liza | 272



Celestina | 274 | 352, 353



Fenis CM | 276 | 70



Noli | 278



Lord | 280



Leo | Lio | 281



Ido | 282 | 329

Una struttura essenziale:
da configurare e personalizzare



Dan | struttura grigia, cinghie antracite / grey frame, anthracite straps
struttura nera, cinghie gialle / black frame, yellow straps
struttura nera, cinghie blu / black frame, blue straps



Dan | struttura grigia, cinghie corda / grey frame, string straps
struttura nera, cinghie gialle / black frame, yellow straps
struttura nera, cinghie blu / black frame, blue straps
struttura grigia, cinghie antracite / grey frame, anthracite straps

An essential structure – to configure and customize



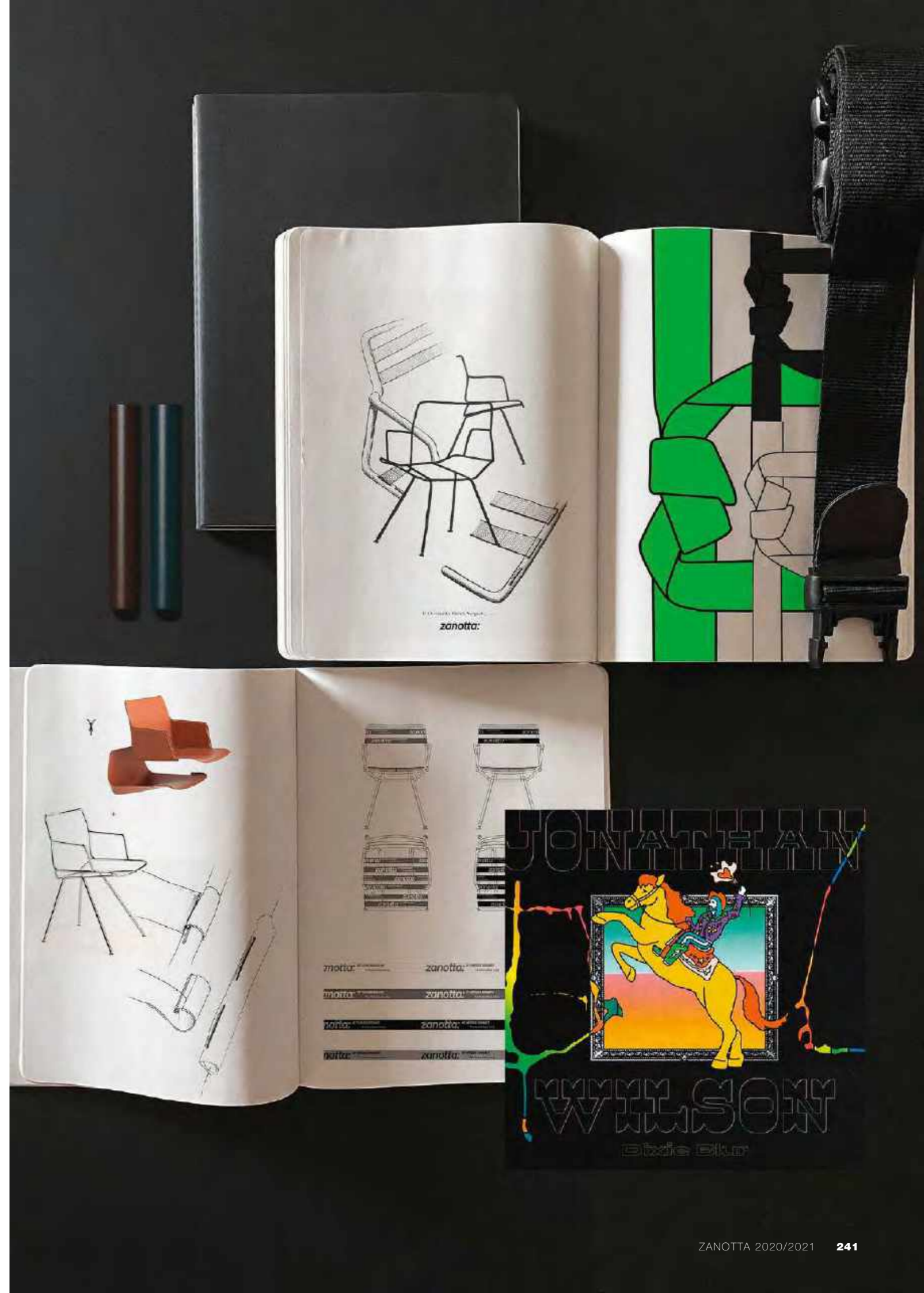

Dan

Design
Patrick Norguet
2020



Nena

Design
Lanzavecchia+Wai
2020

Hug me!





Tonietta

Design
Enzo Mari
1985

P: Premio Compasso d'Oro
1987; 1° Premio Chair Fair
International Design Center New
York 1986.

C: Taideteollisuusmuseo
Konstindustrimuseet, Helsinki;
Fondazione Triennale Design
Museum, Milano; Thessaloniki
Design Museum, Saloniki; The

Museum of Modern Art, New
York; Los Angeles County
Museum of Art.

La sintesi *tecnicia*
diventa bellezza *estetica*



*Technical essence
engenders aesthetic beauty*





Un vero progetto di Industrial design: un unico stampo per le quattro gambe, la sintesi tecnica diventa bellezza estetica, l'essenza del progetto crea un nuovo archetipo.

La sedia Tonietta è il felice esempio di un prodotto nato da una stretta e fertile collaborazione tra azienda e designer. Iniziato nel 1981, il progetto della Tonietta termina nel 1985 dopo un'intensa attività di ricerca ingegneristica resasi necessaria per poter utilizzare una tecnologia, quella della pressofusione dell'alluminio, costosa e fino ad allora poco sperimentata per la realizzazione della struttura di una sedia domestica.

"Ero particolarmente insofferente verso la moda che voleva oggetti, e fra questi anche le sedie, sovraccarichi di arroganze progettuali di natura tecnologica o tipologica: volevo disegnare una sedia il più semplice possibile, quasi ovvia, non un oggetto diverso a ogni costo, e dopo un'attenta analisi ho visto che fra le sedie moderne le Thonet sono quelle che meglio incarnano l'idea di immagine archetipica, e così per definire il carattere della mia sedia ho scelto di dialogare con questo unico esempio di oggetto alto-borghese, carico di valenze semantiche e simboliche". Nel 1987 la sedia Tonietta vince il prestigioso Premio Compasso d'Oro con questa motivazione della giuria:

"Per la grande lezione di stile e di cultura espressa nella realizzazione di questa sedia, con l'intenzione di richiamare alla memoria un archetipo, senza imitarne banalmente gli elementi morfologici."

A proper industrial design project: a single mould is used for the four legs, hence technical synthesis becomes aesthetic beauty, the essence of the project creates a new archetype.

The Tonietta chair is a successful example of a product born from close and fertile company-designer collaboration. The design for Tonietta began in 1981, and finally came to conclusion in 1985, after a period of intense engineering research required in order to utilize a particular technology: aluminium die casting, which was expensive and, up to that point, underexploited for the creation of the domestic chair frame.

"I was particularly irritated by the trend which required that objects, including chairs, be overloaded with technological or typological arrogance in their design. I wanted to design the simplest chair possible, nearly obvious, not an object that had to be different at all costs. After careful analysis, I saw that the modern chairs by le Thonet are the ones that best incarnate the archetypical imagery, so I decided to converse with this single high-bougeois example when defining the character of my chair, as it was so rich with semantic and symbolic value."

The Tonietta chair won the prestigious Compasso d'Oro Award in 1987 with the following motivation of the jury: "This chair represents a great lesson on style and culture - it calls to mind an archetype, avoiding all trite imitations of morphological elements".

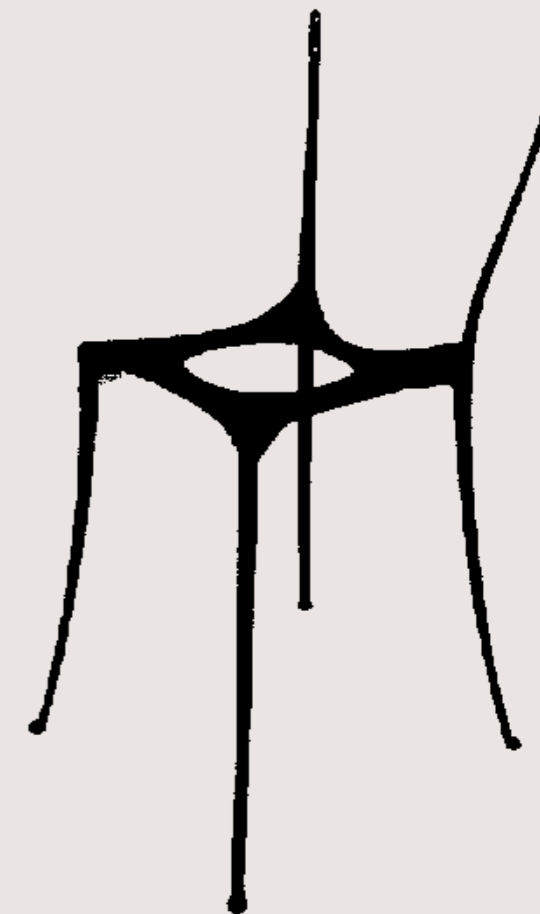
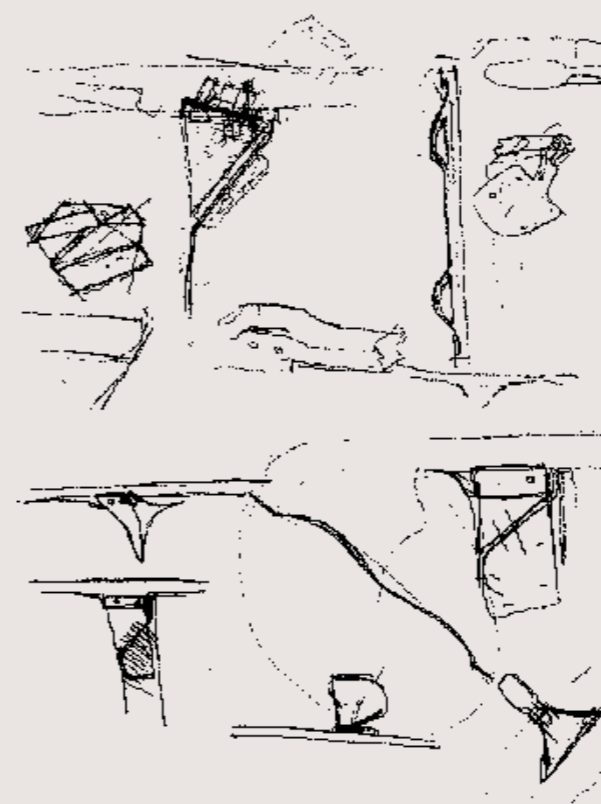

Lia

Design
Roberto Barbieri
1998-1999

P: ADI Design Index 1998 - 1999. C: Vitra Design Museum, Weil
am Rhein.

Forma *minima* comodità *assoluta*

Minimal form, absolute comfort



Lea

Design
Roberto Barbieri
2003



Talia

Design
Roberto Barbieri
2007



Lialta
Lealta

Design
Roberto Barbieri
2006



April

Design
Gae Aulenti
1964

C: Uměleckoprůmyslové
Muzeum, Praha; Fondazione
Triennale Design Museum,

Milano; Fond National d' Art
Contemporain, Puteaux; Musée
National d'Art Moderne, Paris.

Sofisticata praticità

Sophisticated practicality



"Cose minimali è molto difficile che le faccia perché io non cerco il minimalismo, semmai la semplicità che è una cosa molto differente." Sono le parole di Gae Aulenti che con questa sedia pieghevole che un po' mima l'iconica sedia da regista, porta il suo tocco architettonico in un oggetto dal risultato semplice ma tecnicamente sofisticato.

"It is very unlikely for me to do minimal things, because I do not seek minimalism, but rather, simplicity, which is a very different thing." These are the words of Gae Aulenti, who mimicked the iconic director's chair with this folding chair, infusing an object with her architectonic touch, for a result that is simple, yet technically sophisticated.

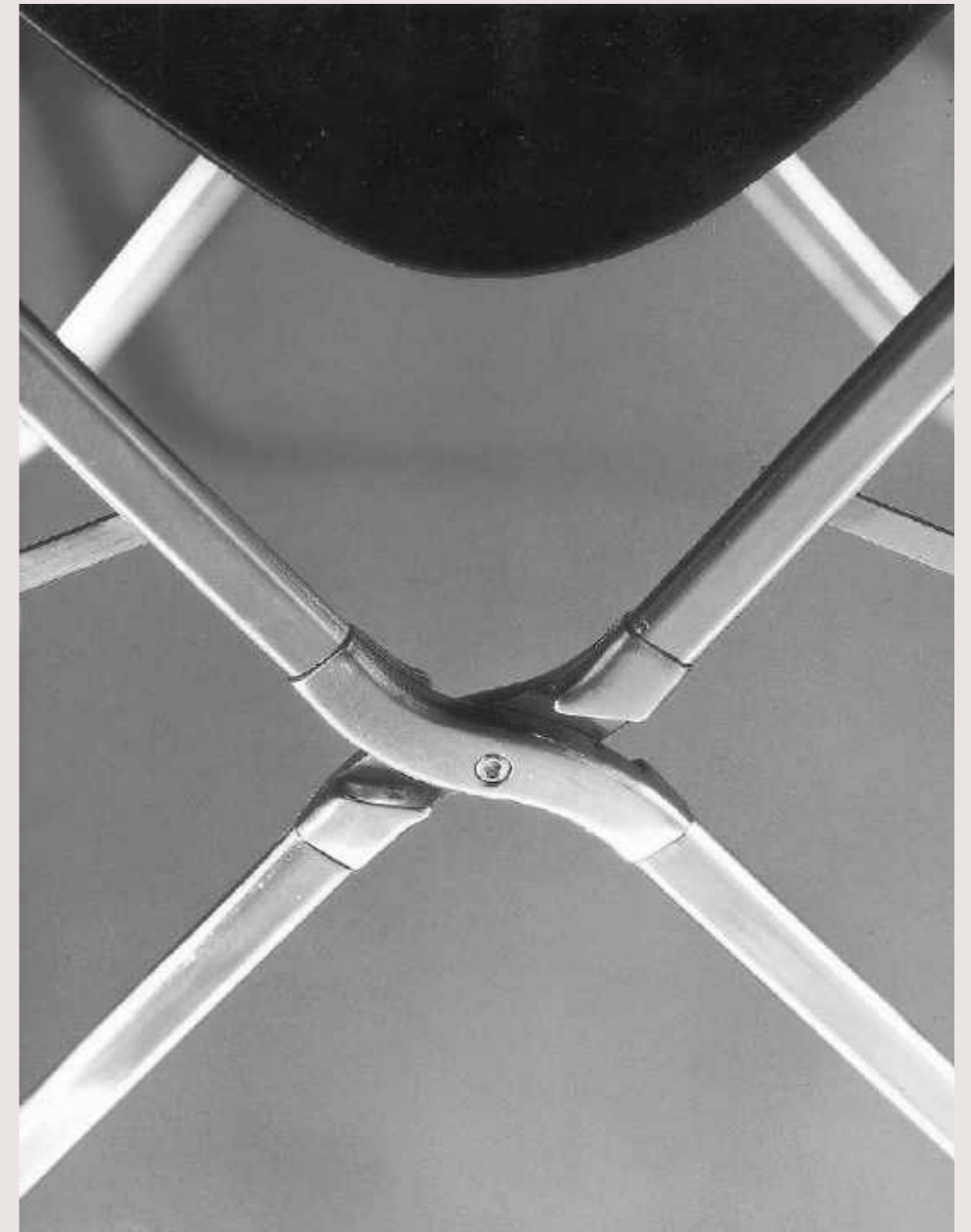

June

Design
Frank Rettenbacher
2016



Leggera e *resistente*

Light and resilient

June | schienale rovere naturale, seduta tessuto Quadrifoglio 27023 e 27027, struttura bianca /
natural oak backrest, seat fabric Quadrifoglio 27023 and 27027, white frame
schienale noce Canaletto, seduta pelle Extra 0411, struttura nera / Canaletto walnut backrest, seat leather Extra 0411, black frame

June | schienale rovere tinto nero, seduta pelle Nappa 0306, struttura nera /
black varnished oak backrest, seat leather Nappa 0306, black frame
schienale noce Canaletto, seduta pelle Nappa 0306, struttura nera /
Canaletto walnut backrest, seat leather Nappa 0306, black frame



264 **June** | schienale rovere naturale, seduta tessuto Quadrifoglio 27023 e 27027, struttura nera /
natural oak backrest, seat fabric Quadrifoglio 27023 and 27027, black frame **Santiago** | tavolo / table



Solida



Funzionale



Radicale



Saltorea



Solid, functional, radical, sculptural



"Elipse concilia la razionalità di un oggetto funzionale di industrial design e la potenza di un pezzo scultoreo radicale." Elipse colpisce per l'approccio giocoso e divertente, che ne fa un oggetto ironico ed empatico. La struttura tubolare a sezione squadrata le conferisce eleganza, leggerezza e carattere. Volutamente in contrasto con la struttura, la seduta e lo schienale disegnano linee curve e morbide forme per garantire comfort e sostegno. L'elemento caratterizzante del progetto è il foro circolare realizzato al centro dello schienale che permette una facile presa e diventa un punto focale di virtuosismo costruttivo espresso nel raccordo della struttura.

"Elipse pairs the rationality of a functional object of industrial design with the strength of a radical work of sculpture." Elipse is captivating for its playful and entertaining approach, which makes it an ironic and empathetic piece. The tubular structure in squared sections gives it elegance, lightness and character. In a deliberate contrast with the frame, the seat and back rest form curved lines and soft shapes to ensure comfort and support. The defining characteristic of the design is the circular hole in the center of the back rest, which makes the chair easy to pick up, and becomes a focal point of the virtuosic construction expressed in the structure's joints.



Tusa

Design
Rodolfo Dordoni
2019



La sapiente *gentilezza* delle forme

The masterful grace of forms

Liza

Design
Lievore, Altherr, Molina
2015



Essenziale con garbo

Essential, with poise



Liza | tessuto Quadrifoglio 27048, gambe noce Canaletto / fabric Quadrifoglio 27048, Canaletto walnut legs
scocca nera, seduta tessuto Quadrifoglio 27006, gambe nere / black sling, seat fabric Quadrifoglio 27006, black legs
scocca bianca, seduta tessuto Pied de poule 64804, gambe lucide / white sling, seat fabric Pied de poule 64804, polished legs



Liza | tessuto Tito 31805, gambe noce Canaletto / fabric Tito 31805, Canaletto walnut legs **Reale** | tavolo / table

Celestina

Design
Marco Zanuso
1978

C: The Design Museum,
London; Fondazione Triennale
Design Museum, Milano; Vitra
Design Museum, Weil am Rhein.



Innovativo *déjà-vu*

Innovative déjà-vu



Questa è la sedia per antonomasia. Leggera ed essenziale, impreziosita da dettagli come la struttura realizzata con un profilo rettangolare in acciaio che si torce in alcuni punti e il rivestimento in cuoio con eleganti borchie in rame e cuciture a contrasto su sedile e schienale. Sul finire degli anni Settanta fu intrapresa una nuova via di ricerca volta ad individuare e recuperare dal passato oggetti di origine anonima, "già visti", ma da rivisitare e riproporre in chiave contemporanea. In quest'ottica, nel 1978 fu proposto a Marco Zanuso di occuparsi del ridisegno di una "familiare" sedia pieghevole per esterni il cui modello era stato trovato in un negozio di mobili usati. Interpretando al meglio il concetto del re-design, Zanuso introduce col suo progetto delle migliorie per esaltare le caratteristiche funzionali e il comfort della seduta. Per quest'ultima propone una soluzione molto raffinata rivestendo le doghe in nylon, originariamente in lamiera, con un materiale nobile e pregiato come il cuoio.

This is the quintessential chair. Light and essential, embellished with details like the steel frame with a rectangular profile that twists in several places and the leather cover with elegant copper studs and contrast stitching on the seat and back rest. At the end of the 1970's a new approach to research was undertaken, whereby anonymous objects from the past, which had "already been seen", were selected and recuperated so they could be revisited in a contemporary key. To this end, in 1978, Marco Zanuso was asked to redesign a "familiar" outdoor folding chair that had been found in a used furniture shop. In his optimal interpretation of the redesign concept, Zanuso introduces several improvements in his design to enhance the functional aspects and the comfort of the seat. To do so, he proposes a very refined solution; he covers the nylon slats - originally in sheet metal - with a prized and noble material, leather.



Una scultura *scavata* nel legno



A sculpture carved from wood

Una sedia che è una scultura: interamente scavata dal massello di acero, il suo schienale si innesta nelle gambe creando un gioco di eleganti incastri, nella continuità delle forme.

Progettata nel 1959 per il suo ufficio al Castello del Valentino, sede della Facoltà di Architettura di Torino, Fenis è il primo progetto di Mollino che Zanotta decise di produrre nel 1981: una scelta d'avanguardia, ardita, che superava le frontiere dell'arredo per approdare a quelle dell'arte.

A seat that is true sculpture: entirely carved from solid maple wood, the back rest is joined to the legs to create an elegant interplay, through the continuity of the forms.

Designed in 1959 for his office at the Castle of Valentino, which houses the University of Turin's School of Architecture, Fenis is the first of Mollino's designs to be produced by Zanotta, in 1981: an avant-garde and bold decision, which crossed the boundaries of furnishings to approach the world of art.

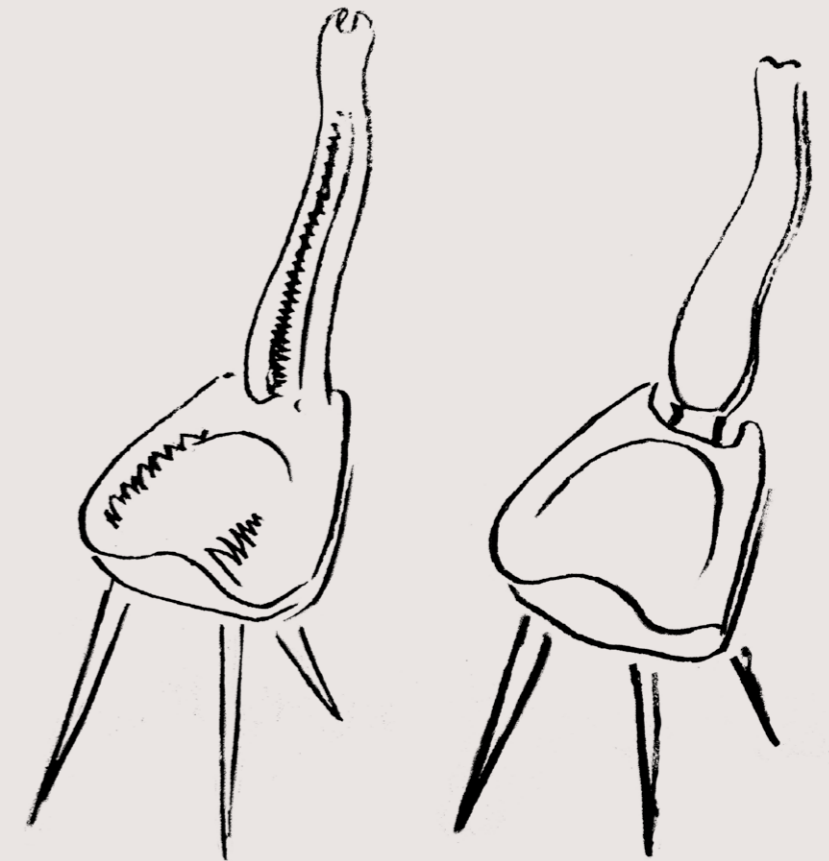

Noli

Design
Ludovica+Roberto Palomba
2018

La *convivialità* a colori

Colourful conviviality



Noli | tessuto Quadrifoglio 27023, struttura rosa mattone / fabric Quadrifoglio 27023, rose-brick frame
tessuto Tito 31803, struttura grigio cenere / fabric Tito 31803, ash-grey frame
tessuto Tito 31805, struttura antracite / fabric Tito 31805, anthracite frame

Noli | tessuto Tito 31841, struttura verde salvia / fabric Tito 31841, sage-green frame
tessuto Quadrifoglio 27057, struttura blu mare / fabric Quadrifoglio 27057, navy blue frame
tessuto Quadrifoglio 27013, struttura senape / fabric Quadrifoglio 27013, mustard frame

Lord

Design
Alfredo Häberli
2003



Leo
Lio

Design
Roberto Barbieri
2005

Movimenti su misura

Made-to-measure movements



Ido

Design
Frank Rettenbacher
2016

L'eleganza della *geometria* pura

The elegance of pure geometry



Ogni tavolo è un sottile equilibrio di elementi diversi sapientemente combinati: materiali naturali o compositi, forme geometriche o più libere, lavorazioni tecnologiche o interventi manuali. Sul tavolo, intorno al tavolo, la vita di tutti i giorni: dei pennarelli, un libro, un computer, il pranzo appena servito, dei giocattoli, un disegno, un contratto, un amante. Sul tavolo, intorno al tavolo.

Every table is a subtle balance between diverse elements that have been masterfully combined: natural materials or composites, geometric or more free-formed, technological manufacturing or manual craftsmanship. On the table, around the table, everyday life takes place: markers, a book, a computer, freshly served lunch, toys, a drawing, a contract, a lover. On the table, around the table.



Reale CM | 286 | 209, 210



Reale | 290



Tweed | 292 | 228, 230



Quaderna Tavolo | 296 | 17, 352



Quaderna Scrivania | 298



Quaderna Consolle | 300 | 336, 341



Elica | 302 | 225



Blanco | 306



Orione | 308



Fenice | 310



Marcuso | 312



Poker | 314



Santiago | 316 | 264



Cavour CM | 318 | 390, 392



Leonardo | 322



Tucano | 326 | 112



Calamo | 328 | 353



Comacina | 330

Reale CM

Omaggio
Carlo Mollino
1948

leggerezza e precisione in un gioco d'incastri



Lightness and precision in playful interlocks



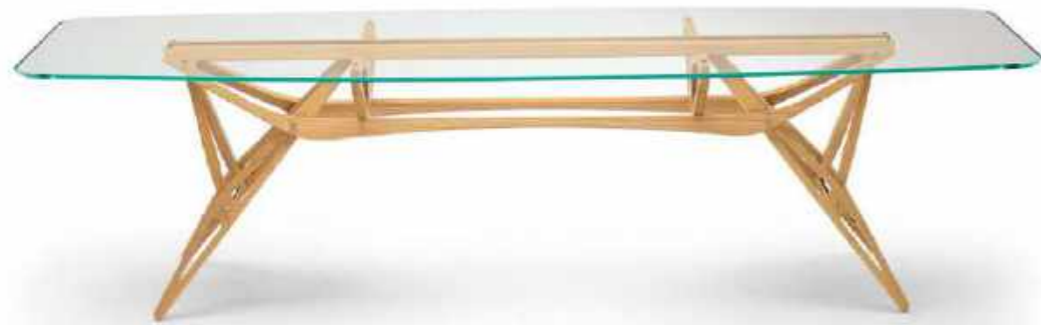

Reale CM | piano cristallo extra chiaro, struttura rovere naturale / *extra clear plate glass top, natural oak frame*
piano cristallo extra chiaro, struttura noce Canaletto / *extra clear plate glass top, Canaletto walnut frame*
piano cristallo fumé, struttura rovere tinto nero / *smoky grey plate glass top, black varnished oak frame*

Reale

Omaggio
Carlo Mollino
1948



Tweed

Design
Garcia Cumini
2017



Gracefully irregular

Dolcemente irregolare





Quaderna Tavolo

Design
Superstudio
1970

P: Medaglia d'Oro Mostra Internazionale M.I.A. 1971.

C: Israel Museum, Jerusalem; Museum für Angewandte Kunst, Köln; Kunstgewerbemuseum, Berlin; Kunstmuseum, Düsseldorf; Fondazione

Triennale Design Museum, Milano; Vitra Design Museum, Weil am Rhein; Musée National d'Art Moderne, Paris.

Perfezione a quadretti

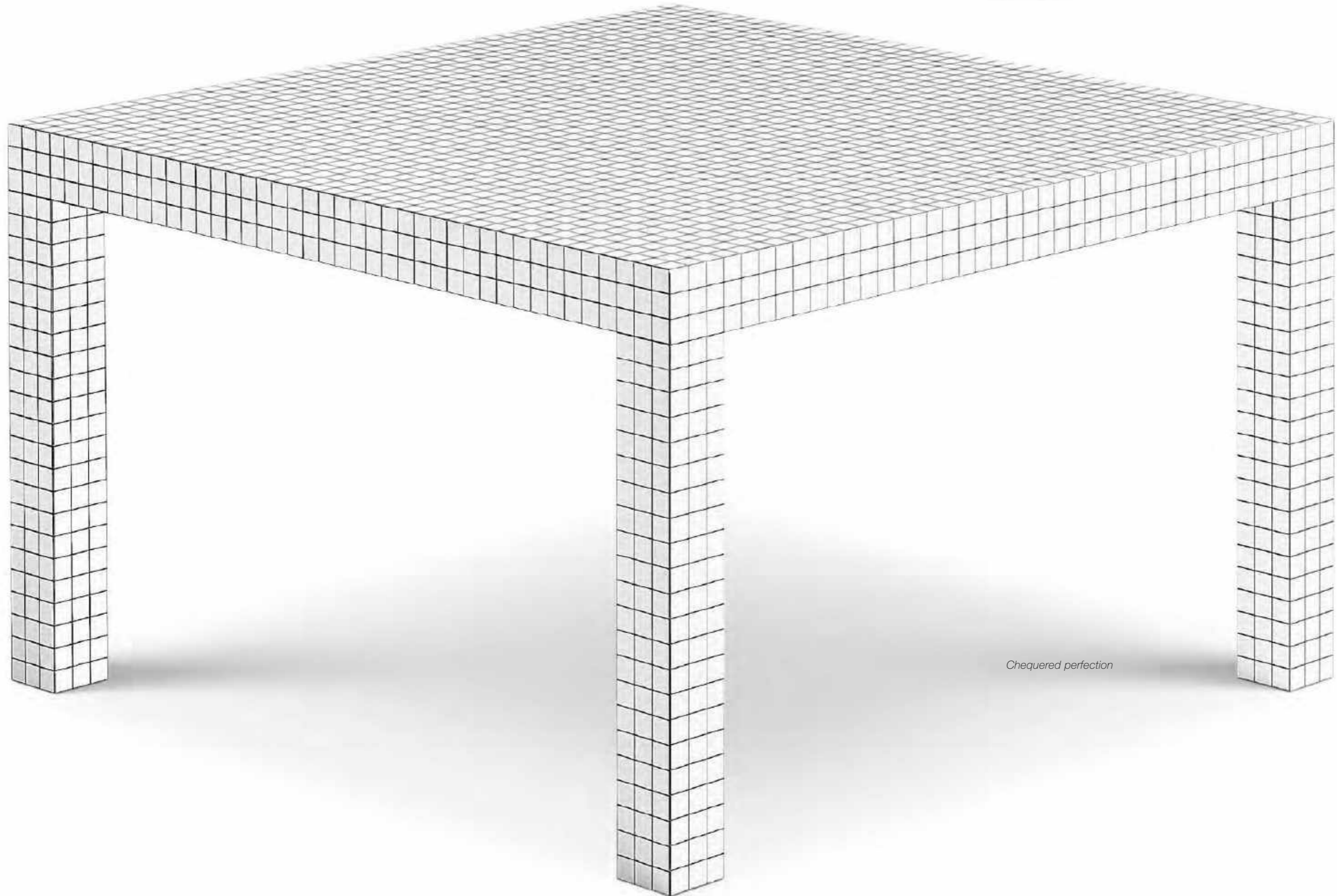

Chequered perfection



I Settanta sono stati anni di transizione e ripensamento, ma anche di utopie visionarie con cui si sono rivoluzionati parametri, pensieri, stili e prospettive. Ideata dal Superstudio di Firenze (fondato da Adolfo Natalini e Cristiano Toraldo di Francia nel '66), Quaderna è nata proprio nel 1970, gli anni del "radical design", un movimento molto attivo nell'area fiorentina che contestava in modo aperto non solo lo stato del design, ma tutto il contesto sociale in cui i progettisti operavano. Una critica esplicita al rigido e dogmatico funzionalismo dell'accademia, contro cui si proponeva una visione liberatoria della vita e del progetto. Nel '69 Superstudio stava lavorando agli "Istogrammi": oggetti costruiti sulla base di un reticolo spaziale a maglia ortogonale, adattabile a diverse scale, dal design all'urbanistica da cui nasce il celebre "Monumento continuo". Una sorta di "Paesaggio artificiale" estensibile a piacere, neutro e forte al tempo stesso che, come una grande rete, "connette" tutto. Superstudio pensa dapprima a un unico piano quadrettato che diventa tavolo o spazio per dormire, ma anche sedia, letto, panca, armadio, sgabello. Nasce una famiglia di mobili unica e irripetibile, fortemente iconica, basata su forme geometriche regolari rivestite di laminato bianco quadrettato creato appositamente da Abet Print, su disegno di Superstudio che venne chiamato Misura, caratterizzata da forme molto rigorose, semplici e perfette.

The 1970's were years of transition and reflection, but also visionary utopias in which parameters, ways of thinking, styles and perspectives were revolutionized. Envisioned by the Superstudio di Firenze (founded by Adolfo Natalini and Cristiano Toraldo di Francia in 1966), Quaderna was born in 1970, the years of "radical design", a movement which was very active in the Florentine scene and openly (and not only) challenged the state of design, as well as the social context in which designers operated. Theirs was an explicit criticism of the rigid and dogmatic functionalism of the academy, whereas they proposed a liberating vision of life and design. In 1969, Superstudio was working on the "Istogrammi": objects constructed according to a orthogonal grid which could be adapted to different scales, from design to urban planning, and led to the creation of the celebrated "Monumento Continuo" – a sort of "Artificial landscape" which could be extended at will, neutral yet strong, like a large net that "connects" everything.

From the start, Superstudio envisions a single chequered shelf that could become a table or sleeping space, but also a chair, bed, bench, armoire, stool. Thus, a family of unique and unrepeatably family of objects was born – decidedly iconic and based upon regular geometric shapes covered with chequered white laminate, made especially by Abet Print, according to the Superstudio design. Called Misura (Measure), it was characterized by forms that were rigorous, simple and perfect.

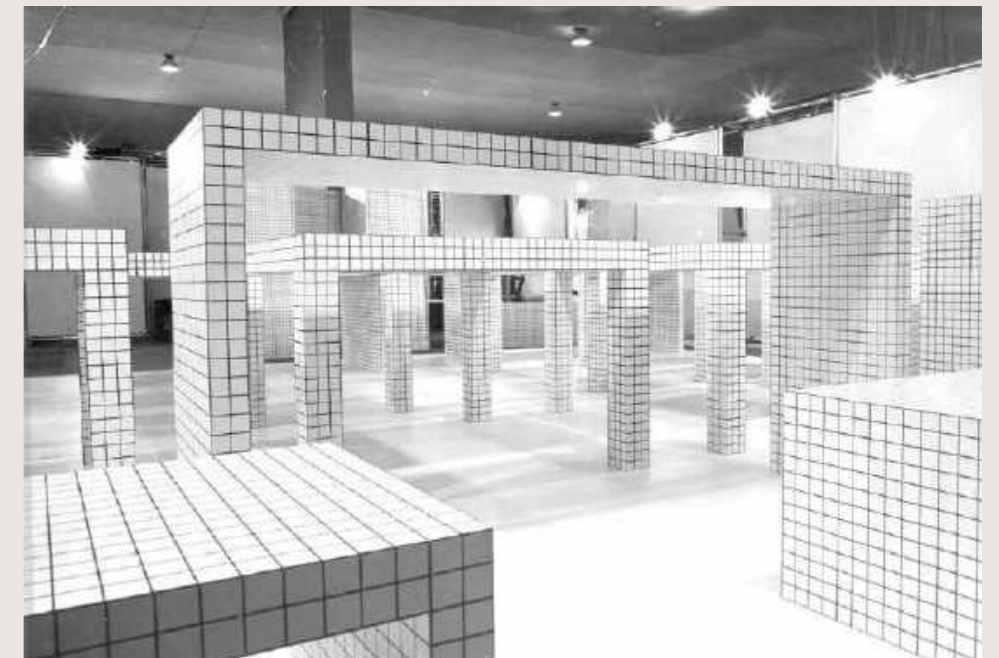

Quaderna Console

Design
Superstudio
1970

P: Medaglia d'Oro Mostra
Internazionale M.I.A. 1971.

C: Israel Museum, Jerusalem;
Museum für Angewandte Kunst,
Köln; Kunstgewerbemuseum,
Berlin; Kunstmuseum,
Düsseldorf; Denver Art Museum;

Fondazione Triennale Design
Museum, Milano; Musée
National d'Art Moderne, Paris;
The Museum of Modern Art,
New York.

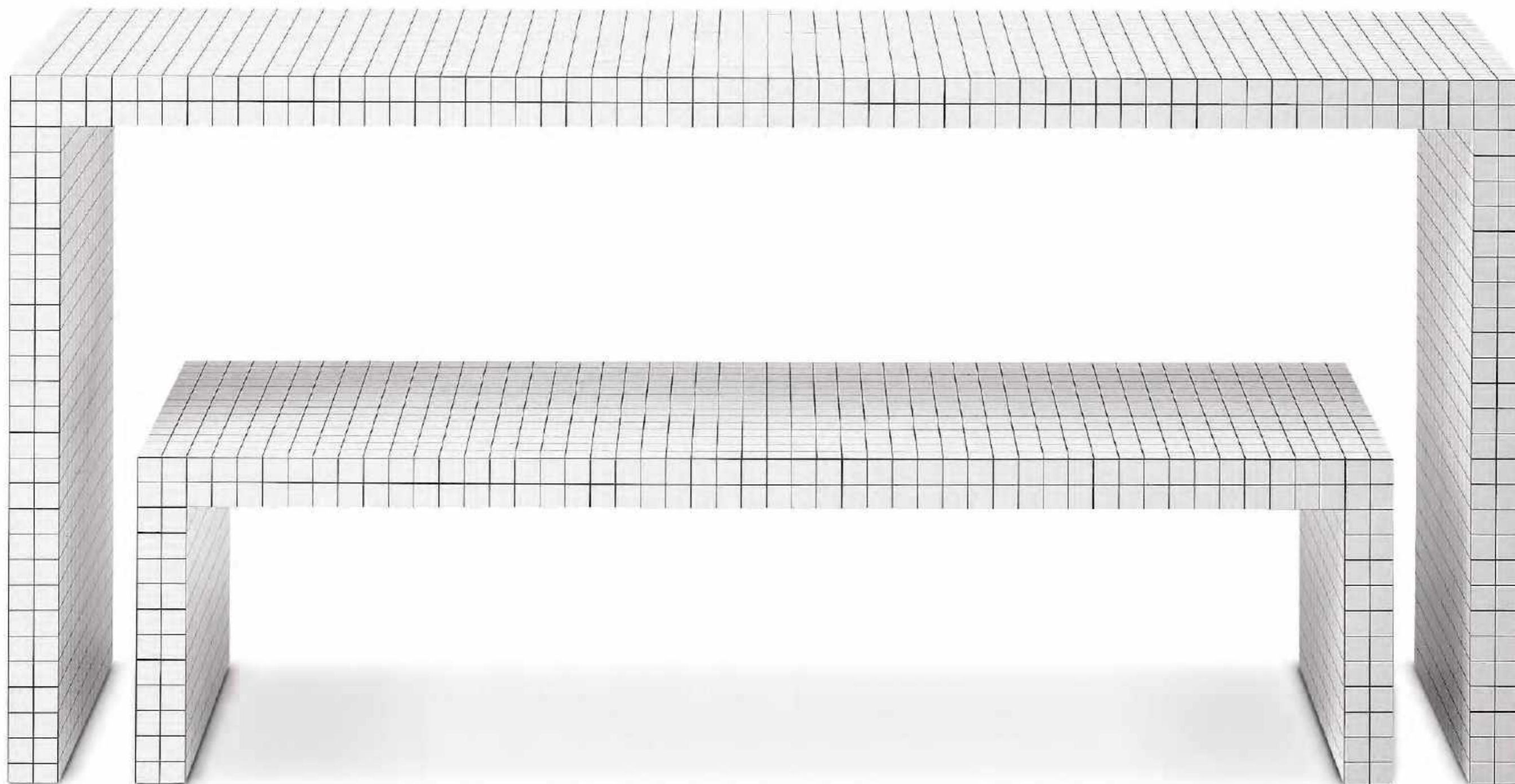

Elica

Design
Prospero Rasulo
2009-2010



Eleganti *torsioni*

Elegant twists



Elica | piano cristallo, basamento Cristalplant® / plate glass top, Cristalplant® base
piano marmo bianco di Carrara, basamento Cristalplant® / white Carrara marble top, Cristalplant® base
piano cristallo fumé, basamento nero / smoky grey plate glass top, black base



Blanco

Design
Jacopo Zibardi
2010



Archetipo senza tempo

Timeless archetype

Orione

Design
Roberto Barbieri
1996

Una *costellazione* di equilibri



A constellation of balances



Fenice

Design
Piero Bottoni
1936

Scoltoraleo e razionale

Sculptural and rational



Grazie ai disegni originali conservati presso il Politecnico di Milano e messi a disposizione dall'Archivio Bottoni, nel 2016 Zanotta riedita il tavolo Fenice con un materiale innovativo (Polimex®). È il primo tavolo moderno a gamba centrale, disegnato nel 1936, vent'anni prima dell'apparizione di tavoli con un supporto simile nei cataloghi di arredamento. Piero Bottoni, uno dei più originali maestri dell'architettura italiana, fece costruire la prima versione di questo tavolo in cemento armato gettato in opera, saldamente ancorato al pavimento della sala da pranzo di Villa Muggia a Imola. Benché la villa sia stata bombardata durante la Seconda guerra mondiale e sia oggi in rovina, il tavolo, vero cuore della casa, è ancora al suo posto, a testimoniare come certe opere di avanguardia siano capaci di sfidare il tempo.

Thanks to the original plans archived at Milan Polytechnic which were made available by the Bottoni Archive, in 2016 Zanotta created a new edition of the Fenice table, using an innovative material (Polimex®). Designed in 1936, this is the first modern table with a central leg, twenty years before tables with this kind of support started to appear in furniture catalogues. Piero Bottoni, one of the original masters of Italian architecture, had the first version of this table built out of cast in place reinforced concrete, solidly anchored to the dining room floor of Villa Muggia, in Imola. Although the villa was bombed during World War II and is now in ruins, the table, the true heart of the house, is still in place, a testament to the fact that some avant-garde works are able to defy time.



Marcuso

Design
Marco Zanuso
1969

P: Selezione Compasso d'Oro
1979; Premio BIO 9 Ljubljana
1981.

C: Fondazione Triennale Design
Museum, Milano; Design
Museum, Gent.



Innovativo nella sua *costruzione*

Innovative construction

Il tavolo Marcuso è nato nel 1969 come risultato di una ricerca sorprendente ed efficace nelle applicazioni della tecnologia industriale. Si trattava di impiegare per la prima volta nel campo dell'arredamento una tecnica avanzata, appena nata dalla sperimentazione dell'industria automobilistica. La sintesi è l'accoppiamento perfetto tra due materiali durevoli ed eleganti, il cristallo e l'acciaio inox. L'idea nacque in modo del tutto casuale dall'osservazione attenta e curiosa di un industriale aperto alle sfide, Aurelio Zanotta, il quale notò il sistema elementare e funzionale che veniva impiegato nei deflettori delle automobili: semplici nottolini in acciaio incollati al cristallo. Decise di applicare il sistema a uno dei suoi prodotti, nella fattispecie a un tavolo, affidando il compito al più tecnologico degli architetti-designer di quegli anni: Marco Zanuso. Per dare forma a quest'intuizione serviva un progettista dalle profonde conoscenze tecniche e con una visione sintetica del disegno.

The Marcuso table was created in 1969 as the result of surprising and efficacious research in the application of industrial technology. It dealt with introducing an advanced technique to the furniture field for the first time, one which had just been born through experimentation in the automotive industry. The synthesis involved the perfect pairing between two durable and elegant materials, glass and stainless steel. The idea came about spontaneously, through the careful and curious observations of an industrialist who was open to challenges, Aurelio Zanotta. He noticed the elementary and functional system utilized for automobile air defectors: simple steel pawls which were glued to the window panes. He decided to apply the system to one of his products, a table in particular, entrusting the task to the most technological of the architect-designers of those years: Marco Zanuso – a designer with thorough technical knowledge and a synthetic vision of design was required to allow this intuition to take shape.



Poker

Design
Joe Colombo
1968

P: Premio BIO 5 Ljubljana 1973.

C: The Museum of Modern Art, New York; Musée d'Art Moderne, Villeneuve d' Ascq; Museo del Design 1880-1980, Milano; Vitra Design Museum, Weil am Rhein.

Let's play



Joe Colombo, ovvero di vizi e di virtù. I vizi di chi ha messo il proprio talento al servizio di Bacco, tabacco e Venere, progettando bicchieri per bere whisky, pipe per fumare e letti alcova per amare (isolandosi dal mondo intorno). Ma anche virtù, di chi aveva imparato a fare il designer perseguendo gli ideali legati alla produzione industriale, attraverso i quali mostrare lo spirito anche tecnologico del proprio tempo: e in Poker, rilettura contemporanea del tavolo da gioco, i piani sono interamente di laminato plastico stratificato, impiegato forse per la prima volta con funzione strutturale. "Amava i nuovi materiali che gli consentivano di esprimere in pieno la sua capacità di disegnare una forma", e "aveva una forte attenzione al dettaglio funzionale, e in questo senso, procedeva con una serie fitta di analisi e di invenzioni" (Gianni Colombo): come quella dei pianetti rotanti che inglobano altrettanti posacenere estraibili, per tornare ai vizi di cui sopra.

Joe Colombo, also known as, of vices or virtues. The vices of a man who put his talents to the test on behalf of Bacchus, tobacco and Venus, designing glasses for drinking whiskey, pipes for smoking, and alcove beds for loving (while isolating oneself from the rest of the world). But also, virtues, of someone who had learned to become a designer by following ideals linked to industrial production, a means to showcase the spirit and technological edge of his time. In Poker, a contemporary revision of a card table, the tops are covered entirely with stratified plastic laminate, where it was perhaps used for the first time for structural purposes. "He loved new materials which allowed him to fully express his ability to design a form", and "he was strongly oriented towards functional details, and therefore proceeded with a series of extensive analyses and inventions" (Gianni Colombo): such as the swivelling ledges that incorporate detachable ashtrays, returning to the vices mentioned above.

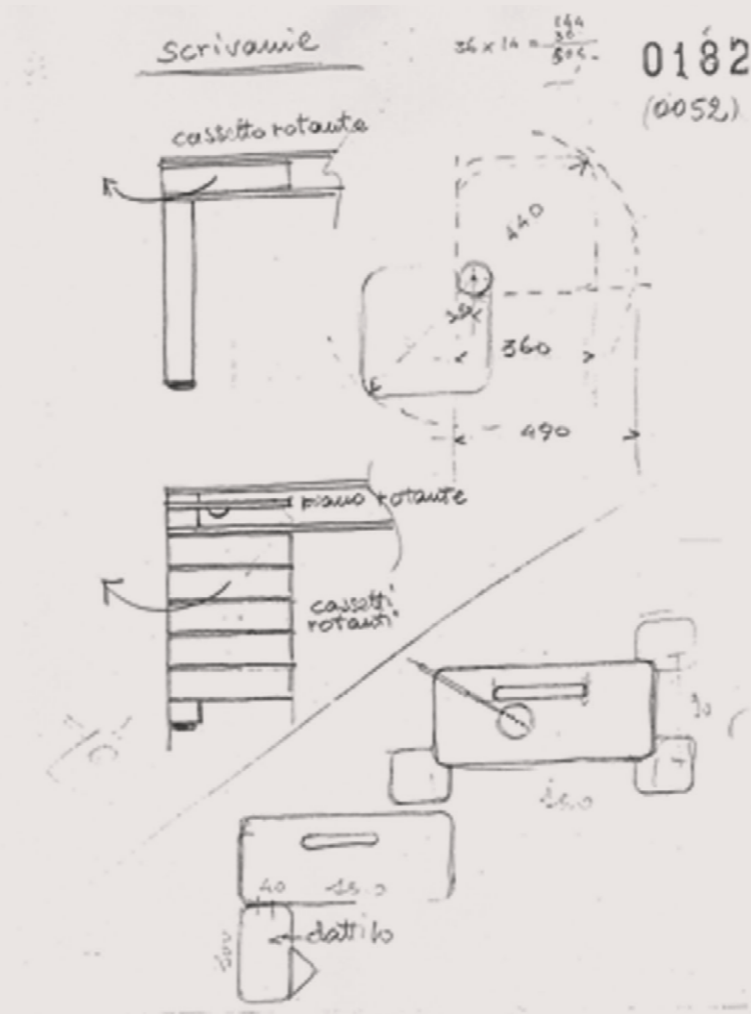

Santiago

Design
Frank Rettenbacher
2015



La *leggerezza* del disegno,
la *solidità* del massello



Lightness of design, in solid wood

Santiago | piano e gambe rovere tinto bianco / white varnished oak top and legs
piano e gambe noce Canaletto / Canaletto walnut top and legs
piano e gambe rovere naturale / natural oak top and legs

Massima forza e minimo peso: *elegantia*

Maximum strength and minimum weight: elegantia

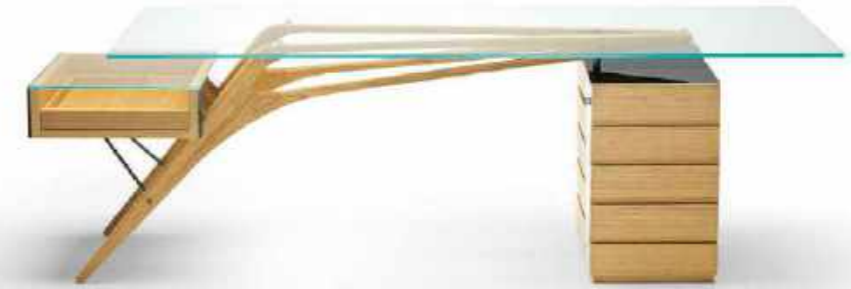



Leonardo

Design
Achille Castiglioni
1969

C: Museo del Design 1880-
1980, Milano; Thessaloniki
Design Museum, Saloniki;
Victoria & Albert Museum,
London.

Sempre all'altezza

Always perfectly calibrated





Tucano

Design
Monica Förster
2020



Lo spazio di un pensiero *sottile*



The space of rarefied thought

Calamo

Design
Gabriele Rosa
2013

Leggero e versatile,
capace di *custodire* un segreto

Light and versatile, good at keeping secrets



Comacina

Design
Piero Bottoni
1930

Una linea continua

A continuous line





**: LA PRATICA
SILENZIOSA
DI SCRIVERE
IL TUONO.**

: the silent practice of writing thunder.

Domenico Romeo



**: la continua pratica nutre lo spirito.
L'ossessiva ripetizione del segno genera
ricerca e fissa il rito nell'eterno ritorno
al principio.**

*: continuous practice nourishes the spirit. The obsessive repetition
of a making a mark generates research and secures the ritual,
in an eternal return to the start.*









**: è di notte che la stanza
diventa un tempio, il corpo
medita raggiungendo altre
sfere. Solo allora si instaura
un dialogo interiore
che plasma il concetto
e si trasforma in scintilla
creativa.**

*: nighttime is when the room becomes a temple, the body meditates
to reach other spheres. Only then is an internal dialogue established
to give shape to a concept, transforming it into a creative spark.*



: TANTI CAPITOLI DI UNA VITA DIVENTANO UN UNICO MONDO.

*: the many chapters of a life become
a single world.*

Sergio Venuti



Ricordi | letto, tessuto Tito 31854, struttura rovere tinto nero / bed, fabric Tito 31854, black painted oak frame

Taschino | comodino, piano cuoio 0814, struttura nera / night table, cowhide 0814 top, black frame

346 **Moretta** | poltroncina, tessuto Telastrong 20001 / armchair, fabric Telastrong 20001







Quaderna | tavolo / table

Celestina | sedia, cuoio 0704, struttura bianca / chair, cowhide 0704, white frame

352 Calamo | scrittoio, piano cuoio 0807, struttura nera / desk, cowhide 0807 top, black frame



**: la casa,
sponda sicura.
La pittura,
misura di me
e del mondo.
La moda,
l'incontro
con l'altro.**

*: the home, a safe harbour.
Painting, a measure of myself and the world.
Fashion, encountering one another.*

Secondo voi possiamo lasciare al caso il luogo in cui trascorriamo quasi un terzo della nostra vita? La comodità viene prima di tutto. Dalla morbidezza del materasso o degli elementi rivestiti alla funzionalità dei contenitori. Sempre curati nel minimo dettaglio. Progettare il letto per noi significa dare forma al sonno, alla passione, al relax. Al sogno.

Do you really think we could leave the place where we spend nearly one third of our lives to chance? Comfort comes first. From the softness of the mattress or upholstered elements to the functionality of the containers. All are curated down to the smallest detail. To us, designing a bed means giving a shape to slumbers, passion, leisure. To dreaming.



Ricordi | 358 | 344, 346



Talamo | 362 | 337, 339



Nyx | 366



Milano | 370



Grangala | 372



Greg | 374



Milleunanotte | 375



Box | 376



Greta | 378



Florin | 379

Ricordi

Design
Spalvieri & Del Ciotto
2020



Due grandi cuscini,
un semplice gesto

Two large cushions, one simple gesture



Talamo

Design
Damian Williamson
2011

Una forma *decisa*, vestita con *gentilezza*



Undaunted form, superbly attired



Nyx

Design
Emaf Progetti
2010



Comodo come un divano,

Comfortable like a sofa, essential like a frame

essenziale come una cornice



Milano

Design
De Pas, D'Urbino, Lomazzi
1983

Rigoroso e *regolabile* in altezza



Height adjustable rigour



Grangala

Design
Gabriele Rosa
2018

Una grande testata che *accoglie* e che contiene



A prominent headrest to support and contain



Greg

Design
Emaf Progetti
2002

Be bold!

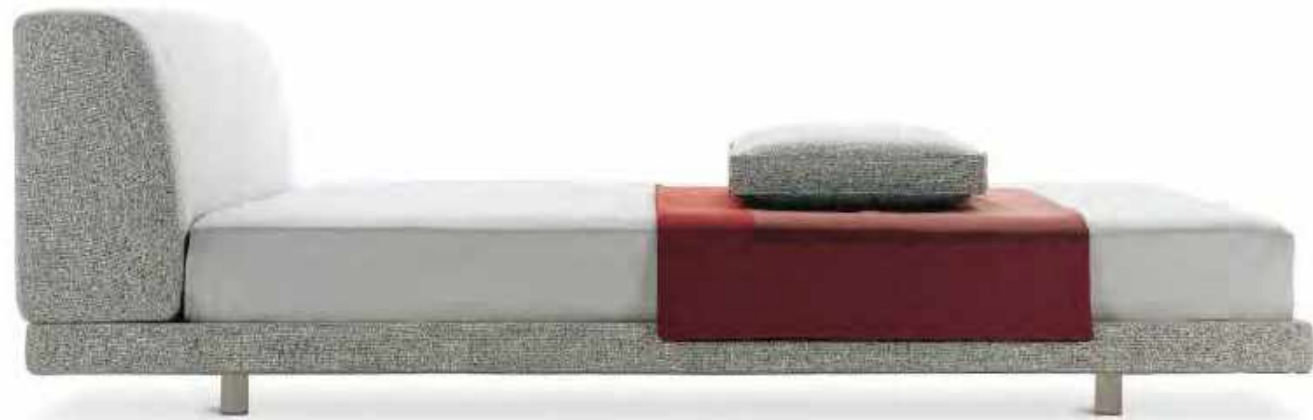

Milleunanotte

Design
Emaf Progetti
2006

La stanza in *in una stanza*



The room within a room

Box

Design
Emaf Progetti
2005

La *quarta dimensione* del letto



A bed spanning four dimensions



Greta

Design
Roberto Lazzeroni
2018



Custode della notte

Guardian of the night



Florin

Design
Roberto Lazzeroni
2018



New tradition



**: REGOLA N.1
VIVI SEMPRE LE TUE ORIGINI,
VIVI OGGI IL FUTURO.**

*: rule n.1 always live your origins,
live the future today.*

Malcolm Cosenza





Sacco | poltrona, tessuto Vip 27547 / easy chair, fabric Vip 27547
Quaderna | tavolino / small table



**: regola n.2
vivi sempre
il futuro,
vivi oggi
le tue origini.**

*: rule n.2 always live the future,
live your origins today.*

: IT'S A JUNGLE IN THERE.

Enrico Forestieri

: in inverno, è bello attardarsi a leggere quando il sole basso si riflette sul parquet lucido e inonda la sala. In queste settimane di caldo torrido, si ha un sollievo istantaneo, benché illusorio, appena si sentono stormire le foglie del peperoncino e della papaya. A notte fonda, la monstera proietta ombre cinesi sulle pareti.

: in the winter, it is wonderful to linger and read when the low sun reflects on the shiny wooden floor, flooding the room. In these weeks of scorching heat, one feels instant relief, if briefly, once the leaves of the hot pepper and papaya start to rustle. In the middle of the night, the monstera casts Chinese shadows on the wall.







Cavour CM | scrivania, piano cristallo extra chiaro, struttura rovere naturale /
writing desk, extra-clear plate glass top, natural oak frame
Albero | portavasi verde / green flowerpot-stand

: quel che più mi piace è la reattività alle condizioni di luce, temperatura e umidità esterne. Un paesaggio sensibile ai cambi di luce e di stagione, in cui cerco e scopro ogni giorno le atmosfere che più si accordano al mio mutevole stato d'animo. Una giungla ospitale.

: what I like most of all is the reactivity to the external conditions: lighting, temperatures and humidity levels. It is a setting which is sensitive to the changes of light and the seasons, where each day, I seek and discover the atmospheres that harmonize best with my variable state of mind. A hospitable jungle.



Crediamo in una idea di casa basata su oggetti carichi di qualità, di generosità. E di poesia. Oggetti che diventano compagni di vita. Oggetti che parlano di chi, quella casa, la abita e la vive. Oggetti diversi tra loro, ma capaci di costruire relazioni. Oggetti a volte inaspettati, a volte divertenti, a volte essenziali. Un caleidoscopio di materiali, di forme, di funzioni talvolta mai viste prima, con sempre, alla base, la qualità di pensiero prima e di esecuzione dopo. Oggetti con un'anima. Oggetti? Emozioni.

We believe in an idea based upon objects full of character, generosity. And poetry. Objects that become lifetime partners. Objects that say something about who lives and inhabits a home. Objects that differ from one another, but capable of establishing relationships. Objects that are sometimes unexpected, amusing, essential. A kaleidoscope of materials, forms, and functions that might never have been seen before, but are always initially based on an excellent idea, then exquisitely executed. Objects with a soul. Objects? Emotions.



Sciangai | 398 | 30



Mezzadro | 402 | 67, 210, 324



Sella | 404 | 32, 79, 83



Allunaggio | 406



Follia | 408 | 213, 217



Primate | 410



Joy | 412 | 97, 101



Albero | 416 | 392



Museo | 418



Aster | 420 | 100, 103, 211



Servomanto | 422



Servietto
Servonotte | 424, 425 | 371



Servopluvio
Servofumo | 426, 427



Servobandiera | 428



Servento | 430



Servostop | 431



Giotto | 432



Chichibio | 433



Milo CM | 434



Pablo | 436



Raperonzolo | 437



Veryround | 438

Sciangai

Design
De Pas, D'Urbino, Lomazzi
1973

P: Selezione FIAT "Italian Design" 1978; Premio Compasso d'Oro 1979; Premio BIO 9 Ljubljana 1981.

C: Israel Museum, Jerusalem; Kunstgewerbemuseum, Berlin; Fondazione Triennale Design Museum, Milano; The Museum of Modern Art, New York; Fond National d'Art Contemporain,

Puteaux ; LAB Museo del Design, Fondazione Anna Querci, Calenzano; Thessaloniki Design Museum, Saloniki; Design Museum, Gent.



chiuso, aperto, regolabile

Open Closed Adjustable



Un appendiabiti dal funzionamento altamente sofisticato ma al contempo immediato che, come suggerisce il suo nome prende ispirazione dal gioco da tavolo cinese, con tanti bastoncini di legno da far cadere su un piano, dopo averli tenuti insieme con la mano, al centro. In Sciangai, ogni elemento costituisce un appoggio a terra e, al tempo stesso, un sostegno per cappotti e cappelli nella sua estremità superiore, modellata appositamente per reggere ogni capo. Gli otto listelli in legno massello che lo compongono sono connessi da un giunto poco al di sopra del centro e creano, da aperti, una circonferenza regolabile a piacere e in base allo spazio a disposizione, ottenendo un appendiabiti più o meno ingombrante. Il trio più dirompente del design degli anni 70, De Pas, D'Urbino e Lomazzi, ha inaugurato un approccio all'abitare fresco destinato a rivoluzionare il modo di intendere l'abitare borghese contemporaneo. Elegante e anticonformista, Sciangai vinse il Compasso d'Oro nel 1979.

A garment hanger that functions in a highly sophisticated, yet immediate manner, inspired by the Chinese table game that involves holding numerous wooden sticks and then dropping them onto a surface. In Sciangai, each element is both a floor support and a resting place for coats and hats at the other end, designed specifically to hold garments of all kinds. The eight poles made of solid wood are connected by a joint just above the centre. When open, they create a circumference that can be adjusted according to how much space is available, thus allowing the garment hanger to occupy more or less space. The most disruptive design trio of the 1970's, De Pas, D'Urbino and Lomazzi inaugurated a fresh approach to living, destined to revolutionizing the contemporary bourgeois way of life. Elegant and non-conformist, Sciangai was awarded the Compasso d'Oro in 1979.

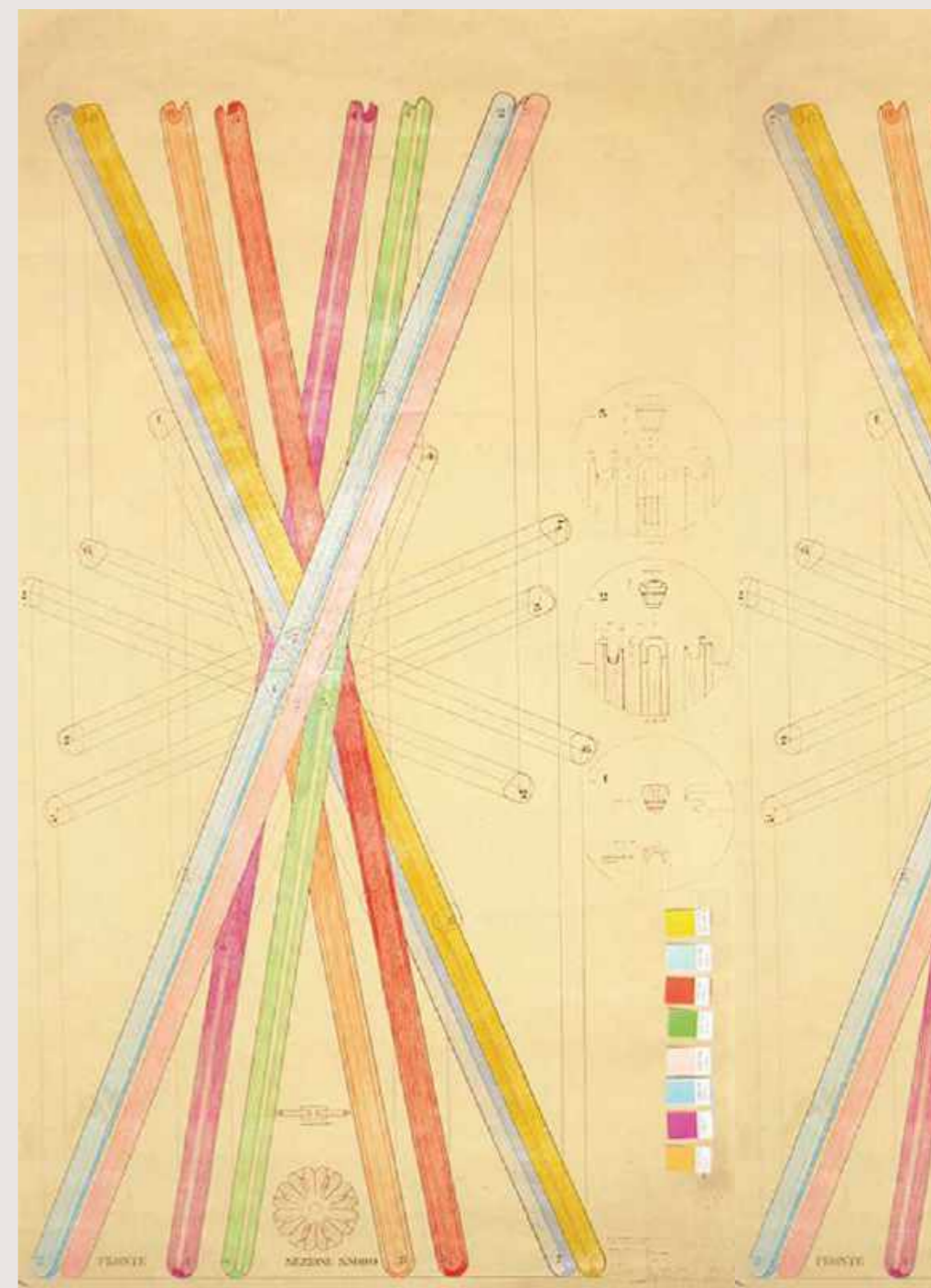

Mezzadro

Design

Achille e Pier Giacomo Castiglioni
1957

C: The Museum of Modern Art, New York; Israel Museum, Jerusalem; Uměleckoprůmyslové Muzeum, Praha; Die Neue Sammlung, München; Kunstgewerbemuseum, Berlin e Zürich; Museo del Design 1880-1980, Milano; Kunstmuseum, Düsseldorf; Museum für Angewandte Kunst, Köln; Fondazione Triennale

Design Museum, Milano; Vitra Design Museum, Weil am Rhein; Musée National d' Art Moderne, Paris; Thessaloniki Design Museum, Saloniki; Gustav Lübcke Museum, Hamm; Fonds Régional d' Art Contemporain, Dunkerque; Musée des Arts Décoratifs, Paris; Museum für Angewandte Kunst, Wien; The Saint Louis Art Museum; The Montreal

Museum of Fine Arts; Museum für Kunst und Gewerbe, Hamburg; Nordenfeldske Kunstindustrimuseum, Trondheim; Indianapolis Museum of Art; Design Museum, Gent; Musée des Arts Décoratifs, Bordeaux; CID au Musée du Grand Hornu, Hornu; M.A.X. Museo, Chiasso; Cooper Hewitt Smithsonian Design Museum, New York.

Un pensiero *libero* disegna
un oggetto *inaspettato*

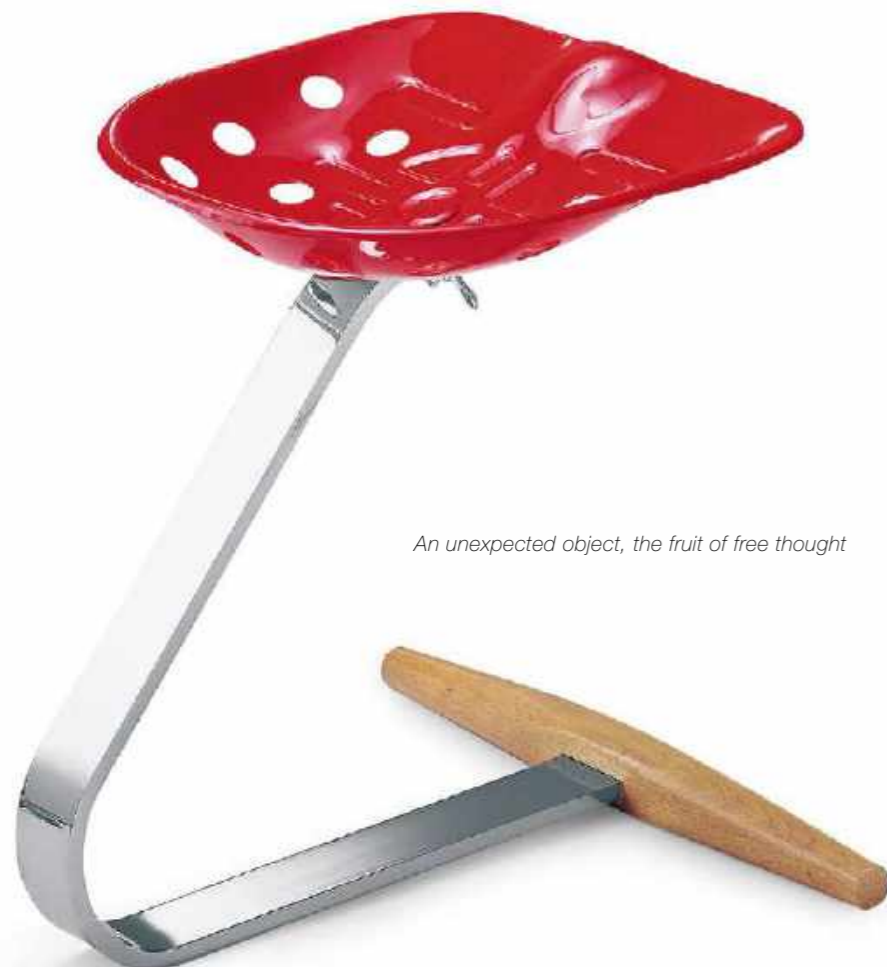

An unexpected object, the fruit of free thought

Il Mezzadro è insieme la più riuscita provocazione formale del design italiano e la negazione stessa di design. È infatti frutto del tipico processo progettuale dei fratelli Castiglioni che, attraverso l'assemblaggio ironico perfettamente funzionante di parti industriali apparentemente scombinare, creano nuove tipologie, nuovi prodotti a loro volta adatti ad un processo di produzione rigorosamente seriale. Il "sedile metallico molleggiato", metaforicamente chiamato appunto Mezzadro, che Achille e Pier Giacomo Castiglioni avevano disegnato nel 1957 (insieme al sedile Sella) per la mostra "Forme e colori nella casa d'oggi" allestita a Villa Olmo di Como, introduce nel design il metodo compositivo del Ready-Made, che utilizza componenti trovati, "già fatti", per essere assemblati in inediti oggetti d'uso. I componenti usati nel Mezzadro sono quattro: un sedile da trattore, un galletto da bicicletta da corsa, una balestra di wagons-lit e un fuso in legno di brigantino Cutty-Sark. Mezzadro è un messaggio forte e chiaro di libertà nella definizione dello spazio domestico.

Mezzadro is both the most successful formal provocation towards Italian design and the refusal of design itself. In fact, it is the fruit of the typical design process of the Castiglioni brothers who, by assembling perfectly functional industrial parts in an ironic and seemingly disorderly way, actually create new typologies, new products that are then adapted to rigorous serial production. The "springy metal seat", metaphorically called Mezzadro (literally a sharecropper), which Achille and Pier Giacomo Castiglioni designed in 1957 (along with the Sella seat) for the exhibition, "Forms and colors in today's home", held in Villa Olmo in Como, introduced the compositional method of Ready-Made to design. In this approach, ready-made components are found and assembled into all-new objects. Four components are used for the Mezzadro: a tractor seat, a racing bike pin, a steel crossbow and a wooden crosspiece from a Cutty-Sark sailboat. Mezzadro is a strong and clear declaration of independence for the definition of domestic space.

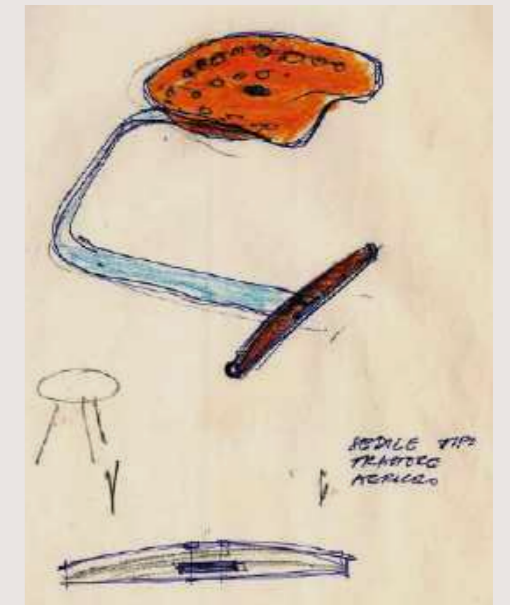
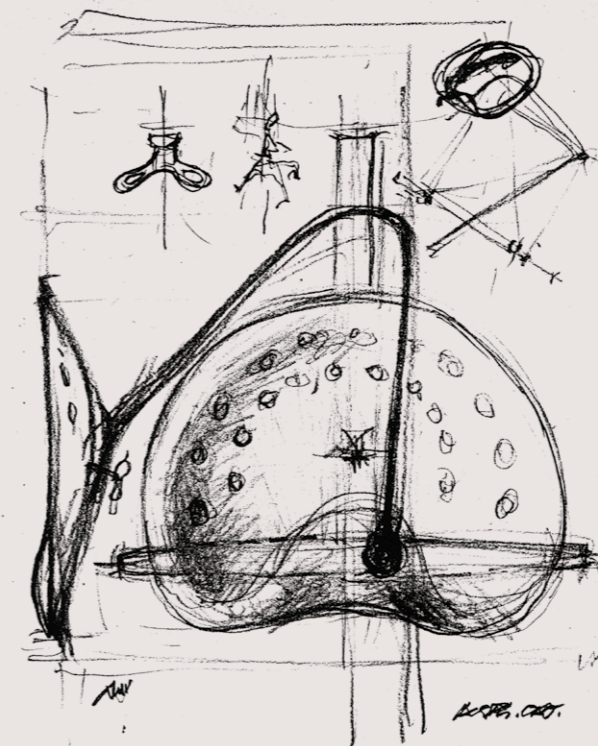

Sella

Design
Achille e Pier Giacomo Castiglioni
1957

C: Israel Museum, Jerusalem; Kunstgewerbemuseum, Berlin; Museum für Angewandte Kunst, Köln; The Design Museum, London; Fondazione Triennale Design Museum, Milano; Vitra Design Museum, Weil am Rhein; Musée National d'Art Moderne,

Paris; Thessaloniki Design Museum, Saloniki; Gustav Lübcke Museum, Hamm; Fonds Régional d'Art Contemporain, Dunkerque; Museum für Kunst und Gewerbe, Hamburg; Lippisches Landesmuseum, Detmold; Nordenfjeldske

Kunsthindustrimuseum, Trondheim; Indianapolis Museum of Art; Musée des Arts Décoratifs, Bordeaux; M.A.X. Museo, Chiasso; The Designmuseum Danmark, Copenhagen.

Equilibrio *dinamico*



Dynamic balance

Una seduta per stare comodi, ma non troppo; seduti, ma non troppo a lungo; indicato in special modo per scoraggiare l'eterno protrarsi di conversazioni telefoniche quando l'apparecchio nelle case era ancora fissato alla parete e lo sgabello offriva appoggio per una breve sosta conversativa. Un gesto tra il dadaista e il ready-made, e un colore omaggio alla maglia rosa che proprio nel 1957, quando i fratelli Castiglioni progettarono la seduta, correva la quarantesima edizione del Giro d'Italia. Al di là della dichiarata allusione al mondo ciclistico l'oggetto si ispira al classico sedile del mungitore, quello che si "indossava" allacciandoselo in vita, costituito da un piano molto semplice e con un unico appoggio a terra a dare stabilità.

A seat that is meant to be comfortable, but not overly so; on which to sit, but not for too long – particularly useful for discouraging never ending conversations when the home telephone was still connected to a land line. This stool offered a seating place for a brief moment of conversation. It is a gesture that falls somewhere between Dadaism and ready-made, in a color that pays tribute to the pink shirt that symbolized the 40th edition of the Giro d'Italia, the same year (1957) the Castiglioni brothers designed this seat. Beyond the declared reference to the world of cycling, the object is inspired by the classic seats of cow-milkers, the kind that could be "worn" by tying it around the waist, formed with a simple top resting on top of a single leg.



Allunaggio

Design

Achille e Pier Giacomo Castiglioni
1965

P: Selezione Compasso d' Oro,
1981.

C: Kunstgewerbemuseum,
Zürich; Centro per l'arte
contemporanea Luigi Pecci,
Prato; Taideteollisuusmuseo
Konstindustrimuseet, Helsinki;
Israel Museum, Jerusalem;

Musée National d' Art Moderne,
Paris; Fonds Régional d'Art
Contemporain, Dunkerque;
Musée des Arts Décoratifs,
Paris; Musée des Arts
Décoratifs, Bordeaux.



To the moon and back

Questa seduta per esterni è un omaggio a uno degli eventi più importanti della "conquista dello spazio" (celebrata con lo sbarco sulla luna nel 1969): la ricognizione mediante sonde dell'unico satellite terrestre. Ma i Castiglioni sdrammatizzano la solidità con un oggetto leggero, aereo, che dà spazio all'erba di crescere intorno e minimizza la proiezione dell'ombra sul terreno. Un piccolo passo per l'uomo...

This outdoor seat is a tribute to one of the most important events of humankind "conquering space" (celebrated by the landing on the Moon in 1969): the reconnaissance mission during which the Earth's only satellite was first explored. The Castiglioni brothers, however, make light of solidity with this lightweight, airy object, that gives grass the room to grow around it and minimizes the casting of a shadow on the ground. A small step for mankind....



Folia

Design
Giuseppe Terragni
1934

C: The Museum of Modern Art, New York; Neue Sammlung, München; Kunstgewerbemuseum, Berlin; Museum für Angewandte Kunst, Köln; Vitra Design Museum, Weil am Rhein.



Una *parentesi* nel rigore

Rigour in parentheses



Primate

Design
Achille Castiglioni
1970

C: The Museum of Modern Art, New York; Kunstgewerbemuseum, Zürich; Vitra Design Museum, Weil am Rhein; Musée National d' Art

Moderne, Paris; Fonds Régional d'Art Contemporain, Dunkerque; Fondazione Triennale Design Museum, Milano.

move vecchie abitudini

Novel old habits



Joy

Design
Achille Castiglioni
1989

P: Selezione Compasso d'Oro
1991.

C: Fondazione Triennale Design
Museum, Milano; Fond National
d'Art Contemporain, Paris;
Indianapolis Museum of Art.



giocare con lo spazio



Play with space





A small vertical forest

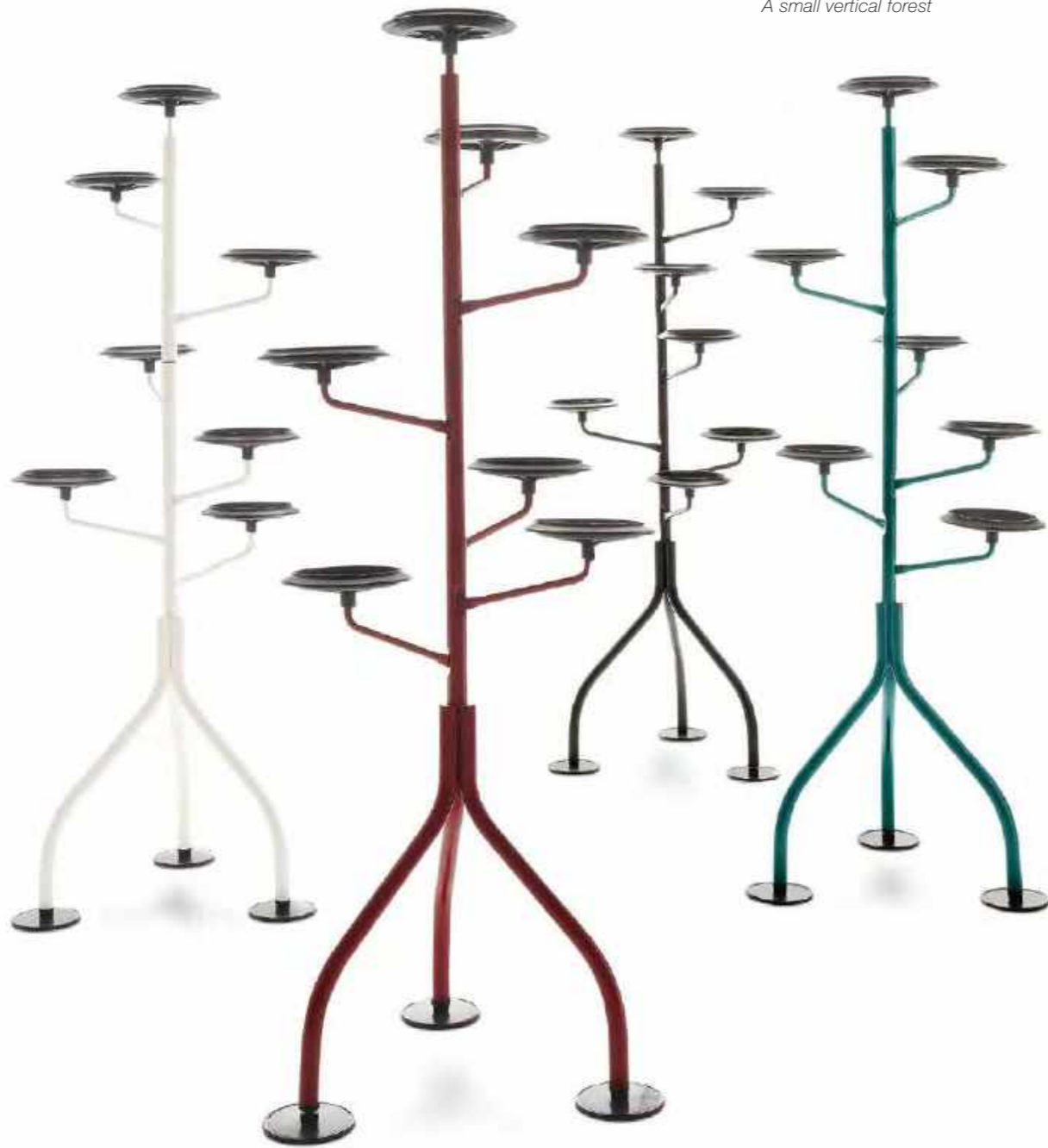

Un piccolo *bosco* verticale

È il 1983 quando Achille Castiglioni immagina una presenza sottile, dinamica nella sua composizione, flessibile nel suo articolato disegno complessivo, destinata ad accogliere le piante da appartamento nei loro rispettivi vasi, sostenuti, come fossero mani premurose, da piattelli circolari disposti ritmicamente lungo l'altezza della struttura. Orizzontalmente ogni elemento è libero di ruotare di 120 gradi, così da organizzare al meglio la disposizione di piante di dimensioni differenti. In questo piccolo "bosco verticale" domestico, è un ottimale incontro con la luce.

It was 1983 when Achille Castiglioni imagined a slender presence, with a dynamic composition, flexible in its comprehensively articulated design. The object was destined to support potted house plants, as if to hold them carefully by hand, with round platforms rhythmically placed along the stand. Each element can be rotated 120 degrees, in order to best accommodate plants of different sizes. In this small domestic vertical forest, the interplay with light is optimal.

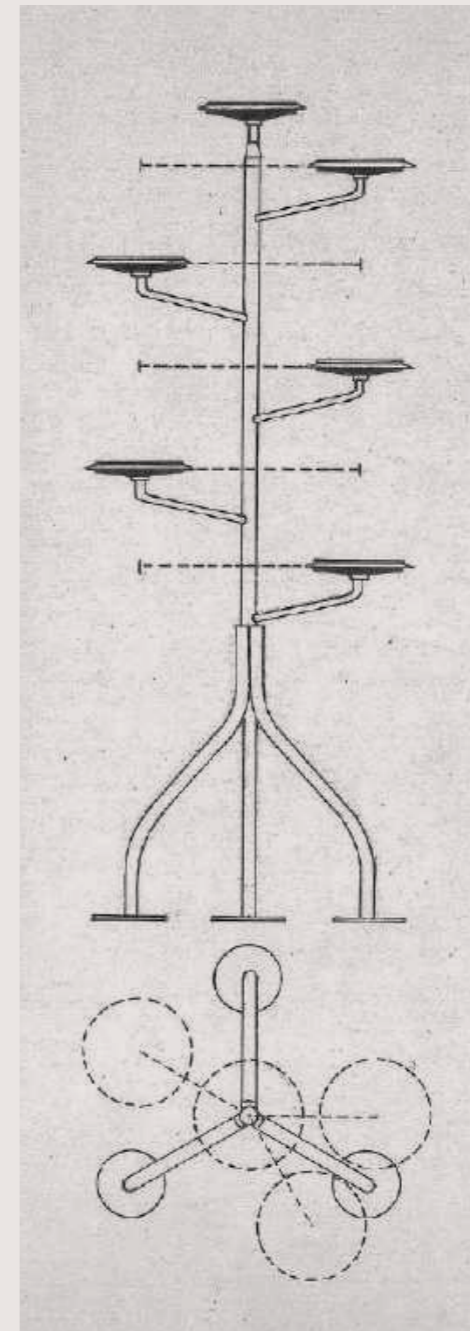

un segno continuo

la forma crea la funzione



*A continuous sign,
form creates function*



Un *nastro* scultoreo



Sculptural ribbons

Aster | 6 ganci acciaio verniciato nero, rosso / 6 hooks, black, red painted steel
4 ganci acciaio verniciato bianco / 4 hooks, white painted steel



Aster | 6 ganci, acciaio verniciato rosso / 6 hooks, red painted steel **Mezzadro** | sgabello / stool

Design

Achille Castiglioni
della serie Servi di Achille
& Pier Giacomo Castiglioni
1985

Piccoli *assistenti* domestici

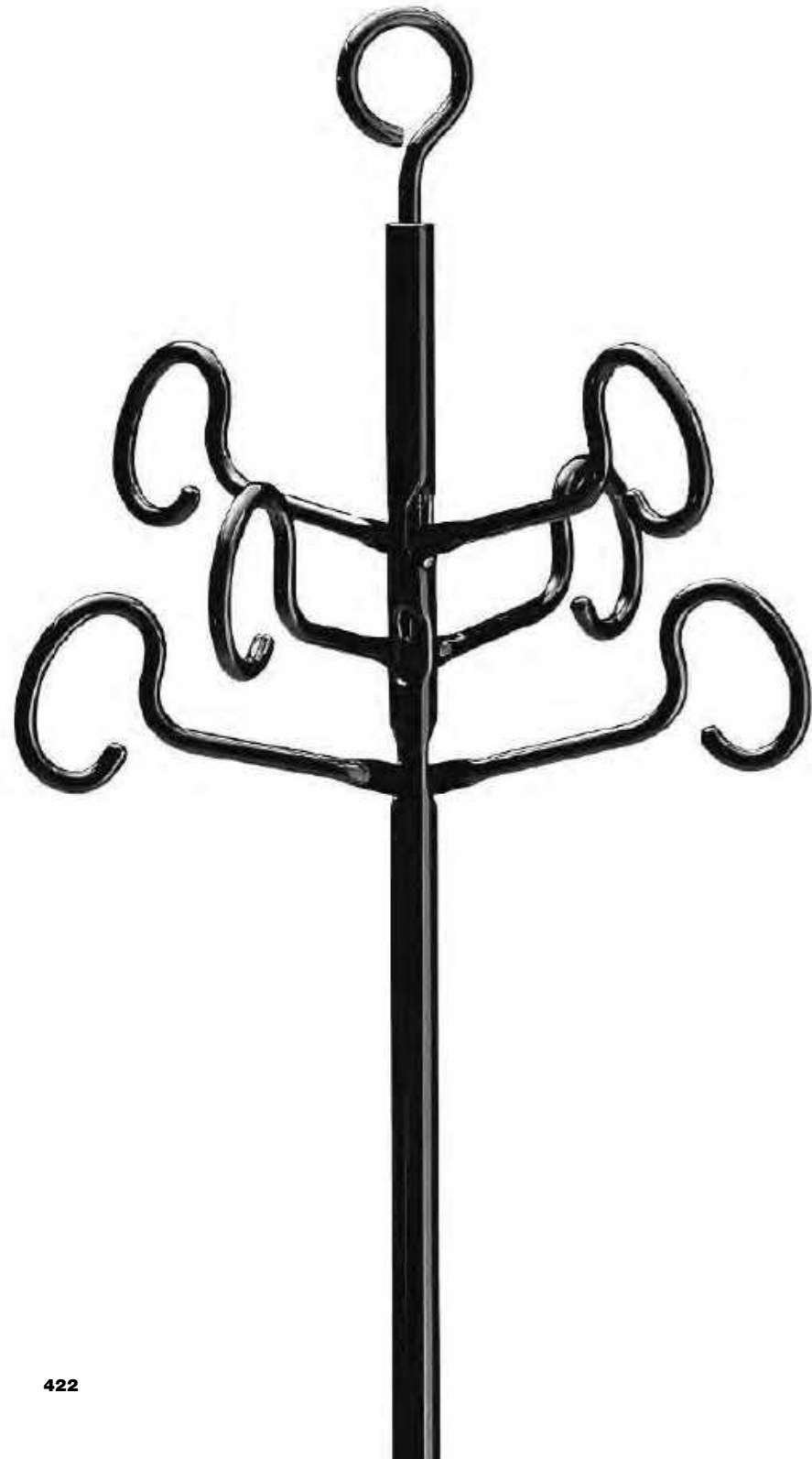

Small domestic helpers

La serie Servi si sviluppò nell'arco di un ventennio a partire dal 1961. I designer milanesi, Achille e Pier Giacomo Castiglioni, la concepirono come una serie funzionale, minimale e resistente; adatta a "servire" gli spazi domestici ma anche quelli pubblici; un sistema componibile, smontabile, modulare. Un'unica base in polipropilene, un'asta d'acciaio alta o bassa che fa da sostegno e alcuni accessori che reggono, portano, contengono, segnalano. I primi a nascere, nel '61, dalla straordinaria abilità compositiva dei fratelli Castiglioni furono i due capostipiti Servofumo e Servopluvio, rispettivamente un posacenere da terra e un portaombrelli essenziale. Li concepirono, come accade spesso ai progettisti che non trovano sul mercato ciò che cercano, per arredare gli spazi del ristorante-birreria Splügen di Milano.

The Servi (servant) range was developed over a twenty-year period, starting in 1961. The Milanese designers, Achille and Pier Giacomo Castiglioni, conceived the series to be functional, minimal and durable; suitable for "serving" both domestic and public spaces; the system can be assembled, disassembled, modulated. It consists of single polyurethane base and a high or low metal pole on which to provide support for several accessories that hold, carry, contain or notify. The first were developed in 1961, when the Castiglioni brothers' extraordinary compositional prowess led to the creation of the two original pieces: Servofumo and Servopluvio, a free-standing ashtray and an essential umbrella holder. They were conceived, as is often the case with designers who cannot find what they seek in the market, to furnish the location of the Splügen beer house/restaurant in Milan.

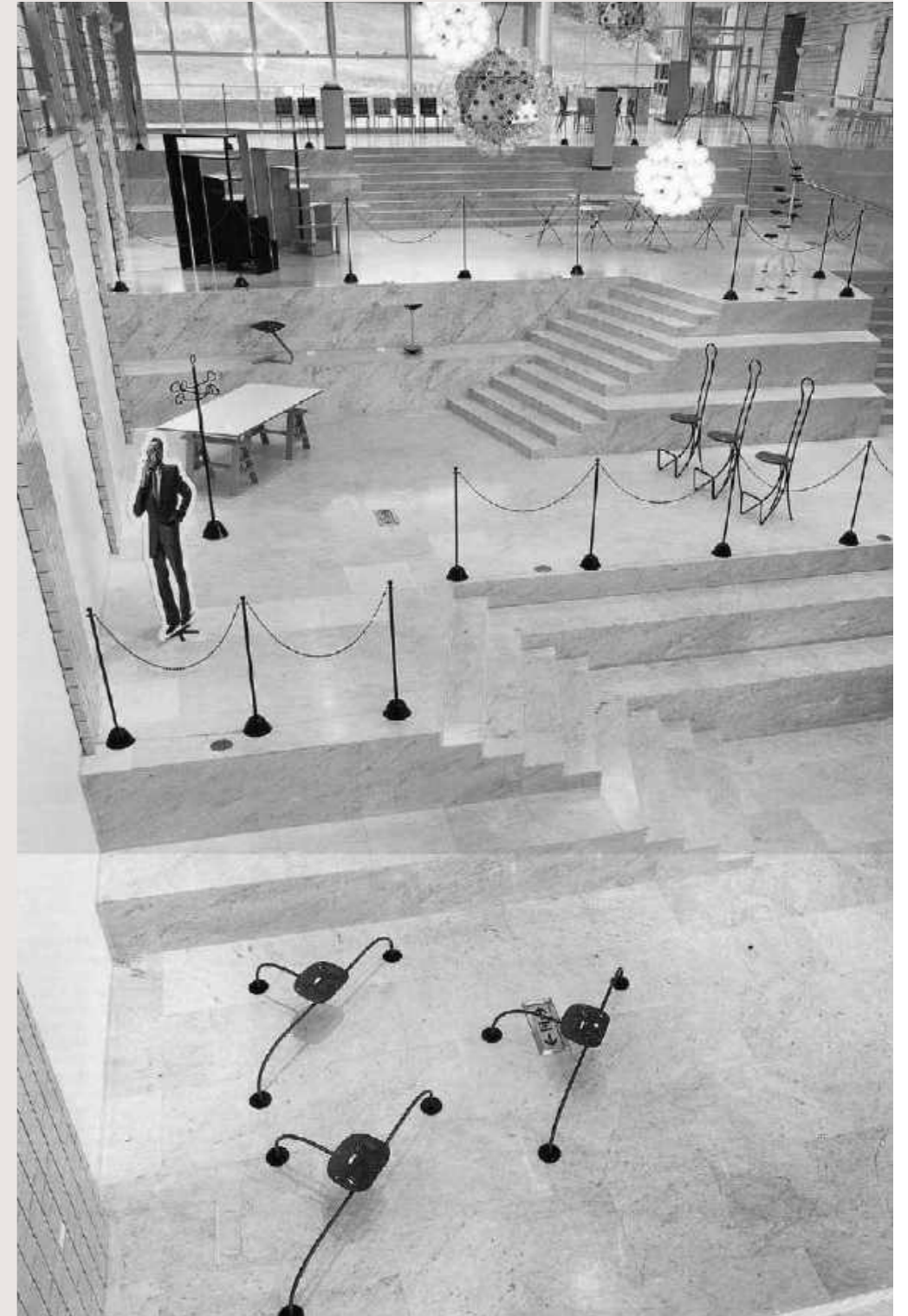

Servietto

Design
Achille Castiglioni
della serie Servi di Achille
& Pier Giacomo Castiglioni
1986

C: Thessaloniki Design
Museum, Saloniki.



Servonotte

Design
Achille Castiglioni
della serie Servi di Achille
& Pier Giacomo Castiglioni
1986

C: Thessaloniki Design
Museum, Saloniki; M.A.X.
Museo, Chiasso.



Servopluvio

Design
Achille e Pier Giacomo Castiglioni
1961

C: M.A.X. Museo, Chiasso.

Servofumo

Design
Achille e Pier Giacomo Castiglioni
1961

C: Thessaloniki Design
Museum, Saloniki; M.A.X.
Museo, Chiasso.



Le forme dell'utile

Serviceable forms



Servento

Design
Achille Castiglioni
della serie Servi di Achille
& Pier Giacomo Castiglioni
1986

P: 1° Premio 5 Stelle Tecnhotel
1986.

C: Thessaloniki Design
Museum, Saloniki.



Servostop

Design
Achille Castiglioni
della serie Servi di Achille
& Pier Giacomo Castiglioni
1984

P: 1° Premio 5 Stelle Tecnhotel
1986.

C: Thessaloniki Design
Museum, Saloniki.



Giotto

Design
De Pas, D'Urbino, Lomazzi
1975

C: Kunstgewerbemuseum,
Zürich; Die Neue Sammlung,
München.



Un classico
ultramoderno

An ultramodern classic

Chichibio

Design
G. Levi Montalcini, G. Pagano Pogatschnig
1932

Base x height = layered tops



Base x altezza = piani d'appoggio

Riverberi di *sensualità*

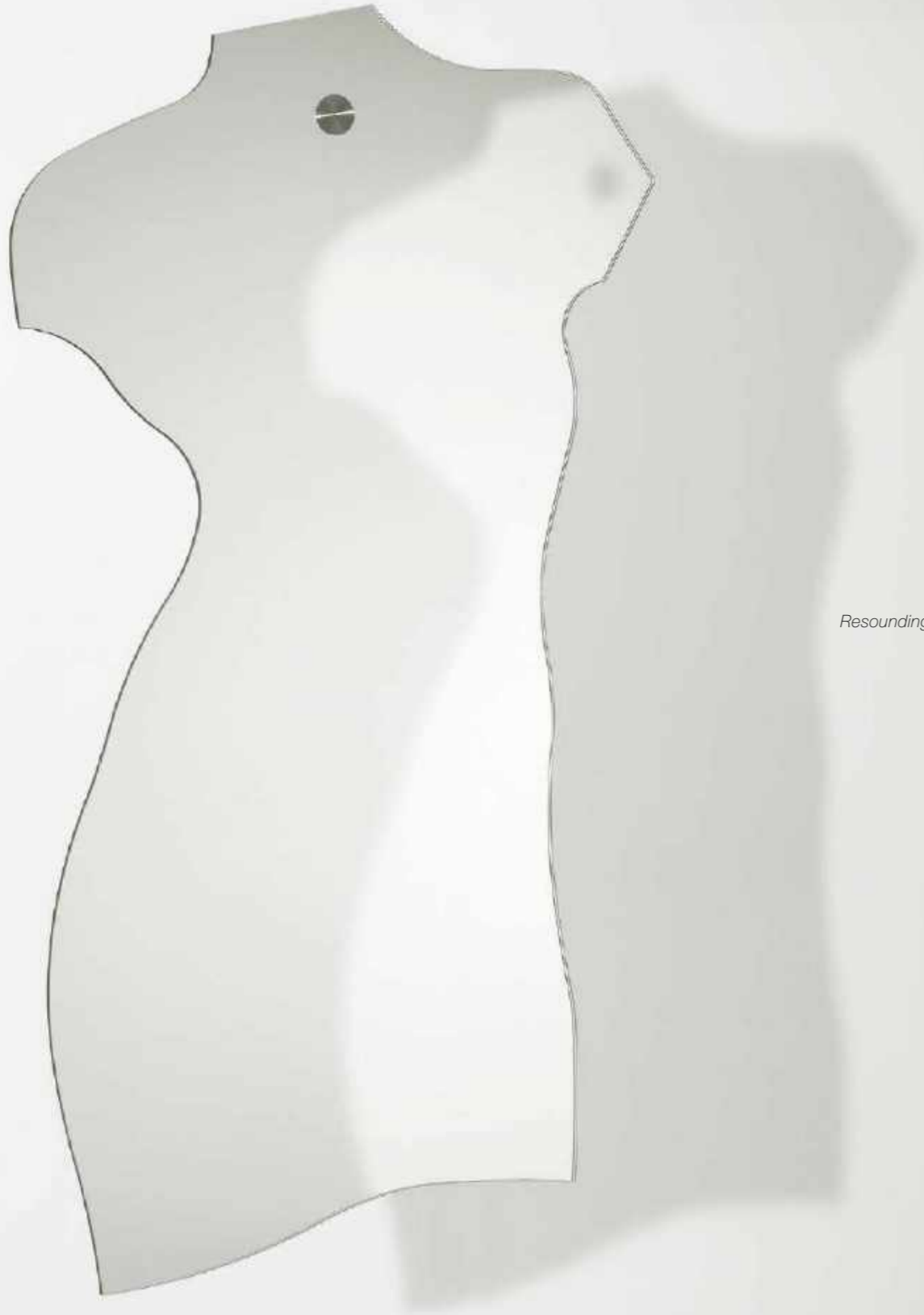

Resounding sensuality



Pablo

Design
Gabriele Rosa
2008

Riflessi dalle mille

sfaccettature



Multifaceted reflections

Raperonzolo

Design
Atelier Oi
2015



Un *intreccio* sospeso

Intertwining suspension

Veryround

Design
Louise Campbell
2006

P: Good Design Award 2006.

C: The Museum of Modern Art, New York; The Designmuseum Danmark, Copenhagen; The Montreal Museum of Fine Arts; Die Neue Sammlung, München; Philadelphia Museum of Art;

Dallas Museum of Art; Musée National d'Art Moderne, Paris; Trapholt Museum, Kolding; Museum für Kunst und Gewerbe, Hamburg; Design Museo, Helsinki.

La tecnologia che *seduce*

The allure of technology

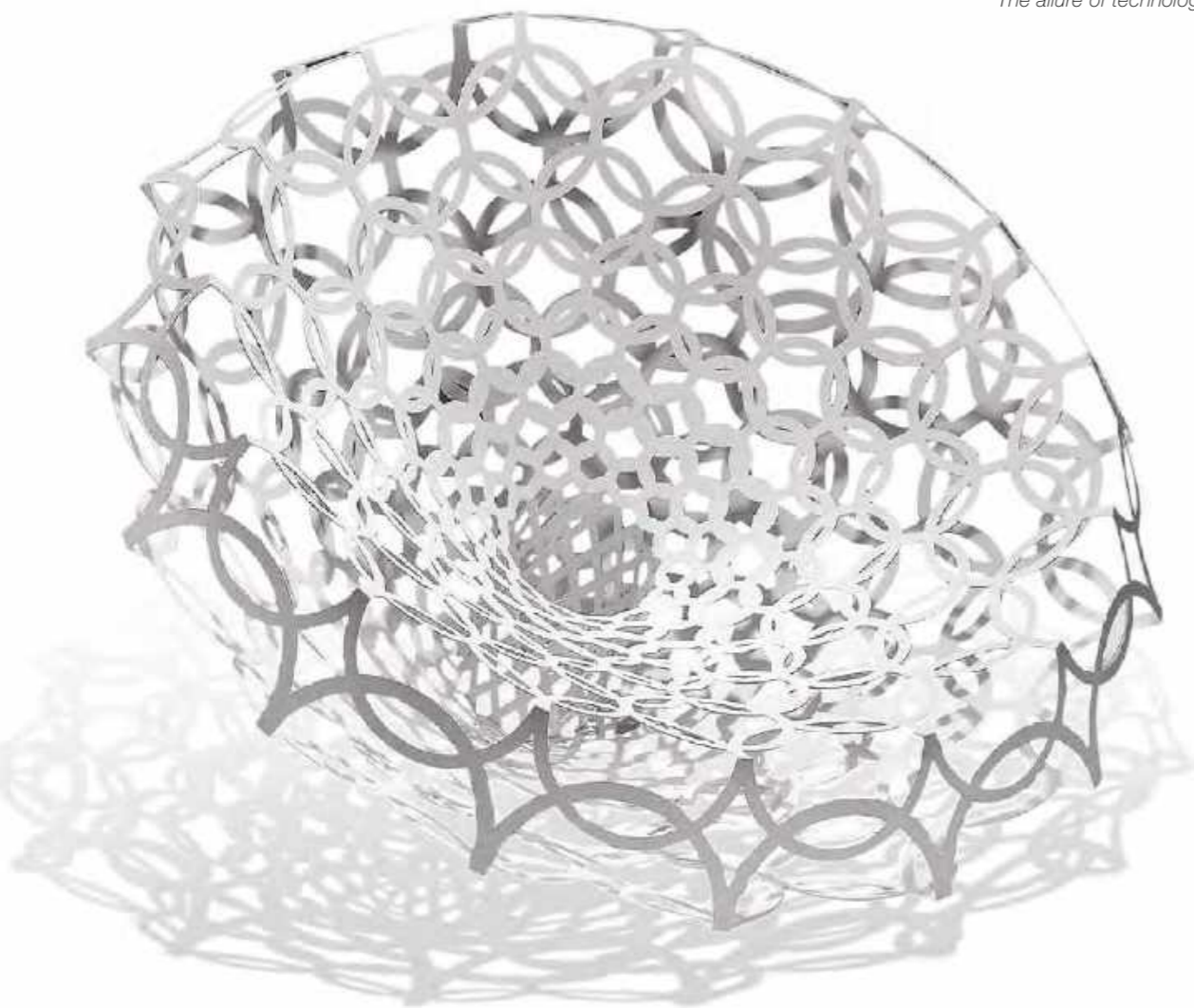

"Il progetto si basa sul piacere che si può trovare nella ripetizione. Un cerchio singolo non è particolarmente interessante ma 240 cerchi, meticolosamente disposti fino a formare una seduta intera, lo sono. La seduta, sebbene occupi spazio e sia solida, sembra leggera come la carta. Nessuna gamba, nessun giunto, nessuno dettaglio che si associa normalmente ad una sedia è presente. Fondamentalmente si tratta di una grande coppa aperta nella quale chiunque è il benvenuto a sedersi e a dondolarsi dolcemente."
In realtà Veryround è una seduta complessa: la lamiera di 2 mm di spessore è tagliata con un laser 3D per ottenere una leggerezza formale e una solidità strutturale sorprendenti.

"The project revolves around the pleasure provided by repetition. A single circle is not particularly interesting, but 240 circles, meticulously arranged to compose a proper seat, certainly are. Regardless of the fact that the seat occupies considerable space and is solid, it still seems as light as paper. Not a single leg, joint, or detail that is normally associated with a chair can be found. Basically, it is a large, open cup in which anyone is invited to take a seat and rock gently."
In reality, Veryround is a complex chair: the 2mm-thick sheet metal is cut with a 3-D laser in order to obtain formal lightness along with surprising structural solidity.

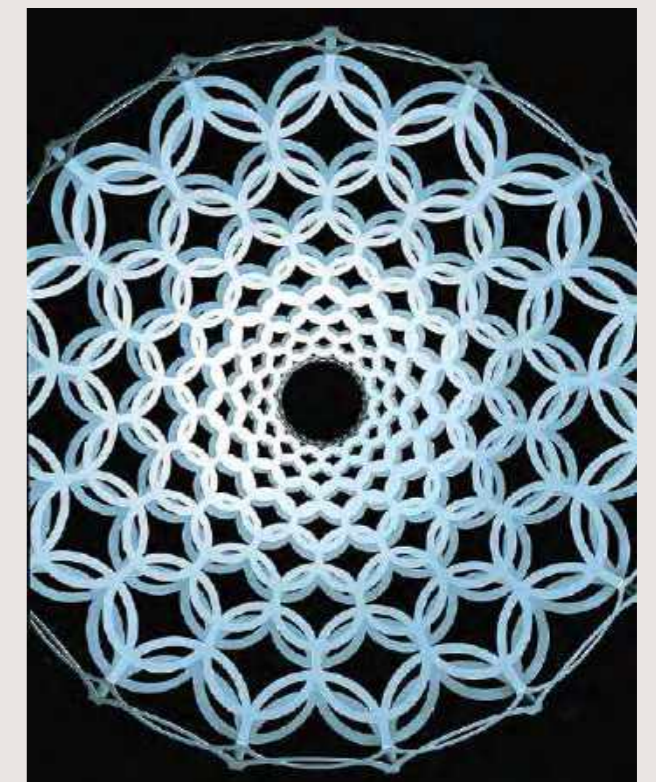

Divani
Sofas
Canapés
Sofas
Sofás

1335
Bruce

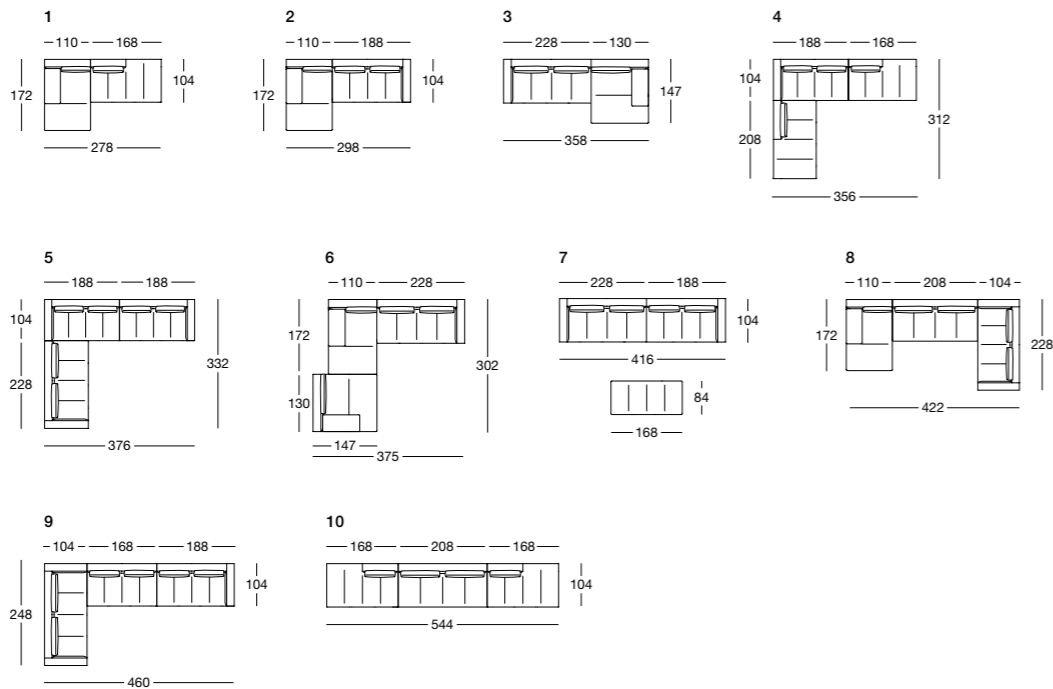
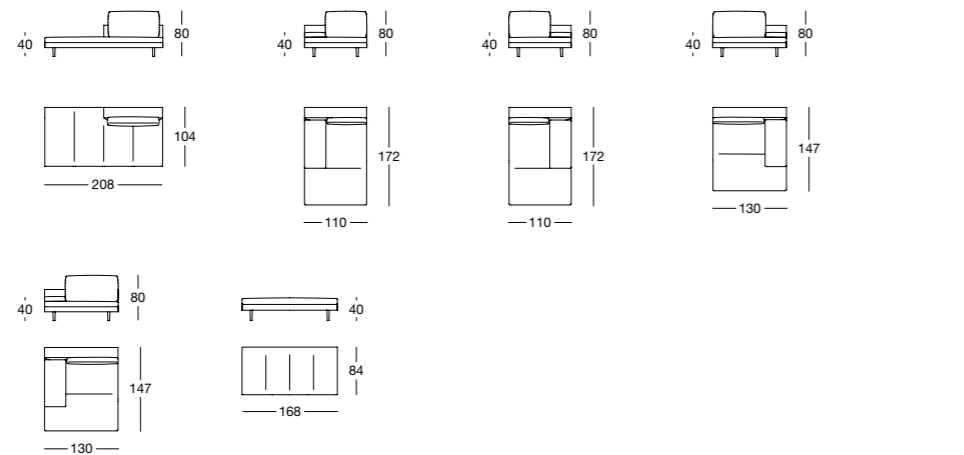
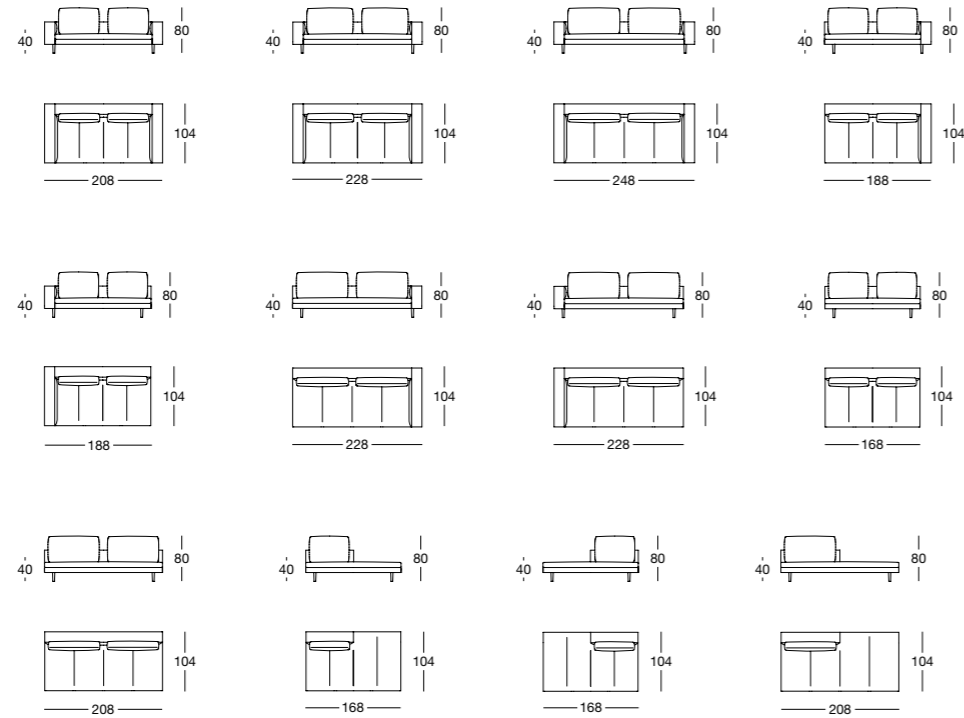

Esempi di composizione
Examples of compositions
Exemples de compositions
Beispiele zur Komposition der Elemente
Ejemplos de composiciones

1009
Club
Prospero Rasulo
2008

IN / OUT

Poltrona e divano per esterni e interni
Struttura interna in acciaio verniciato per esterni. Incordatura in filo di PVC con rinforzo interno di nylon colore marrone. A richiesta è disponibile un cuscinetto di seduta imbottito in poliuretano/Dacron Du Pont.

Armchair and sofa for outdoor and indoor
Steel internal structure painted for outdoor use. Weave in brown PVC thread with nylon internal reinforcement. Upon request a small seat cushion upholstered with polyurethane/Dacron Du Pont is available.

Fauteuil et canapé pour extérieurs et intérieurs
Structure interne en acier verni pour extérieurs. Tressage en fil de PVC avec renfort interne en nylon, couleur marron. Sur demande est disponible un coussinet du siège rembourré en polyuréthane/Dacron Du Pont.

Sessel und Sofa für Innen und Freie
Innere Struktur aus lackiertem Stahl fürs Freie. Geflecht aus PVC Draht mit innerer Verstärkung aus Nylon in der Farbe braun. Auf Nachfrage ist ein gepolstertes Sitzkissen mit Polyurethan/Dacron Du Pont verfügbar.

Sillón y sofá para exteriores y interiores
Estructura interior de acero pintado para exteriores. Trenzado en hilo de PVC con refuerzo interno de nylon color marrón. Sobre pedido es disponible un cojín pequeño de asiento acolchado de poliuretano/Dacron Du Pont.

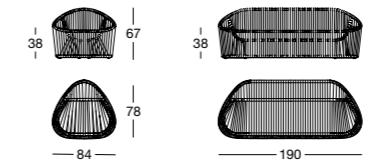

1325
Dove
Ludovica+Roberto Palomba
2020

Divani monoblocco e componibili
Piedi in fusione di lega di alluminio verniciati colore grafite. Struttura seduta in legno. Molleggio su nastri elastici. Struttura schienali e braccioli in acciaio. Imbottitura sedile in poliuretano a quote differenziate/ fibra poliestere termolegata. Imbottitura schienali e braccioli in poliuretano schiumato autoestinguente/fibra poliestere termolegata. Rivestimento sfilabile in stoffa o in pelle.

Monobloc and modular sofas
Graphite painted aluminium alloy feet. Wooden seat frame. Elastic strips suspension. Steel backrest and armrests. Seat upholstered with graduated polyurethane/ heat-bound polyester fibre. Backrest and armrests upholstered with self-extinguishing polyurethane foam/heat-bound polyester fibre. Removable fabric or leather cover.

Canapés monoblocs et composables
Pieds en alliage d'aluminium verni graphite. Structure d'assise en bois. Suspension sur sangles élastiques. Dossier et accoudoirs en acier. Rembourrage d'assise en polyuréthane à densité variable/fibre polyester liée à chaud. Rembourrage du dossier et des accoudoirs en mousse de polyuréthane autoextinguible/fibre de polyester liée à chaud. Revêtement déhoussable en tissu ou cuir.

Einteilige und zusammenstellbare Sofas
Füße aus graphitfarbener Aluminiumlegierung. Sitzgestell aus Holz. Federung mit elastischen Gurten. Rücken- und Armlehne aus Stahl. Sitzpolsterung aus Polyurethan in unterschiedlicher Dichte/ wärmegebundener Polyesterfaser. Polsterung der Rücken- und Armlehne aus selbstlöschendem Polyurethanschaum/ wärmegebundener Polyesterfaser. Abnehmbarer Bezug aus Stoff oder Leder.

Sofas monobloque y modulares
Patatas de aleación de aluminio pintado grafito. Estructura de asiento de madera. Suspensión sobre cintas elásticas. Estructura del respaldo y apoyabrazos de acero. Acolchado del asiento de poliuretano a densidades diferenciadas/ fibra poliéster termounida. Acolchado del respaldo y de los apoyabrazos de espuma de poliuretano autoextintivo/ fibra poliéster termounida. Tapizado desenfundable de tejido o de piel.

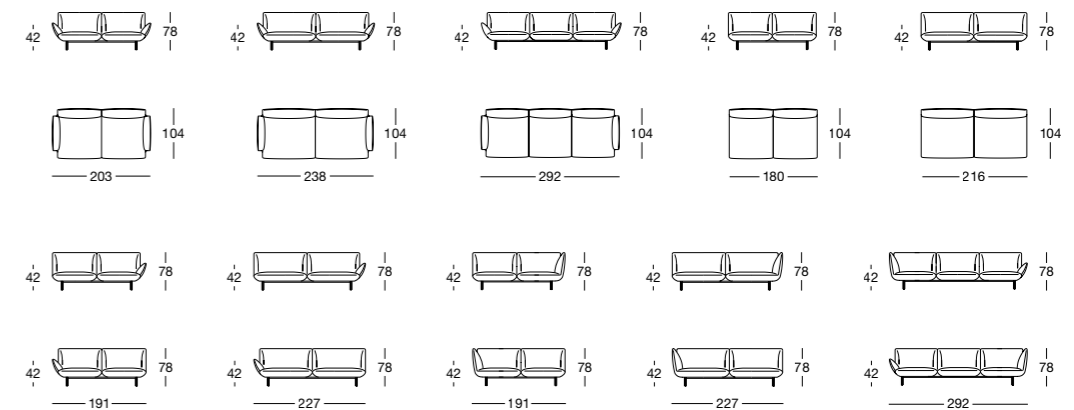

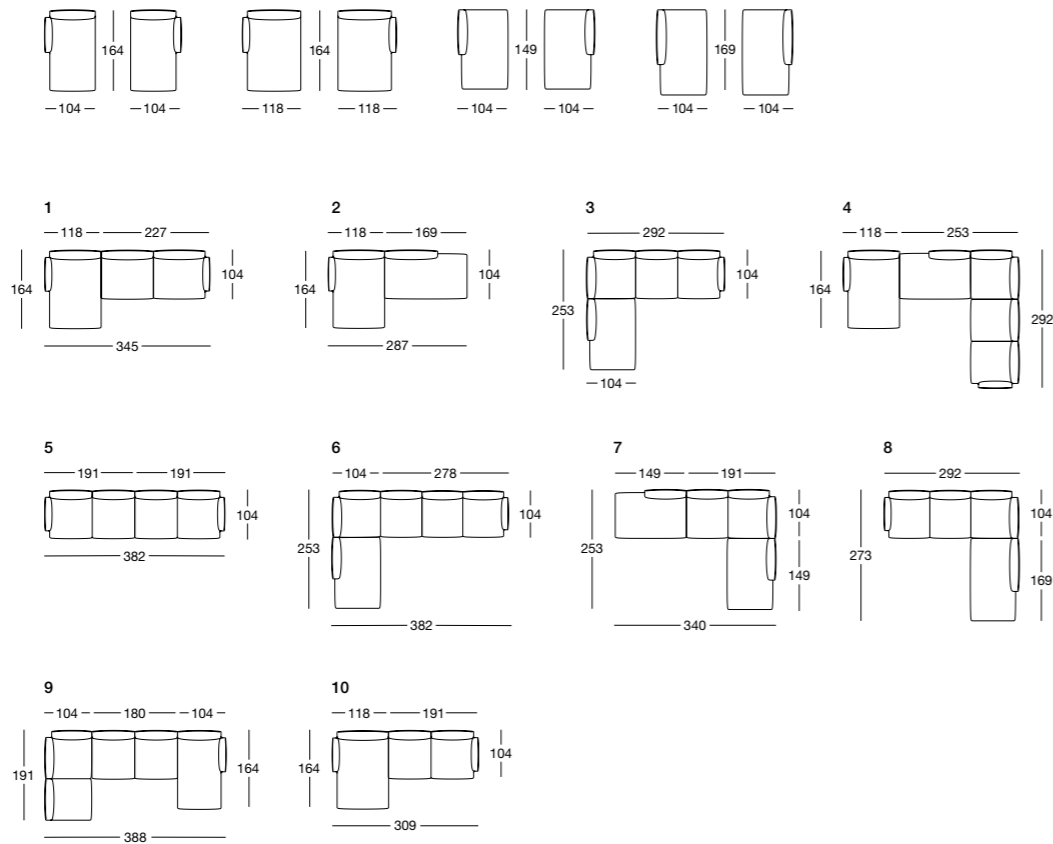
1325
DoveEsempi di composizione
Examples of compositions
Exemples de compositions
Beispiele zur Komposition der Elemente
Ejemplos de composiciones1333
Flamingo
Damian Williamson
2017

Poltrona, divani monoblocco e componibili
Piedini in lega di alluminio lucidato, nichelsatinato colore naturale o nero, oppure verniciato colore nero. Struttura in acciaio. Molleggio su nastri elastici. Imbottitura in poliuretano/fibra poliestere termolegata. Cuscino seduta in poliuretano/fibra poliestere termolegata. Imbottitura cuscini schienale e poggiatesta in piuma d'oca. Rivestimento sfilabile in stoffa o in pelle.

Armchair, monobloc and modular sofas.
Polished or black painted aluminum alloy feet, or with natural or black nickel-satin finish. Steel frame. Elastic strips suspension. Upholstery in polyurethane/heat-bound polyester fibre. Seat cushion upholstered with polyurethane/heat-bound polyester fibre. Back and lumbar cushions upholstered with goose feathers. Removable fabric or leather cover.

Fauteuil et canapés monoblocs et composables
Pieds en alliage d'aluminium poli, ou nickel satiné, dans les couleurs naturel ou noir, ou vernis noir. Structure en acier. Suspension sur sangles élastiques. Rembourrage en polyuréthane/fibre polyester liée à chaud. Coussins d'assise en polyuréthane/fibre polyester liée à chaud. Rembourrage en plume d'oie. Revêtement déhoussable en tissu ou en cuir.

Sessel, einteilige und zusammenstellbare Sofas
Füße aus polierter oder schwarz-lackierter Aluminiumlegierung, oder mit naturfarbenen- oder schwarz vernickeltem und mattiertem Finish. Gestell aus Stahl. Federung auf elastischen Gurten. Polsterung aus Polyurethan/wärmegebundener Polyesterfaser. Sitzkissen aus Polyurethan/wärmegebundener Polyesterfaser. Polsterung der Rücken- und Nierenkissen aus Gänsefedern. Abnehmbarer Bezug aus Stoff oder Leder.

Butaca, sofás monobloque y modulares
Patas de aleación de aluminio pulido, o niquelado mate en los acabados natural o negro, o pintado negro. Estructura de acero. Suspensión sobre cintas elásticas. Acolchado de poliuretano/fibra poliéster termounida. Cojín asiento de poliuretano/fibra poliéster termounida. Cojín de respaldo y lumbar acolchados con pluma de ganso. Tapizado desenfundable de tejido o de piel.

Piedini / Feet / Pieds / Füsse / Patas

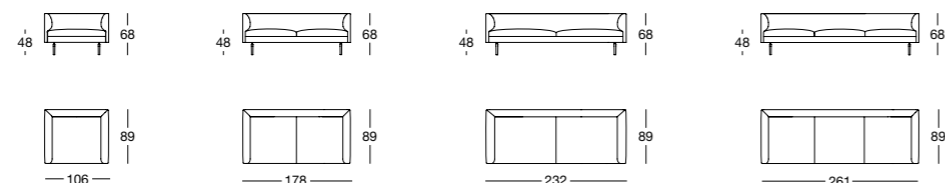
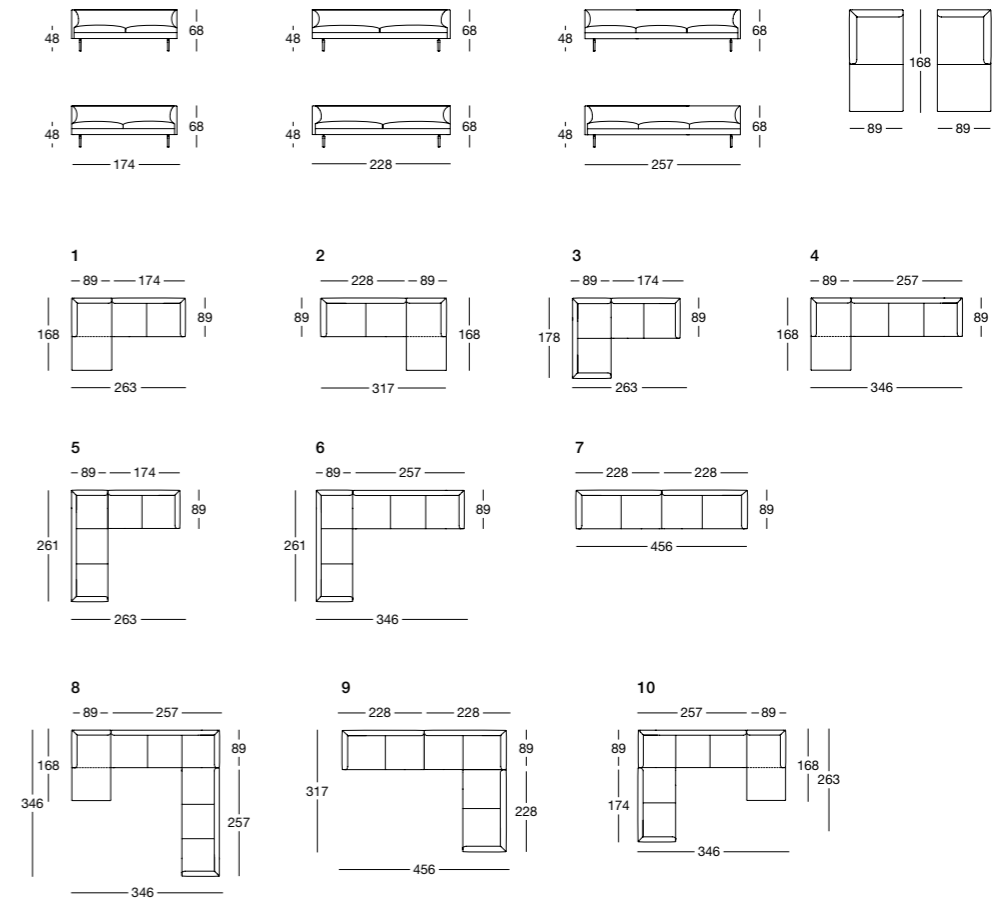
1333
FlamingoEsempi di composizione
Examples of compositions
Exemples de compositions
Beispiele zur Komposition der Elemente
Ejemplos de composiciones1327
Hiro
Damian Williamson
2018

Divani monoblocco e componibili
Piedini in lega di alluminio lucidato, nichelsatinato colore naturale o nero. Struttura in acciaio. Molleggio su nastri elastici. Imbottitura struttura in poliuretano/fibra poliestere termolegata. Cuscino seduta in poliuretano/fibra poliestere termolegata. Cuscino schienale in Solotex®. Rivestimento sfilabile in stoffa o in pelle.

Monobloc and modular sofas
Aluminum alloy feet, either polished or with natural or black nickel-satin finish. Steel frame. Elastic strips suspension. Frame upholstered with polyurethane/heat-bound polyester fibre. Seat cushion in polyurethane/heat-bound polyester fibre. Back cushion in Solotex®. Removable cover in fabric or leather.

Canapés monoblocs et composables
Pieds en alliage d'aluminium poli ou nickel-satiné, dans les couleurs naturel ou noir. Structure en acier. Suspension sur sangles élastiques. Rembourrage structure en polyuréthane/fibre polyester liée à chaud. Coussin du siège en polyuréthane/fibre polyester liée à chaud. Coussin du dossier en Solotex®. Revêtement déhoussable en tissu ou cuir.

Einteilige und zusammenstellbare Sofas
Füße aus polierter Aluminiumlegierung, oder mit naturfarbenen- oder schwarz vernickeltem und mattiertem Finish. Stahl-Gestell. Federung auf elastischen Gurten. Gestell mit Polsterung aus Polyurethan/wärmegebundener Polyesterfaser. Rücken- und Nierenkissen aus Solotex®. Abnehmbarer Bezug aus Stoff oder Leder.

Sofás monobloque y modulares
Patas de aleación de aluminio pulido o niquelado mate en los acabados natural o negro. Estructura de acero. Suspensión sobre cintas elásticas. Acolchado estructura de poliuretano/fibra poliéster termounida. Cojín asiento de poliuretano/fibra poliéster termounida. Cojín respaldo de Solotex®. Tapizado desenfundable de tejido o de piel.

Piedini / Feet / Pieds / Füsse / Patas

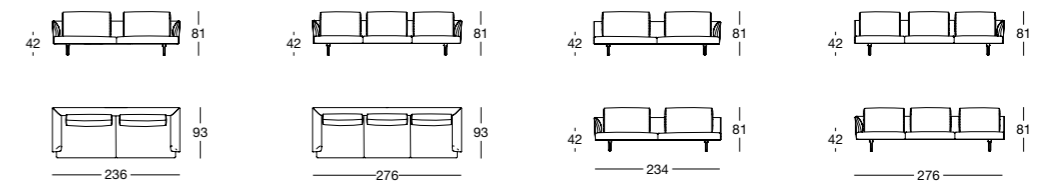

1322
Kim
 Ludovica+Roberto Palomba
 2018

Divani monoblocco e componibili
 Piedini in lega di alluminio lucidato, nichel-satinato colore naturale o nero. Struttura in legno. Molleggio su nastri elastici. Imbottitura schienale e sedile in poliuretano/fibra poliestere termolegata. Rivestimento sfilabile in stoffa o in pelle. È disponibile un cuscino poggiatesta accessorio. In alternativa al piedino standard, è disponibile una variante con piedino "arco".

Monobloc and modular sofas
 Aluminum alloy feet, either polished or with natural or black nickel-satin finish. Wooden frame. Elastic strips suspension. Backrest and seat upholstered with polyurethane/heat-bound polyester fibre. Removable cover in fabric or leather. A headrest cushion is available as option. As an alternative to the standard foot, a variant with an "arco" foot is available.

Canapés monoblocs et composables
 Pieds en alliage d'aluminium poli ou nickel-satiné, dans les couleurs naturel ou noir. Structure en bois. Suspension sur sangles élastiques. Rembourrage du dossier et du siège en polyuréthane/fibre de polyester liée à chaud. Revêtement déhoussable en tissu ou cuir. Un coussin appuie-tête est disponible en option. Comme alternative au pied standard, une variante avec un pied "arco" est disponible.

Einteilige und zusammenstellbare Sofas
 Füße aus polierter Aluminiumlegierung, oder mit naturfarben- oder schwarz-vernickeltem und mattiertem Finish. Holz-Gestell. Federung auf elastischen Gurten. Sitz und Rücken-Polsterung aus Polyurethan/wärmegebundener Polyesterfaser. Abnehmbarer Bezug aus Stoff oder Leder. Eine Kopfstütze ist als Zubehör verfügbar. Als Alternative zum Standardfuß steht eine Variante mit einem Fuß "arco" zur Verfügung.

Sofás monobloque y modulares
 Patas de aleación de aluminio pulido o niquelado mate en los acabados natural o negro. Estructura de madera. Suspensión sobre cintas elásticas. Acolchado del respaldo y del asiento de poliuretano/fibra poliéster termounida. Tapizado desenfundable de tejido o de piel. Cojín de apoyo para la cabeza disponible. Como alternativa al pie estándar, está disponible una variante con pie "arco".

Piedini / Feet / Pieds / Füsse / Patas

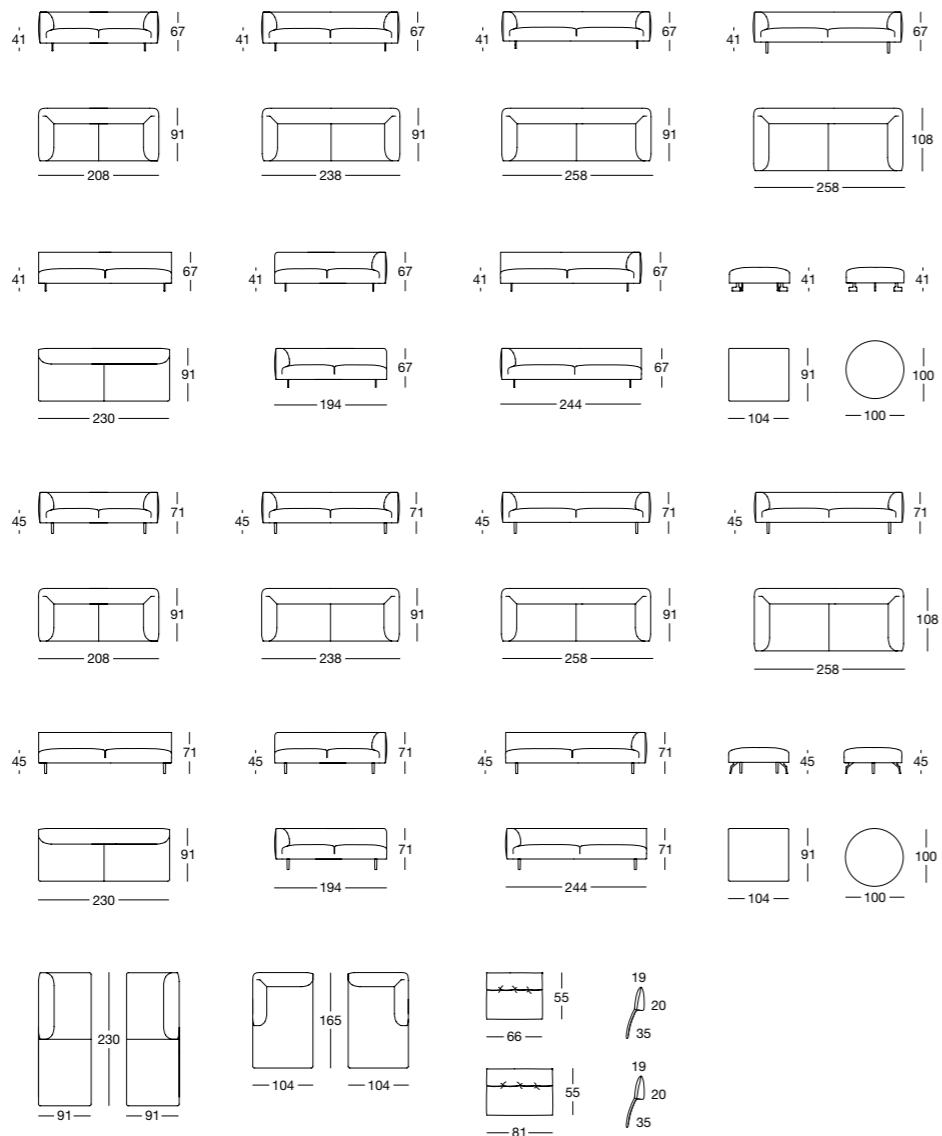

1322
Kim
 Esempi di composizione
 Examples of compositions
 Exemples de compositions
 Beispiele zur Komposition der Elemente
 Ejemplos de composiciones

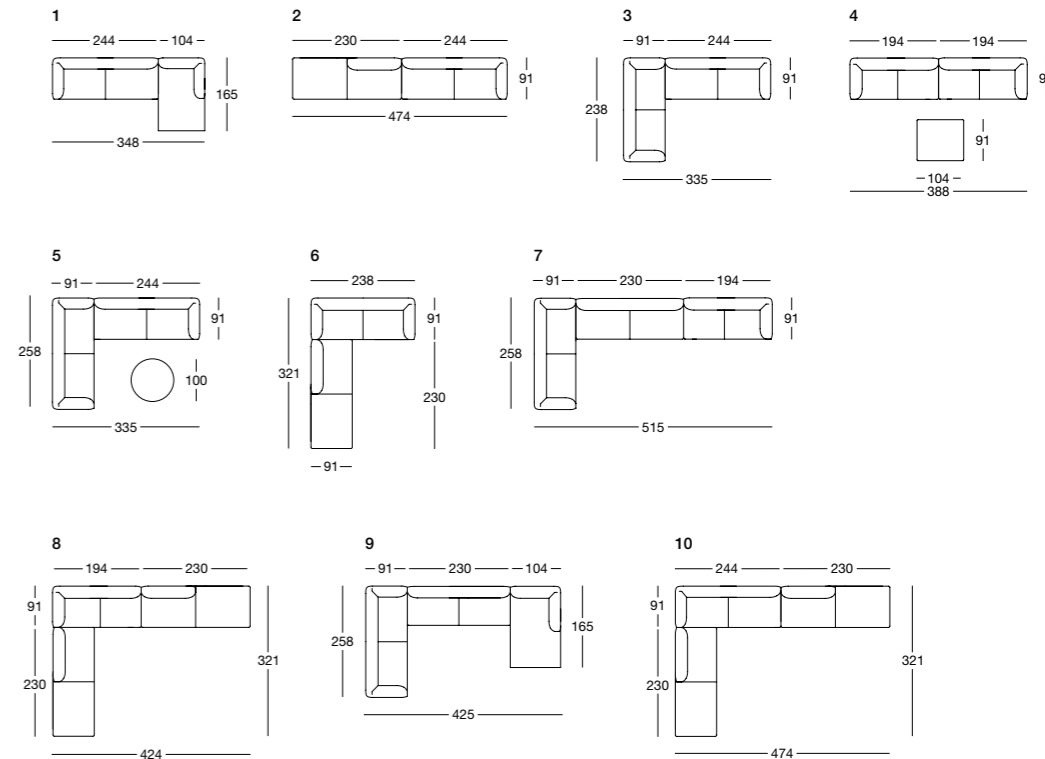

1039
Milano+
 De Pas, D'Urbino, Lomazzi
 1982-2019

Divani monoblocco, componibili e pouf
 Piedini in lega di alluminio nichel-satinato colore naturale o nero. Struttura in acciaio. Molleggio su nastri elastici. Cuscino seduta unico in poliuretano/fibra poliestere termolegata; cuscini schienale in Solotex® e braccioli in Solosoft®. Rivestimento sfilabile in stoffa o in pelle.

Monobloc, modular sofas and pouf
 Aluminum alloy feet, with natural or black nickel-satin finish. Steel frame. Elastic strips suspension. Single seat cushion in polyurethane/heat-bound polyester fibre; backrest cushions in Solotex® and armrests in Solosoft®. Removable fabric or leather cover.

Canapés monoblocs, composables et pouf
 Pieds en alliage d'aluminium nickel satiné dans les finitions naturelle ou noire. Structure en acier. Suspension sur sangles élastiques. Coussin siège d'une seule pièce en polyuréthane/fibre de polyester liée à chaud; coussins dossier en Solotex® et accoudoirs en Solosoft®. Revêtement déhoussable en tissu ou en cuir.

Einteilige, zusammenstellbare Sofas und Hocker
 Füße aus Alu-Legierung, mit naturfarben- oder schwarz-vernickeltem und mattiertem Finish. Gestell aus Stahl. Federung mit elastischen Gurten. Einteilige Sitzpolsterung aus Polyurethan/wärmegebundener Polyesterfaser; Rückenkissen aus Solotex® und Armlehnen aus Solosoft®. Abnehmbarer Bezug aus Stoff oder Leder.

Sofás monobloque, modulares y puf
 Patas de aleación de aluminio niquelado mate en los acabados natural o negro. Estructura de acero. Asiento sobre cintas elásticas. Cojín de asiento único de poliuretano/fibra poliéster termounida; cojines de respaldo de Solotex® y apoyabrazos de Solosoft®. Tapizado desenfundable de tejido o de piel.

Piedini / Feet / Pieds / Füsse / Patas

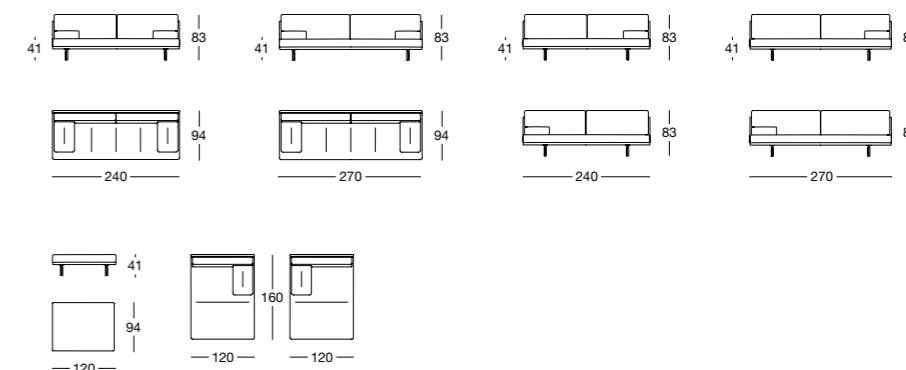

1039
Milano+

Esempi di composizione
Examples of compositions
Exemples de compositions
Beispiele zur Komposition der Elemente
Ejemplos de composiciones

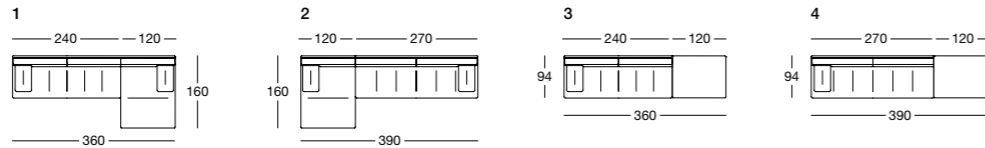

1030
Onda
De Pas, D'Urbino, Lomazzi
1985

Poltrona e divani monoblocco
Struttura portante in tubo di acciaio inox. Imbottitura in poliuretano/fibra poliester termolegata. Rivestimento sfilabile in stoffa o in pelle. La sfoderabilità è resa possibile solamente da personale specializzato.

Armchair and monobloc sofas
Stainless steel tubular frame. Upholstery in polyurethane/heat-bound polyester fibre. Removable fabric or leather cover. The cover can be removed only by skilled staff.

Fauteuil et canapés monoblocs
Structure portante en tube d'acier inox. Rembourrage en polyuréthane fibre polyester liée à chaud. Revêtement déhoussable en tissu ou en cuir. Il est possible de déhousser le canapé seulement par un personnel spécialisé.

Sessel und einteilige Sofas
Tragendes Gestell aus Inox-Stahlrohr. Polsterung aus Polyurethan/wärmegebundene Polyesterfaser. Abnehmbarer Bezug aus Stoff oder Leder. Der Bezug kann nur vom Fachpersonal abgenommen werden.

Butaca y sofás monobloque
Estructura portante de tubo de acero inox. Acolchado de poliuretano/fibra poliéster termounida. Tapizado desenfundable de tejido o de piel. Es posible quitar la funda solo de personal especializado.

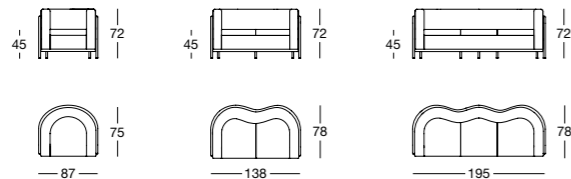

1034
Parco
Emaf Progetti
2011

IN / OUT

Divani monoblocco e pouf per esterni
Struttura portante in acciaio verniciato per esterni, colore bianco o nero. Molleggio su nastri elastici. Cuscini seduta, schienale e bracciolo in poliuretano reticolato a cellula aperta/Paineira, fibra vegetale idrorepellente. Rivestimento sfilabile in tessuto Talasso.

Monobloc sofas and pouf for outdoor use
Supporting frame in painted steel for outdoor use in the shade of white or black. Elastic strips suspension. Seat, back and armrest cushion in open cell reticulated polyether/Paineira, water-repellent vegetal fibre. Removable cover in fabric Talasso.

Canapés monoblocs pour extérieur
Structure portante en acier verni pour extérieurs, couleur blanc ou noir. Suspension sur sangles élastiques. Coussins d'assise, dossier et accoudoir en polyéther réticulé à cellule ouverte/Paineira, fibre végétale hydrofuge. Revêtement déhoussable en tissu Talasso.

Einteilige Sofas fürs Freie
Tragendes Gestell mit Lackierung fürs Freie, in den Farben weiß oder schwarz. Federung auf elastischen Gurten. Sitzkissen, Rücken und Armlehne aus vernetztem Polyether mit offenen Zellen/Paineira, Pflanzenfaser, wasserabweisend. Abnehmbarer Bezug aus Stoff Talasso.

Sofás monobloque para exteriores
Estructura portante de acero barnizada para exteriores color blanco o negro. Suspensión sobre cintas elásticas. Cojines de asiento, respaldo y apoyabrazo de poliéter reticulado con célula abierta/Paineira, fibra vegetal hidrorrepelente. Tapizado desenfundable de tejido Talasso.

Struttura / Frame / Structure / Gestell / Estructura

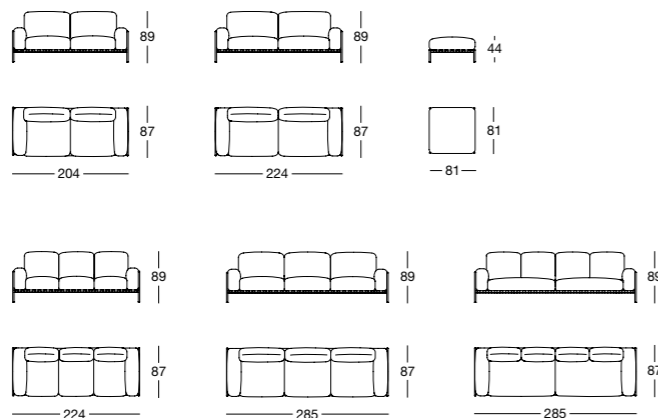

1272 / 1273
Pianoalto
Pianoalto 96
Ludovica+Roberto Palomba
2012

Divani monoblocco, componibili, pouf
Piedini in acciaio verniciati colore grafite. Struttura in acciaio. Molleggio su nastri elastici. Imbottitura sedile in poliuretano/Dacron Du Pont con inserto trapuntato in piuma d'oca. Imbottitura schienale e braccioli in poliuretano/Dacron Du Pont con inserto trapuntato in piuma d'oca e fiocchi di fibra poliester. Imbottitura cuscini schienale in poliuretano/Dacron Du Pont o in piuma d'oca. Rivestimento sfilabile in stoffa o in pelle.

Monobloc and modular sofas, pouf
Graphite painted steel feet. Steel frame. Elastic strips suspension. Seat upholstered in polyurethane/Dacron Du Pont with quilted insert of goose feathers. Backrest and armrests upholstered in polyurethane/Dacron Du Pont with quilted insert of goose feathers and polyester fibre flakes. Back cushions upholstered in polyurethane/Dacron Du Pont or in goose feathers. Removable cover in fabric or leather.

Canapés monoblocs, composables, pouf
Pieds en acier verni graphite. Structure en acier. Suspension sur sangles élastiques. Rembourrage de l'assise en polyuréthane/Dacron Du Pont avec insertion matelassé en plume d'oie. Rembourrage du dossier et des accoudoirs en polyuréthane/Dacron Du Pont avec insertion matelassé en plume d'oie et flocons de fibre polyester. Rembourrage des coussins du dossier en polyuréthane/Dacron Du Pont ou en plume d'oie. Revêtement déhoussable en tissu ou en cuir.

Einteilige, zusammenstellbare Sofas, Hocker
Füße aus Graphitfarben lackiertem Stahl. Gestell aus Stahl. Federung auf elastischen Gurten. Sitzpolsterung aus Polyurethan/Dacron Du Pont mit Steppeinsatz aus Gänsefedern. Polsterung von Arm- Rückenlehne aus Polyurethan/ Dacron Du Pont mit Steppeinsatz aus Gänsefedern und Flocken aus Polyesterfasern. Polsterung der Rückenissen aus Polyurethan/Dacron Du Pont oder aus Gänsefedern. Abnehmbarer Bezug aus Stoff oder Leder.

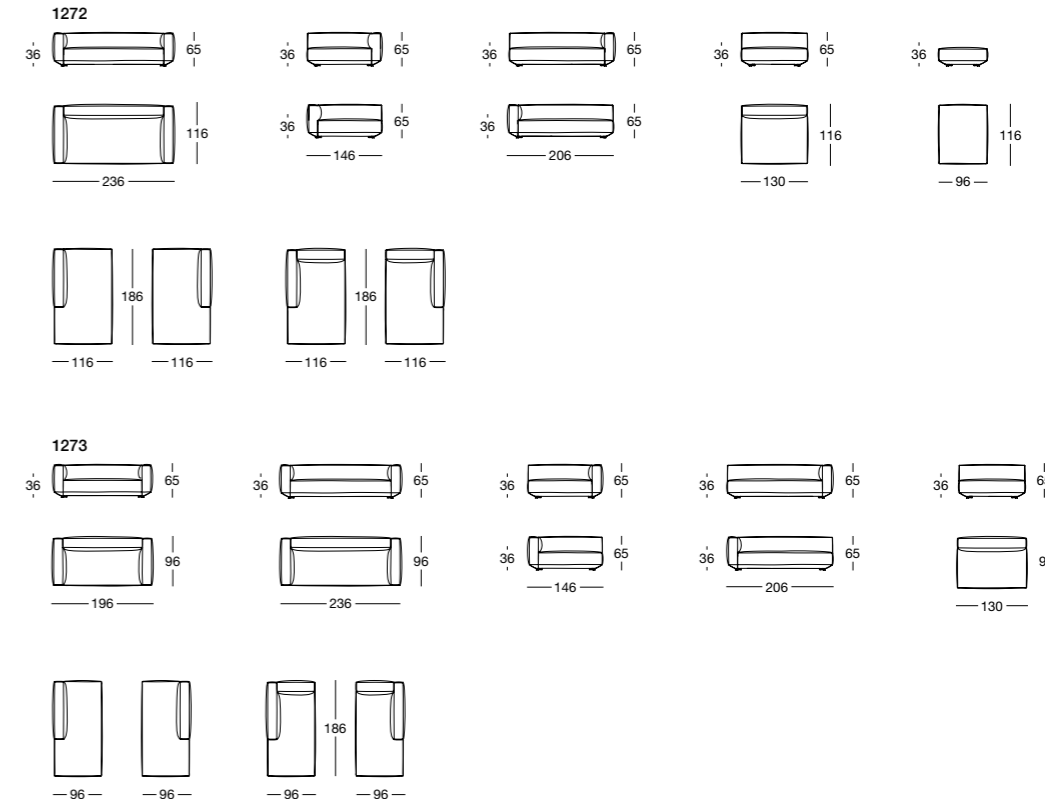

Esempi di composizione
Examples of compositions
Exemples de compositions
Beispiele zur Komposition der Elemente
Ejemplos de composiciones

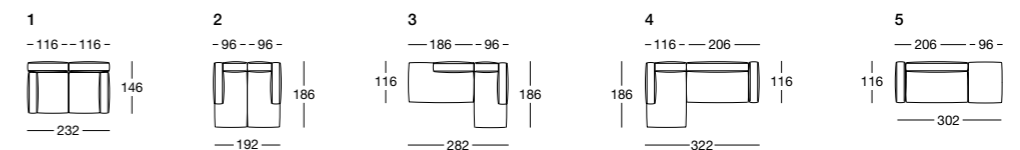

1272 / 1273
Pianoalto
Pianoalto 96

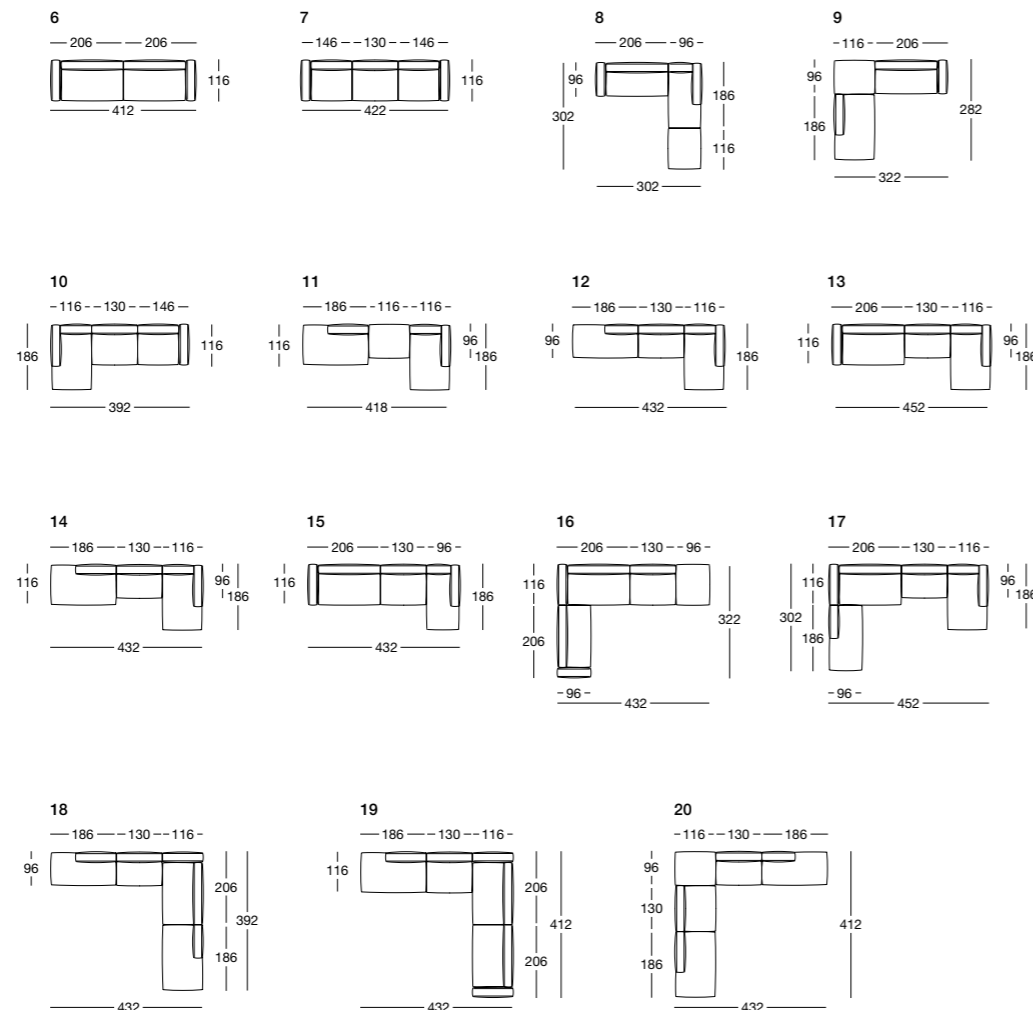

1235
Scott
Ludovica+Roberto Palomba
2014

Poltrona, divani monoblocco, componibili, pouf

Piedini in lega di alluminio lucidato o nichelato lucido colore nero. Struttura in acciaio. Molleggio su nastri elastici. Imbottitura in poliuretano/Dacron Du Pont. Cuscino seduta in poliuretano/fibra poliestere termolegata. Cuscino schienale in piuma d'oca-materiale 100% vergine. Rivestimento sfilabile in stoffa o in pelle. È disponibile anche la versione con scocca in pelle 99 e cuscini in stoffa.

Pouf trapuntato

Piedini in lega di alluminio lucidato o nichelato lucido colore nero. Basamento in legno multistrato. Imbottitura in poliuretano/fibra poliestere. Rivestimento trapuntato con fibra poliestere termolegata, sfilabile, in stoffa o in pelle.

Armchair, monobloc, modular sofas, pouf

Polished aluminum alloy or nickel-plated glossy black feet. Steel frame. Elastic strips suspension. Upholstery in polyurethane/Dacron Du Pont. Seat cushion in polyurethane/heat-bound polyester fibre. Back cushion in 100% new goose feather. Removable fabric or leather cover. The version with the sling in leather 99 and cushions covered with fabric is also available.

Quilted pouf

Polished aluminum alloy or nickel-plated glossy black feet. Base in multi-layered wood. Upholstery in polyurethane/polyester fibre. Removable quilted cover with heat bound polyester fibre, in fabric or leather.

Fauteuil, canapés monobloc, composables, pouf

Pieds en alliage d'aluminium poli ou nickelé poli noir. Structure en acier. Suspension sur sangles élastiques. Rembourrage en polyuréthane/Dacron Du Pont. Coussin du siège en polyuréthane/fibre polyester liée à chaud. Coussin du dossier en plume d'oie - matériau 100% vierge. Revêtement déhoussable en tissu ou en cuir. C'est disponible aussi une version avec la coque en cuir 99 et les coussins en tissu.

Pouf surpiqué

Pieds en alliage d'aluminium poli ou nickelé poli noir. Base en contreplaqué. Rembourrage en polyuréthane/fibre polyester. Revêtement surpiqué avec fibre polyester liée à chaud, déhoussable en tissu ou en cuir.

1235
Scott

Sessel, einteilige, zusammenstellbare Sofas, Hocker

Füße aus polierter Aluminiumlegierung oder vernickelt glänzend, schwarz. Stahlgestell. Federung auf elastischen Gurten. Polsterung aus Polyurethan/Dacron Du Pont. Sitzkissen aus Polyurethan/wärmegebundener Polyesterfaser. Rückenkissen aus 100% reinen Gänsfedern. Abnehmbarer Bezug aus Stoff oder Leder. Die Ausführung mit Schale aus Leder 99 und Kissen mit Stoff-Bezug ist auch verfügbar.

Gesteptes Hocker

Füße aus polierter Aluminiumlegierung oder vernickelt glänzend, schwarz. Unterteil aus Sperrholz. Polsterung aus Polyurethan/Polyesterfaser. Abnehmbarer Bezug gesteppt, mit wärmegebundener Polyesterfaser, aus Stoff oder Leder.

Butaca, sofás monobloque, modulares y púf

Patas de aleación de aluminio pulido o niquelado brillante color negro. Estructura de acero. Suspensión sobre cintas elásticas. Acolchado de poliuretano de densidades diferenciadas/Dacron Du Pont. Cojín de asiento de poliuretano/fibra poliéster termounida. Cojín de respaldo de pluma de ganso - material 100% virgen. Tapizado de tejido o de piel. La versión con casco en piel 99 y cojines tapizados en tejido esta también disponible.

Púf pespunteado

Patas de aleación de aluminio pulido o niquelado brillante color negro. Base en multicapas de madera. Acolchado de poliuretano/fibra poliéster. Tapizado pespunteado con fibra poliéster termounida, desenfundable de tejido o de piel.

Piedini / Feet / Pieds / Füße / Patas

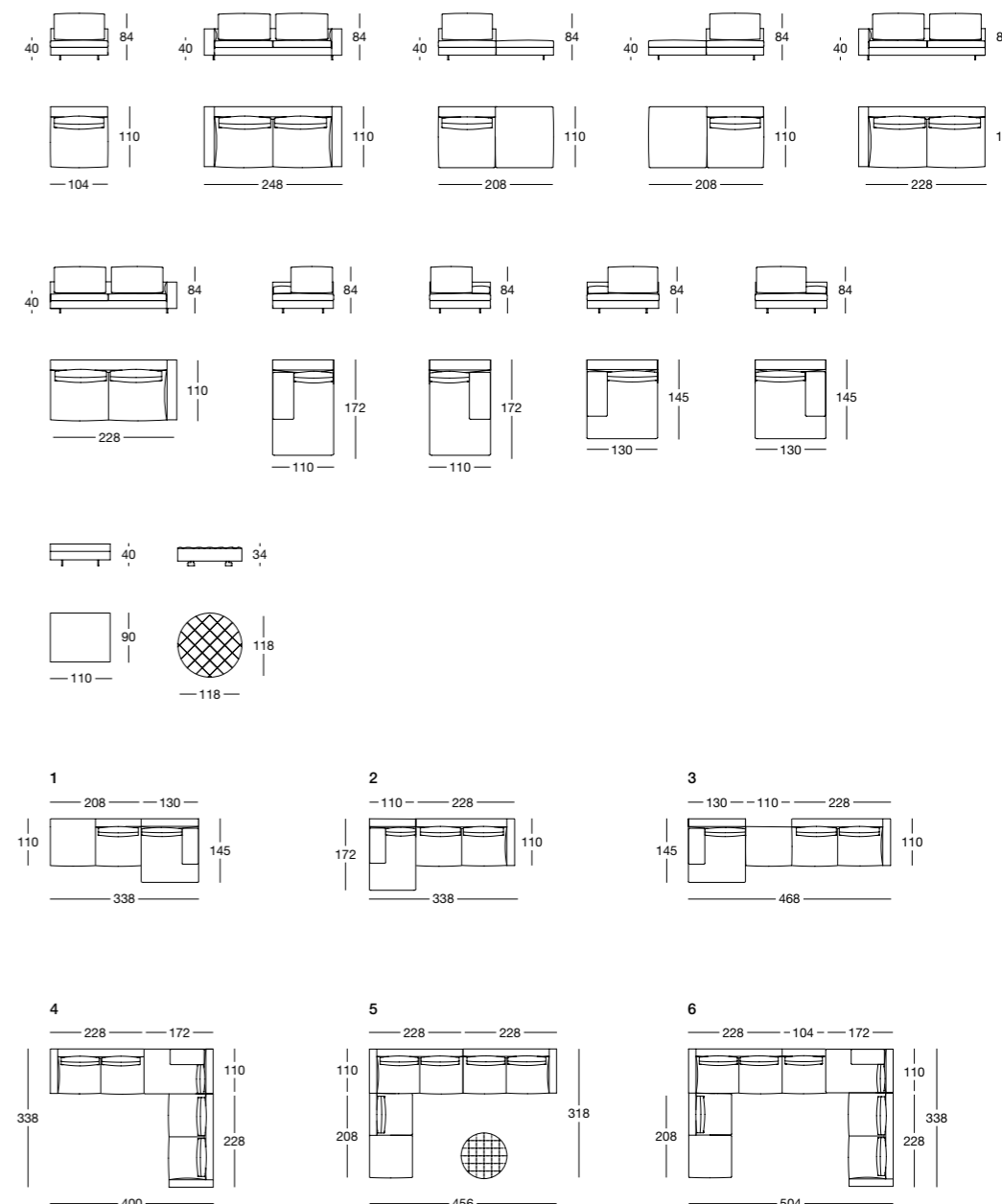

Esempi di composizione
Examples of compositions
Exemples de compositions
Beispiele zur Komposition der Elemente
Ejemplos de composiciones

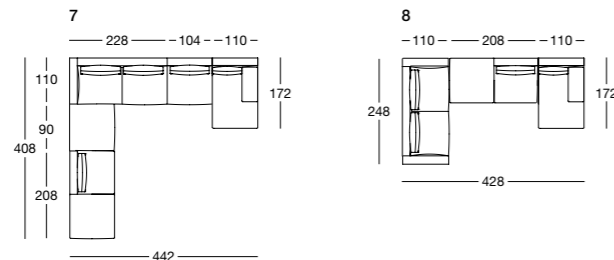
1235
Scott1247
Shiki
Damian Williamson
2019

Divani monoblocco e componibili
Base in legno rivestita nello stesso tessuto o pelle del divano. Struttura in legno. Molleggio su nastri elastici. Imbottitura schienale e sedile in poliuretano/fibra poliestere termolegata. Cuscino schienale in piuma d'oca - materiale 100% vergine. Cuscino a rullo in poliuretano/fibra poliestere termolegata. Rivestimento con cuscino seduta trapuntato, sfilabile in stoffa o in pelle. A richiesta, per i divani monoblocco, è disponibile la versione con tutti gli schienali alti.

Monobloc and modular sofas
Wooden base covered with the same fabric or leather of the sofa. Wooden frame. Elastic strips suspension. Backrest and seat upholstered with polyurethane/heat-bound polyester fibre. Backrest cushion in 100% new goose feathers. Roll-shaped cushion in polyurethane/heat-bound polyester fibre. Removable fabric or leather cover with quilted seat cushion. Upon request, only for the monobloc sofas, the version with all higher backrests is available.

Canapés monoblocs et composables
Embasement en bois revêtu dans le même tissu ou cuir du canapé. Structure en bois. Suspension sur sangles élastiques. Rembourrage du dossier et du siège en polyuréthane/fibre de polyester liée à chaud. Coussin dossier en plume d'oie - matériel 100% vierge. Coussin cale-reins en polyuréthane/fibre polyester liée à chaud. Revêtement avec coussin siège surpiqué, déhoussable en tissu ou en cuir. Sur demande, pour les canapés monoblocs, il est disponible une version avec tous les dossiers hauts.

Einteilige und zusammenstellbare Sofas
Holzsockel mit dem gleichen Stoff oder Leder Bezug des Sofas. Holzgestell. Federung mit elastischen Gurten. Polsterung der Rückenlehne und Sitz aus Polyurethan/wärmegebundener Polyesterfaser. Rückenkissen mit 100% reinen Gänsefedern. Nierenrolle-Kissen aus Polyurethan/wärmegebundener Polyesterfaser. Abnehmbarer Bezug mit Steppung über den Sitzpolstern aus Stoff oder Leder. Auf Nachfrage, nur für die einteilige Sofas, ist die Ausführung mit allen höhen Rückenlehnen verfügbar.

Sofás monobloque y modulares
Base en madera tapizada con el mismo tejido o piel del sofá. Estructura en madera. Suspensión sobre cintas elásticas. Acolchado del respaldo y del asiento en poliuretano/fibra poliéster termounida. Cojín de respaldo en pluma de ganso, material 100% virgen. Cojín lumbar en poliuretano/fibra poliéster termounida. Tapizado con cojín de asiento pespunteado, desenfundable de tejido o de piel. Sobre pedido, para los sofás monobloque, está disponible la versión con los respaldos altos.

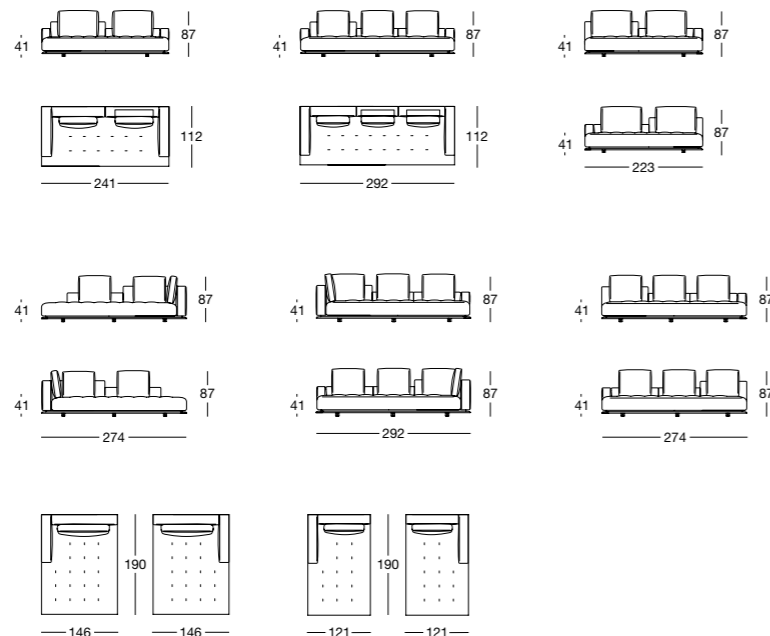
1247
Shiki

Esempi di composizione
Examples of compositions
Exemples de compositions
Beispiele zur Komposition der Elemente
Ejemplos de composiciones

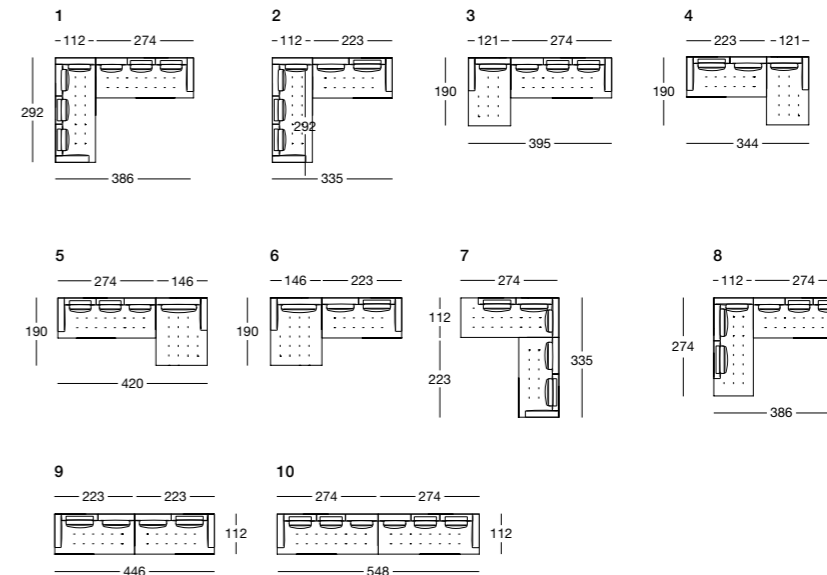
1150
Throw-Away
Willie Landels
1965

Poltrona, divani e pouf
Struttura in poliuretano espanso. Rivestimento sfilabile in stoffa o in pelle.

Armchair, sofas and pouf
Expanded polyurethane frame. Removable cover in fabric or leather.

Fauteuil, canapés et pouf
Structure en polyurethane expansé. Revêtement déhoussable en tissu ou en cuir.

Sessel, Sofas und Hocker
Gestell aus Polyurethan-Schaum. Abnehmbarer Bezug aus Stoff oder Leder.

Butaca, sofas y pouf
Estructura de poliuretano espanso. Tapizado desenfundable de tejido o de piel.

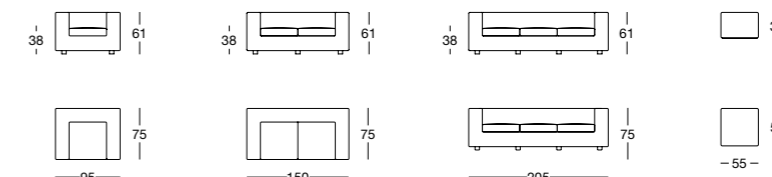
1330
William
Damian Williamson
2010

Poltrona, divani monoblocco, componibili, pouf, dormeuse e mensole
Piedini in lega di alluminio lucidato, nichelsatinato colore naturale o nero, oppure verniciato nero. Struttura in acciaio. Molleggio su nastri elastici. Imbottitura in poliuretano/fibra poliestere termolegata. Cuscini seduta, schienale e bracciolo in piuma d'oca. Rivestimento sfilabile in stoffa o in pelle. Le poltrone allungate senza bracciolo e i divani terminali sono predisposti per l'attacco di una mensola in legno massello di rovere verniciato colore naturale o tinto grigio oppure in noce Canaletto verniciato colore naturale. Reggi-mensole in alluminio lucidato, nichelsatinato colore naturale o nero, o verniciato nero.

Armchair, monobloc, modular sofas, pouf, day bed and shelves
Aluminum alloy feet, either polished or with natural or black nickel-satin finish, or black painted. Steel frame. Elastic strips suspension. Upholstery in polyurethane/heat-bound polyester fibre. Seat, back and armrest cushions upholstered with goose down. Removable fabric or leather cover. The lounge chairs without armrest and the end-sofas are fit to arrange a solid wood shelf, in natural or grey painted oak or in natural painted Canaletto walnut. Shelf supports in polished, with natural or black nickel-satin finish, or black painted aluminum.

Fauteuil, canapés monoblocs, composables, pouf, dormeuse et étagères
Pieds en alliage d'aluminium poli, ou nickel-satiné, dans les couleurs naturel ou noir, ou verni noir. Piètement en acier. Suspension sur sangles élastiques. Rembourrage en polyuréthane/fibre polyester liée à chaud. Coussins d'assise, dossier et accoudoirs en plume d'oie. Revêtement déhoussable en tissu ou en cuir. Les fauteuils allongés sans accoudoir et les canapés composables sont prédisposés pour l'accrochage d'une étagère en bois massif rouvre verni naturel ou teinté gris ou en noyer Canaletto verni naturel. Supports d'étagère en aluminium poli, ou nickelsatiné, dans les couleurs naturel ou noir, ou verni noir.

1330
William

Sessel, einteilige, zusammenstellbare Sofas, Hocker, Liege und Stützfläche
 Füße aus polierter Aluminiumlegierung, oder mit naturfarben- oder schwarz vernickeltem und mattiertem Finish, oder schwarz lackiert. Gestell aus Stahl. Federung auf elastischen Gurten. Polsterung aus Polyurethan/wärmegebundener Polyesterfaser. Sitz-, Rücken und Armlehnenpolsterung aus Gänsefedern. Abnehmbarer Bezug aus Stoff oder Leder. Die Liege-Sessel ohne Armlehne und die zusammenstellbaren Sofas werden zur Befestigung einer Stützfläche ausgestattet, die entweder aus Massivholz in naturfarbener oder graugebeizter Eiche, oder in naturfarben lackiertem Nussbaum Canaletto erhältlich ist. Stützfläche-Träger aus poliertem Aluminium, oder mit naturfarben- oder schwarz vernickeltem und mattiertem Finish, oder schwarz lackiert.

Butaca, sofás monobloque, modulares, púf, butacas alargadas y repisas
 Patas de aleación de aluminio pulido o niquelado mate en los acabados natural o negro, o pintado negro. Estructura de acero. Suspensión sobre cintas elásticas. Acollchado de poliuretano/fibra poliéster termounida. Cojines asiento, respaldo y apoyabrazo de pluma de ganso. Tapizado desenfundable de tejido o de piel. Las butacas alargadas sin apoyabrazos y los sofás modulares se preparan para fijar una repisa en madera maciza de roble pintado color natural o teñido gris, o en nogal Canaletto pintado color natural. Soportes de las repisas en aluminio pulido o niquelado mate en los acabados natural o negro, o pintado negro.

Piedini / Feet / Pieds / Füße / Patas

Reggi Mensole / Shelf supports / Supports d'étagère / Stützfläche-Träger / Soportes repisa

Mensole / Shelves / Étagères / Stützfläche/Repisas

| | |
|---|--|
| | |
| Rovere naturale Natural oakwood Rouvre naturel Naturfarbene Eiche Roble natural | Noce Canaletto Canaletto walnut Noyer Canaletto Nussbaum Canaletto Nogal Canaletto |
| | |
| Rovere tinto grigio Grey varnished oak Rouvre teinté gris Grau-gebeizte Eiche Roble teñido gris | |

1330
William

Esempi di composizione
 Examples of compositions
 Exemples de compositions
 Beispiele zur Komposition der Elemente
 Ejemplos de composiciones

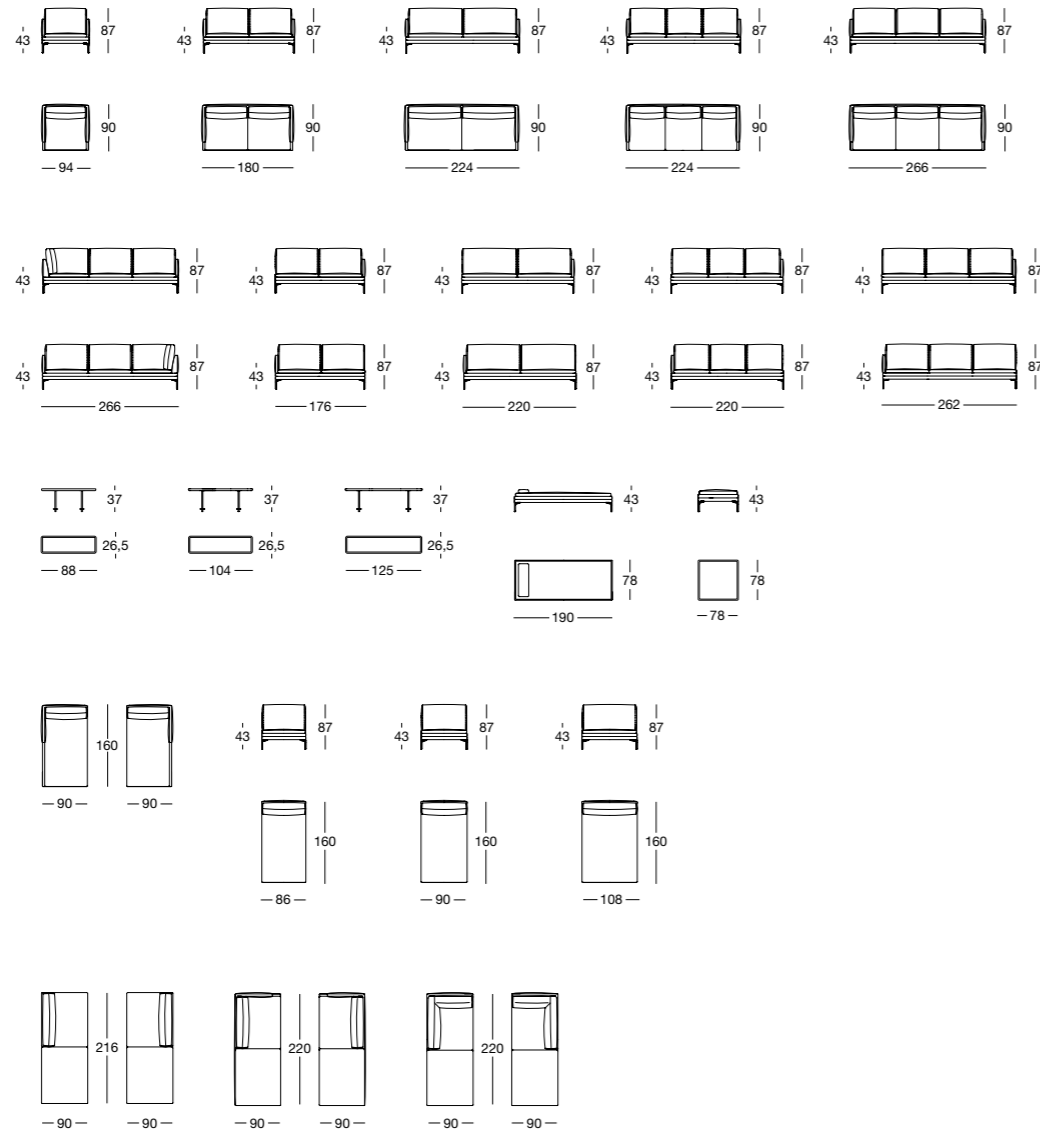
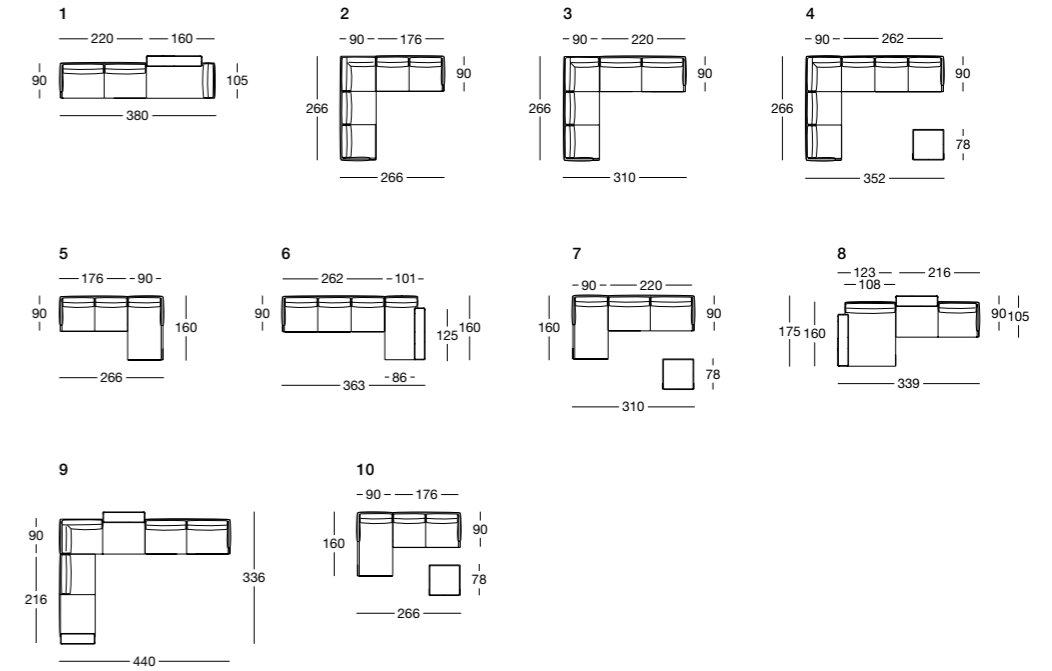

**Poltrone
Armchairs
Fauteuils
Sessel
Butacas**

882

Ardea CMOmaggio a Carlo Mollino
1946**Poltrona / Bergère**

Base in legno massello di rovere naturale o tinto nero oppure in legno massello di noce Canaletto colore naturale; verniciatura con finitura a cera. Struttura in acciaio con molleggio su nastri elastici. Imbottitura in poliuretano/fibra poliestere termolegata. Rivestimento sfilabile in stoffa o pelle.

Armchair / Bergère

Base in solid natural or black varnished oak, or in solid natural Canaletto walnut; wax-finished varnish. Steel frame, with elastic strips suspension. Upholstery in polyurethane/heat-bound polyester fibre. Removable cover in fabric or leather.

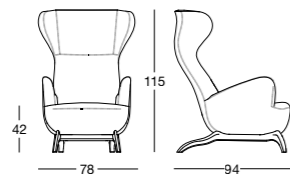
**Fauteuil / bergère**

Socle en rouvre naturel massif ou teinté noir ou en noyer Canaletto massif, couleur naturelle; verni finition cirée. Structure en acier avec suspension sur sangles élastiques. Rembourrage en polyuréthane/fibre de polyester liée à chaud. Revêtement déhoussable en tissu ou en cuir.

Sessel / Bergère

Sockel aus massiver naturfarbener oder schwarz lackierter Eiche, oder aus massivem naturfarbenem Nussbaum Canaletto; Lackierung mit Wachs-Endbehandlung. Gestell aus Stahl mit Federung auf elastischen Gurten. Polsterung aus Polyurethan/wärmegebundener Polyesterfaser. Abnehmbarer Bezug aus Stoff oder Leder.

Butaca de orejas

Base en madera maciza de roble natural o teñido negro o en madera maciza de nogal Canaletto color natural; pintura con acabado de cera. Estructura de acero con suspensión sobre cintas elásticas. Acolchado de poliuretano/fibra poliéster termounida. Tapizado desenfundable en tejido o piel.

Base / Base / Socle / Sockel / Base

872

AromNoé Duchaufour Lawrance
2014**Poltroncina**

Struttura in acciaio. Imbottitura in poliuretano/fibra poliestere termolegata con molleggio su nastri elastici. Rivestimento sfilabile in stoffa, Pied de poule o in pelle. La scocca esterna può essere rivestita anche in cuoio 95 in abbinamento a tessuto o pelle.

Armchair

Steel frame. Upholstery with polyurethane/heat bound polyester fibre with elastic strips suspension. Removable cover in fabric, Pied de poule or leather. The exterior body can be covered with cowhide 95, combined with fabric or leather.

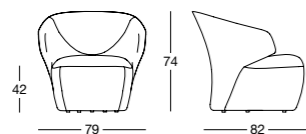
**Petit fauteuil**

Structure en acier. Rembourrage en polyuréthane/fibre polyester liée à chaud avec suspension sur sangles élastiques. Revêtement déhoussable en tissu, Pied de poule ou en cuir. La coque extérieure peut également être revêtue en cuir sellier 95 en combinaison avec du tissu ou de cuir.

Kleiner Sessel

Gestell aus Stahl. Polsterung aus Polyurethan/wärmegebundener Polyesterfaser mit Federung auf elastischen Gurten. Abnehmbarer Bezug aus Stoff, aus Pied de poule oder Leder. Die Sitzschale kann außen mit Kernleder 95 in Kombination mit Stoff oder Leder bezogen werden.

Butaquita

Estructura de acero. Acolchado de poliuretano/fibra poliéster termounida con suspensión sobre cintas elásticas. Tapizado desenfundable de tejido, Pied de poule o de piel. El bastidor exterior puede ser tapizado en cuero 95 en combinación con tejido o piel.

873

CallaNoé Duchaufour Lawrance
2010**Poltroncina**

Base su ruote o fissa con piedini. Struttura in acciaio. Imbottitura in poliuretano/fibra poliestere termolegata con molleggio su nastri elastici. Rivestimento sfilabile in stoffa o in pelle. La scocca esterna può essere rivestita anche in cuoio 95 in abbinamento a tessuto o pelle. La poltroncina è disponibile in due differenti altezze da terra: alta 873/A con rotelle, bassa 873/B con piedini.

Armchair

Base on castors or fixed with feet. Steel frame. Upholstery with polyurethane/heat bound polyester fibre with elastic strips suspension. Removable fabric or leather cover. The exterior body can be covered with cowhide 95, combined with fabric or leather. The armchair is available in two different heights above ground level: high 873/A with castors, low 873/B with feet.

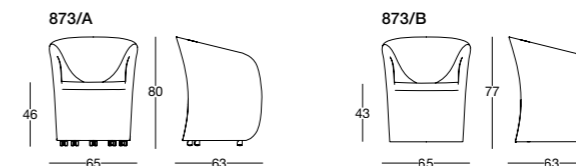
**Petit fauteuil**

Base sur roulettes ou fixe avec pieds. Piètement en acier. Rembourrage de polyuréthane/fibre polyester liée à chaud avec suspension sur sangles élastiques. Revêtement déhoussable en tissu ou en cuir. La coque extérieure peut également être revêtue en cuir sellier 95 en combinaison avec du tissu ou de cuir. Le fauteuil est disponible en deux hauteurs du sol: haut 873/A avec roulettes, bas 873/B avec pieds.

Kleiner Sessel

Sockel auf Rollen oder fest mit Füßen. Gestell aus Stahl. Polsterung aus Polyurethan/wärmegebundener Polyesterfaser mit Federung auf elastischen Gurten. Abnehmbarer Bezug aus Stoff oder Leder. Die Sitzschale kann außen mit Kernleder 95 in Kombination mit Stoff oder Leder bezogen werden. Der kleine Sessel ist in zwei verschiedenen Höhen ab Boden erhältlich: hoch 873/A mit Rollen, niedrig 873/B mit Füßen.

875

DerbyNoé Duchaufour Lawrance
2009-2010**Poltrona / bergère, pouf**

Poltrona con base girevole in acciaio o fissa con piedini e scocca esterna in poliuretano rigido rivestita in cuoio 95. Imbottitura scocca interna e pouf in poliuretano/fibra poliestere termolegata con molleggio su nastri elastici. Rivestimento sfilabile in stoffa o in pelle. Struttura pouf in acciaio.

Armchair / bergère, pouf

Armchair with steel base, swivel or fixed with feet and stiff polyurethane exterior body covered with cowhide 95. Upholstery of internal body and pouf in polyurethane/heat-bound polyester fibre with elastic strips suspension. Removable fabric or leather cover. Pouf steel frame.

Fauteuil / Bergère, pouf

Fauteuil avec base pivotante en acier ou fixée avec pieds et coque extérieure en polyuréthane rigide, revêtue en cuir sellier 95. Rembourrage de la coque intérieure et pouf en polyuréthane/fibre polyester liée à chaud avec suspension sur sangles élastiques. Revêtement déhoussable en tissu ou en cuir. Structure pouf en acier.

Sessel / Bergère, Hocker

Sessel mit Stahlsockel, drehbar oder fest mit Füßen und äußere Sitzschale aus steifem Polyurethan, mit Kernleder 95 bezogen. Innere Sitzschale und Hocker mit Polsterung aus Polyurethan/wärmegebundener Polyesterfaser mit Federung auf elastischen Gurten. Abnehmbarer Bezug aus Stoff oder Leder. Hocker-Gestell aus Stahl.

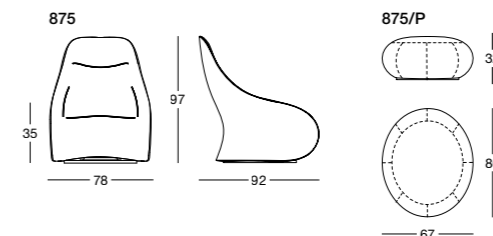

920

GenniGabriele Mucchi
1935**Chaise longue**

Struttura in acciaio cromato, o nichelsatinato colore naturale o nero, oppure verniciato nero. Molleggio su spirali di acciaio. Seduta regolabile su due posizioni. Imbottitura cuscino seduta e poggiatesta in poliuretano. Rivestimento cuscini e braccioli in pelle.

Lounge chair

Chromium-plated steel frame or with natural or black nickel-satin finish, or black painted. Suspension on steel springs. Adjustable seat in two positions. Cushion and headrest upholstered in polyurethane. Leather-covered cushions and armrests.

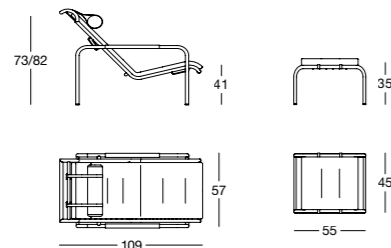
**Chaise longue**

Structure en acier chromé, nickel satiné, dans les finitions naturelle ou noire, ou en acier verni noir. Suspension à spirales d'acier. Assise réglable en deux positions. Coussin et appuie-tête en polyuréthane. Revêtement coussins et accoudoirs en cuir.

Chaiselongue

Gestell aus verchromtem oder schwarz-lackiertem Stahl, oder mit naturfarben- oder schwarz-vernicheltem und mattiertem Finish. Federung auf Stahlfedern. Sitzhöhe zweifach regulierbar. Kissen und Kopfrolle aus Polyurethan. Kissen- und Armlehnenbezug aus Leder.

Sillón

Estructura de acero cromado, o niquelado mate en los acabados natural o negro, o pintada de color negro. Muelles de espiral de acero. Asiento regulable en dos posiciones. Cojín y apoyacabeza acolchados de poliuretano. Tapizado cojines y apoyabrazos de piel.

Struttura / Frame / Structure / Gestell / Estructura

890

JudyFrank Rettenbacher
2017**Poltroncina**

Gambe in acciaio verniciato colore grafite o nero. Sedile in poliuretano rigido con imbottitura in poliuretano. Rivestimento sfilabile in stoffa o in pelle. Schienale in multistrato di faggio placcato in rovere verniciato naturale o tinto nero oppure placcato in noce Canaletto verniciato colore naturale. Imbottitura schienale e cuscino sedile amovibile, rispettivamente in poliuretano e in poliuretano schiumato autoestinguente. Rivestimento sfilabile in stoffa o in pelle.

Armchair

Black or graphite painted steel legs. Stiff polyurethane seat with polyurethane upholstery. Removable cover in fabric or leather. Backrest in beech plywood, covered with natural or black painted oak or in natural painted Canaletto walnut. Backrest and seat cushion with removable upholstery, made of polyurethane and self-shaping polyurethane foam respectively. Removable cover in fabric or leather.

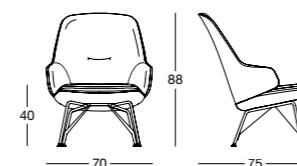
**Petit fauteuil**

Pieds en acier vernis graphite ou noir. Assise en polyuréthane rigide avec rembourrage de polyuréthane. Revêtement déhoussable en tissu ou en cuir. Dossier en hêtre plaqué dans la finition rouvre verni naturel, rouvre teinté noir ou plaqué en noyer Canaletto verni naturel. Rembourrage déhoussable du dossier et du coussin d'assise, respectivement en polyuréthane et en mousse de polyuréthane autoextinguible. Revêtement déhoussable en tissu ou en cuir.

Sessel

Beine aus schwarz oder graphit lackiertem Stahl. Sitzfläche aus steifem Polyurethan mit Polsterung aus Polyurethan. Abnehmbarer Bezug aus Stoff oder Leder. Rücken aus Buchensperrholz furniert mit naturfarben- oder schwarz lackierter Eiche, oder mit naturfarben lackiertem Nussbaum Canaletto. Abnehmbare Rücken- und Sitzkissen Polsterung, bzw. aus Polyurethan und aus selbstlöschendem Polyurethanschaum. Abnehmbarer Bezug aus Stoff oder Leder.

Butaquita

Patas de acero pintado grafito o negro. Asiento de poliuretano rígido con acolchado de poliuretano. Tapizado desenfundable de tejido o de piel. Respaldo en multicapa de haya enchapada de roble barnizado o pintado negro, o enchapado de nogal Canaletto barnizado natural. Acolchado respaldo y cojín asiento amovible, respectivamente de poliuretano y de espuma de poliuretano auto extintivo. Tapizado desenfundable en tejido o piel.

Gambe / Legs / Pieds / Beine / Patas**Schienale / Backrest / Dossier / Rücken / Respaldo**

Rovere naturale
Natural oakwood
Rouvre naturel
Naturfarbene Eiche
Roble natural

Noce Canaletto
Canaletto walnut
Noyer Canaletto
Nussbaum Canaletto/
Nogal Canaletto



Rovere tinto nero
Black varnished oak
Rouvre teinté noir
Schwarz-gebeizte Eiche
Roble teñido negro

888

Gilda CMOmaggio a Carlo Mollino
1953**Poltrona**

Struttura in rovere naturale o tinto nero oppure in noce Canaletto colore naturale; verniciatura con finitura a cera. Parti metalliche in ottone nichelsatinato colore nero. Schienale regolabile su quattro posizioni. Imbottitura in poliuretano /fibra poliester termolegata con molleggio su spirali d'acciaio. Rivestimento sfilabile in stoffa o in pelle.

Armchair

Frame in natural or black varnished oak, or in natural Canaletto walnut; wax-finished varnish. Black-nickel satin finished brass metal components. Four-position adjustable backrest. Upholstery in polyurethane/heat-bound polyester fibre with suspension on steel springs. Removable fabric or leather cover.

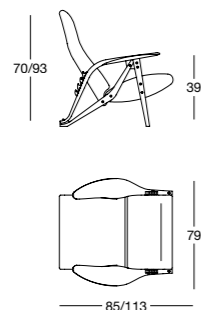
**Fauteuil**

Structure en rouvre naturel ou teinté noir ou en noyer Canaletto, couleur naturelle; verni finition cirée. Quincaillerie en laiton nickel satiné couleur noire. Dossier réglable sur quatre positions. Rembourrage en polyuréthane/fibre de polyester liée à chaud avec suspension à spirales d'acier. Revêtement déhoussable en tissu ou en cuir.

Sessel

Gestell aus naturfarbener oder schwarz lackierter Eiche, oder aus naturfarbenem Nussbaum Canaletto; Lackierung mit Wachs-Endbehandlung. Metallteilen aus Messing mit schwarz-vernichelter und mattierter Ausführung. Rückenlehne in vier Positionen verstellbar. Polsterung aus Polyurethan/wärmegebundener Polyesterfaser mit Federung auf Stahlfedern. Abnehmbarer Bezug aus Stoff oder Leder.

Butaca

Estructura de roble natural o teñido negro o de nogal Canaletto color natural; pintura con acabado de cera. Herrajes de latón niquelado color mate negro. Respaldo regulable en cuatro posiciones. Acolchado de poliuretano/fibra de poliéster termounida con suspensión de espirales de acero. Tapizado desenfundable de tejido o de piel.

Struttura / Frame / Structure / Gestell / Estructura

Rovere naturale
Natural oakwood
Rouvre naturel
Naturfarbene Eiche
Roble natural

Noce Canaletto
Canaletto walnut
Noyer Canaletto
Nussbaum Canaletto/
Nogal Canaletto



Rovere tinto nero
Black varnished oak
Rouvre teinté noir
Schwarz-gebeizte Eiche
Roble teñido negro

895

KentLudovica+Roberto Palomba
2013**Poltroncina**

Base girevole in acciaio verniciato, colore cromo, nero o grafite. Struttura in acciaio. Imbottitura in poliuretano/fibra poliester termolegata. Rivestimento sfilabile in stoffa o in pelle.

Armchair

Revolving base in varnished steel, colours: black, chrome or graphite. Steel frame. Upholstery in polyurethane/heat-bound polyester fibre. Removable fabric or leather cover.

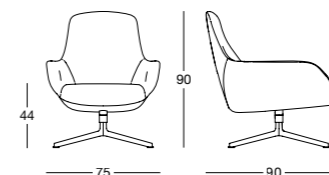
**Petit fauteuil**

Piètement pivotant en acier verni, couleur chrome, noire ou graphite. Structure en acier. Rembourrage de polyuréthane/fibre polyester liée à chaud. Revêtement déhoussable en tissu ou en cuir.

Kleiner Sessel

Drehbarer Stahlsockel, chrom, graphitfarben oder schwarz lackiert. Stahlgestell. Polsterung aus Polyurethan/wärmegebundener Polyesterfaser. Abnehmbarer Bezug aus Stoff oder Leder.

Butaquita

Base giratoria de acero barnizado, color cromo, negro o grafito. Estructura de acero. Acolchado de poliuretano/fibra poliéster termounida. Tapizado desenfundable de tejido o de piel.

Base / Base / Piètement / Sockel / Base

896
Kent
Ludovica+Roberto Palomba
2013

Poltrona / bergère. Pouf
Base girevole in acciaio verniciato, colore cromo, nero o grafite. Struttura in acciaio. Imbottitura in poliuretano/fibra poliestere termolegata. Rivestimento sfilabile in stoffa o in pelle.

Armchair / bergère. Pouf
Revolving base in varnished steel, colours: black, chrome or graphite. Steel frame. Upholstery in polyurethane/heat-bound polyester fibre. Removable fabric or leather cover.

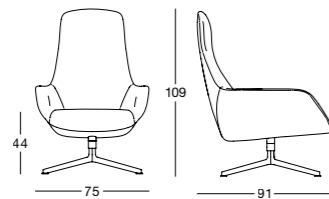

Fauteuil / bergère. Pouf
Piètement pivotant en acier verni, couleur chrome, noire ou graphite. Structure en acier. Rembourrage de polyuréthane/fibre polyester liée à chaud. Revêtement déhoussable en tissu ou en cuir.

Sessel / bergère. Hocker
Drehbarer Stahlsockel, chrom, graphitfarben oder schwarz lackiert. Stahlgestell. Polsterung aus Polyurethan/wärmegebundener Polyesterfaser. Abnehmbarer Bezug aus Stoff oder Leder.

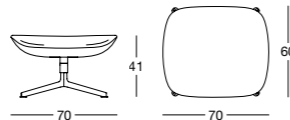

Butaca / bergère. Puf
Base giratoria de acero barnizado, color cromo, negro o grafito. Estructura de acero. Acolchado de poliuretano/fibra poliéster termounida. Tapizado desenfundable de tejido o de piel.

Base / Base / Piètement / Sockel / Base



921
Lama
Ludovica+Roberto Palomba
2006

Chaise longue
Struttura in acciaio verniciato, colore grafite. Imbottitura in poliuretano con molleggio su nastri elastici. Rivestimento sfilabile in stoffa o pelle, o non sfilabile in cuoio.

Chaise longue
Graphite varnished steel frame. Polyurethane upholstery with elastic strips suspension. Removable cover in fabric or leather, or non-removable in cowhide.

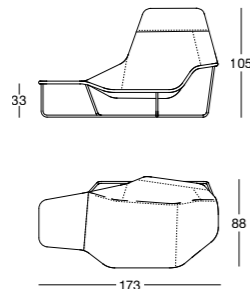

Chaise longue
Structure en acier verni, couleur graphite. Rembourrage de polyuréthane avec suspensions sur sangles élastiques. Revêtement déhoussable en tissu ou cuir, ou pas déhoussable en cuir sellier.

Chaiselongue
Lackiertes Stahlgestell, Graphitfarben. Polsterung aus Polyurethan auf elastischen Gurten. Abnehmbarer Bezug aus Stoff oder Leder, oder nicht abnehmbar aus Kernleder.

Sillón
Estructura de acero pintado color grafite. Acolchado de poliuretano sobre cintas elásticas. Tapizado desenfundable en tejido o piel, o non desenfundable en cuero.

887
Louise
Philippe Nigro
2018

Poltroncina
Struttura in legno massello di faggio laccato nei colori nero o bordeaux. Sedile e schienale in multistrato di pioppo con imbottitura in poliuretano. Rivestimento sfilabile in stoffa o pelle.

Armchair
Solid beech frame, lacquered in the shades black or burgundy. Seat and backrest made of poplar multilayer with polyurethane upholstery. Removable cover in fabric or leather.

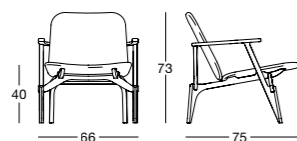

Petit fauteuil
Structure en bois de hêtre massif laqué dans les couleurs noir ou rouge bordeaux. Assise et dossier en contreplaqué de peuplier avec rembourrage en polyuréthane. Revêtement déhoussable en tissu ou cuir.

Sessel
Gestell aus massivem Buche, schwarz oder burgunderrot lackiert. Sitz und Rücken aus Pappel-Sperrholz mit Polsterung aus Polyurethan. Abnehmbarer Bezug aus Stoff oder Leder.

Butaca
Estructura de haya maciza pintada de color negro o granate. Asiento y respaldo contrachapado de álamo acolchado en poliuretano. Tapizado desenfundable de tejido o de piel.

Struttura / Frame / Structure / Gestell / Estructura



900
Maggiolina
Marco Zanuso
1947

Chaise longue
Struttura in acciaio inox lucidato, o nichelatinato colore naturale o nero, oppure verniciato nero. Scocca in cuoio pigmentato 90. Imbottitura cuscino schienale in piuma d'oca. Imbottitura cuscino seduta in poliuretano/Dacron Du Pont. Rivestimento, cuscini e braccioli in Ecofire o pelle.

Lounge chair
Polished or black painted steel tubular frame, or with natural or black nickel-satin finish. Sling in cowhide pigmentato 90. Back cushion in new goose feathers. Seat cushion upholstered in polyurethane/Dacron Du Pont. Cushions and armrests covered with Ecofire or leather.

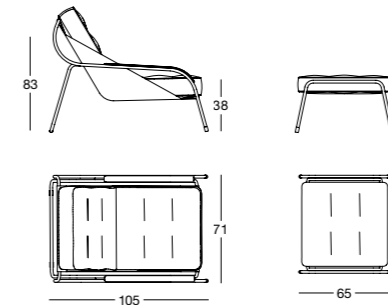

Chaise longue
Structure en acier inox poli, nickel satiné dans les finitions naturelle ou noire, ou verni couleur noire. Support en cuir sellier pigmentato 90. Coussin dossier en plume d'oie. Coussin assise en polyuréthane/Dacron Du Pont. Revêtement, coussins et accoudoirs en Ecofire ou cuir.

Chaiselongue
Gestell aus poliertem, oder schwarz lackiertem Inox-Stahl oder mit naturfarben- oder schwarz-vernicheltem und mattiertem Finish. Tragschale aus Kernleder pigmentato 90. Rückenkissen gefüllt mit reinen Gänsefedern. Sitzkissen aus Polyurethan/Dacron Du Pont. Kissen- und Armlehnen-Bezug aus Ecofire oder Leder.

Sillón
Estructura de acero inox pulido o niquelado mate en los acabados natural o negro, o pintado de color negro. Soporte para los cojines de cuero pigmentato 90. Cojín respaldo acolchado de plumas de ganso. Cojín asiento acolchado de poliuretano/Dacron Du Pont. Tapizado cojines y apoyabrazos de Ecofire o piel.

Struttura / Frame / Structure / Gestell / Estructura



851
Moretta
Bernard Marstaller
1917

Poltroncina disarticolata smontabile
Struttura in faggio, colore naturale. Schienale inclinabile. Rivestimento sfilabile in Telastrong o in cuoio.

Demountable armchair with supple joints
Natural beech frame. Tilting back. Removable cover in Telastrong or cowhide.

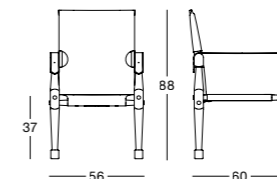

Petit fauteuil désarticulé démontable
Structure en hêtre, couleur naturelle. Dossier inclinable. Revêtement déhoussable en Telastrong ou en cuir sellier.

Sich den bodenebenenheiten anpassender zerlegbarer Stuhl
Gestell aus Buche, naturfarben. Schräg verstellbare Rückenlehne. Abnehmbarer Bezug aus Telastrong oder aus Kernleder.

Butaquita articulada desmontable
Estructura de haya, color natural. Respaldo abatible. Tapizado desenfundable en Telastrong o en cuero.

883
Oliva
Constance Guisset
2019

Poltroncina
Gambe in legno massello di acero laccato nei colori nero o grigio cenere. Struttura in acciaio. Imbottitura in poliuretano/fibra poliestere termolegata. Rivestimento sfilabile in stoffa o pelle.

Armchair
Legs in solid maple wood, lacquered in the shades black or ash grey. Steel frame. Upholstery with polyurethane/heat-bound polyester fibre. Removable cover in fabric or leather.

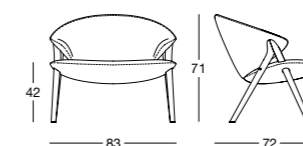

Petit fauteuil
Pieds en bois massif d'érable laqué dans les couleurs noir ou gris cendre. Structure en acier. Rembourrage de polyuréthane/fibre de polyester liée à chaud. Revêtement déhoussable en tissu ou en cuir.

Sessel
Beine aus massivem Ahornholz, lackiert in den Farben schwarz oder aschengrau. Stahl- Gestell. Polsterung aus Polyurethan/wärmegebundener Polyesterfaser. Abnehmbarer Bezug aus Stoff woder Leder.

Butaquita
Patas de madera maciza de arce lacada en los colores negro o gris ceniza. Estructura de acero. Acolchado de poliuretano/fibra poliéster termounida. Tapizado desenfundable de tejido o de piel.

Gambe / Legs / Pieds / Beine / Patas



926
Rider
 Ludovica+Roberto Palomba
 2020

Chaise longue basculante
 Struttura in poliuretano rigido con imbottitura in poliuretano a quote differenziate. Rivestimento struttura in cuoio 95. Trapuntino amovibile in poliuretano/fibra poliestere termolegata rivestito in tessuto. A richiesta è disponibile un poggiatesta con imbottitura in poliuretano/fibra poliestere termolegata rivestito in tessuto sfoderabile.

Tilting chaise longue
 Stiff polyurethane frame with upholstery in graduated polyurethane. Frame covered with cowhide 95. Removable topper made of polyurethane/heat-bound polyester fibre, covered with fabric. Upon request one headrest cushion upholstered with polyurethane/heat-bound polyester fibre, covered with removable fabric, is available.

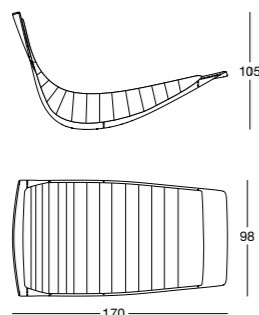

Chaise longue basculant
 Structure en polyuréthane rigide avec rembourrage en polyuréthane à densité variable, recouverte en cuir sellier 95. Topper amovible en polyuréthane/ fibre polyester liée à chaud recouvert en tissu. Un appui-tête avec rembourrage en polyuréthane/fibre polyester liée à chaud recouvert en tissu déhoussable, est disponible sur demande.

Schaukel-Chaiselongue
 Gestell aus steifem Polyurethan mit Polsterung aus Polyurethan in unterschiedlicher Dichte. Gestell bezogen mit Kernleder 95. Abnehmbares Topper aus Polyurethan/ wärmegebundener Polyesterfaser mit Stoff-Bezug. Auf Nachfrage ist ein Kopfkissen lieferbar, das mit Polyurethan/ wärmegebundener Polyesterfaser gepolstert und mit abnehmbarem Stoff-Bezug ist.

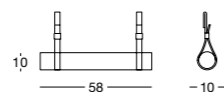

Chaise longue basculante
 Estructura de poliuretano rigido con acolchado de poliuretano a densidades diferenciadas. Tapizado de la estructura en cuero 95. Topper retirable de poliuretano/fibra poliéster termounida tapizado en tejido. Sobre pedido es disponible un cojin apoyacabeza acolchado de poliuretano/fibra poliéster termounida tapizado en tejido desenfundable.

278 / 279 / 280
Sacco Small
Sacco Medium
Sacco
 Gatti, Paolini, Teodoro
 1968

IN / OUT

Poltrone anatomiche
 Involucro contenente palline di polistirolo espanso ad alta resistenza. Rivestimento in Vip (anche per esterni, resistente al fuoco, antibatterico con trattamento Silverguard® e antimacchia con trattamento Permablock 3®), Tulip, Pied de poule e pelle. Le versioni in Tulip e Pied de poule sono sfoderabili.

Anatomical easy-chairs
 Envelope containing highly resistant expanded polystyrene pellets. Cover in: Vip (also for outdoor, fire-resistant, antibacterial with Silverguard® and stain-proof with Permablock 3® treatment), Tulip, Pied de poule and leather. The versions in Tulip and Pied de poule are removable.

Fauteuils anatomiques
 Housse contenant de petites billes de polystyrène à grande résistance. Revêtement en: Vip (aussi pour extérieurs, résistant au feu, antibactérien avec traitement Silverguard® et antitache avec traitement Permablock 3®), Tulip, Pied de poule et cuir. Les versions en Tulip et Pied de poule sont déhoussables.

Anatomische Sessel
 Hülle mit aufgeschäumten Polystyrol-Kügelchen gefüllt, widerstandsfähig. Bezug aus: Vip (auch fürs Freie, feuerbeständig, anti-bakteriell mit Behandlung Silverguard® und Fleckenschutz mit Behandlung Permablock 3®), Tulip, Pied de poule und Leder. Die Bezüge aus Tulip und Pied de poule sind abnehmbar.

Butacas anatómicas
 Bolsa rellena de bolitas de poliestirol expanso de alta resistencia. Tapizado en: Vip (tambien para exteriores, resistente al fuego, antibacteriano con tratamiento Silverguard® y antimancha con tratamiento Permablock 3®), Tulip, Pied de poule y piel. Las versiones en Tulip y Pied de poule son desenfundables.

278 Sacco Small

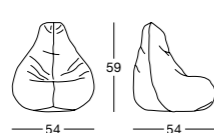

279 Sacco Medium

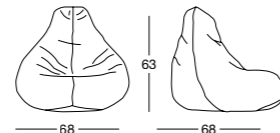

280 Sacco



850
Sant'Elia
 Giuseppe Terragni
 1936

Poltroncina
 Struttura in acciaio inox 18/8. Imbottitura in poliuretano. Rivestimento in pelle.

Armchair
 18/8 stainless steel frame. Polyurethane upholstery. Leather cover.

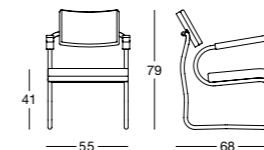

852
Susanna
 Gabriele Mucchi
 1983

Poltroncina
 Struttura portante in tubo di acciaio cromato, o nichel-satinato colore naturale o nero, oppure verniciato nero. Telaio porta-cuscini in acciaio verniciato nero, regolabile su due posizioni. Imbottitura cuscini in poliuretano/ fibra poliestere termolegata. Rivestimento cuscini sfilabile in stoffa o pelle. Nella versione con cuscini rivestiti in tessuto, i braccioli sono in pelle 95.

Armchair
 Carrying frame in chromium-plated, or in natural or black nickel-satin finished, or black painted tubular steel. Adjustable two-position cushion support in black painted steel. Cushions upholstery in polyurethane/heat-bound polyester fibre. Removable cushions cover in fabric or leather. The model with fabric covered cushions features the armrests covered with leather 95.

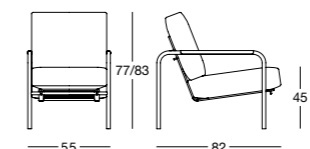

Petit fauteuil
 Structure en acier inox 18/8. Rembourrage en polyuréthane. Revêtement en cuir.

Armlehnstuhl
 Gestell aus Inox-Stahl 18/8. Polsterung aus Polyurethan. Bezug aus Leder.

Petit fauteuil
 Structure portante en tube d'acier chromé, ou nickel satiné, dans les finitions naturelle ou noire, ou verni noir. Châssis porte-coussins en acier verni noir, réglable sur deux positions. Rembourrage coussins en polyuréthane/fibre polyester liée à chaud. Revêtement coussins déhoussable en tissu ou cuir. Dans la version avec les coussins en tissu, les accoudoirs sont en cuir 95.

Sessel
 Gestell aus verchromtem oder schwarz-lackiertem Stahlrohr, oder mit naturfarben-oder schwarz-vernicheltem und mattiertem Finish. Kissenträger-Rahmen aus schwarz lackiertem Stahl, in zwei Positionen verstellbar. Polsterung der Kissen aus Polyurethan/ wärmegebundener Polyesterfaser. Abnehmbarer Kissen-Bezug aus Stoff oder Leder. Für die Version mit Stoff-bezogenen Kissen, sind die Armlehnen mit Leder 95.

Sillón
 Estructura de acero inox 18/8. Acolchado de poliuretano. Tapizado en piel.

Butaca
 Estructura tubular de acero cromado, o niquelado mate en los acabados natural o negro, o lacado negro. Bastidor porta-cojines de acero pintado de negro, regulable en dos posiciones. Acolchado de los cojines de poliuretano/fibra poliéster termounida. Tapizado desenfundable de los cojines de tejido o de piel. Por el modelo con cojines tapizados de tejido, los apoyabrazos están tapizados de piel 95.

Struttura / Frame / Structure / Gestell / Estructura



Tavolini, comodini, sottoconsolle
Small tables, night tables, benches
Petites tables, tables de chevet, banquettes
Beistelltische, Nachttische, Bänke
Mesitas, mesitas de noche, subconsolas

697
Arabesco CM
 Omaggio a Carlo Mollino
 1949

Tavolino
 Struttura in multistrati curvato, in rovere naturale o tinto nero; verniciatura con finitura a cera. La struttura è fissata al piano tramite bussole passanti. Piano superiore in cristallo temperato, piano inferiore in cristallo temperato, entrambi rispettivamente in cristallo extra-chiaro per la versione in rovere naturale o in cristallo fumé grigio per la versione in rovere tinto nero.

Small table
 Bent plywood frame in natural or black varnished oak; wax-finished varnish. The frame is attached to the top with an internally threaded screw. Top shelf in tempered plate glass; bottom shelf in tempered plate glass, both either extra-clear, matching the frames in natural oak or in smoky grey plate glass, matching the black varnished oak frame.

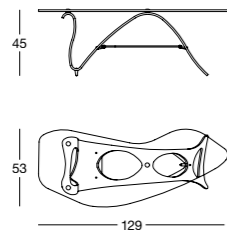

Petite table
 Structure en contreplaqué courbé, plaqué en rovere naturel ou teinté noir; verni finition cirée. La structure est fixée au plateau avec des traversées. Plateau supérieur en verre trempé, les deux respectivement en verre extra-clair pour la version en rovere naturel ou en verre gris fumé pour la version en rovere teinté noir.



Couchtisch
 Gestell aus gebogenem Schichtholz, mit naturfarbener oder schwarz lackierter Eiche furniert; Lackierung mit Wachs-Endbehandlung. Das Gestell ist mittels Durchführungsbuchsen am Gestell verbunden. Obere Platte aus gehärtetem Kristallglas; untere Platte aus gehärtetem Kristallglas, beide entweder extra-klar für die Version aus naturfarbener Eiche oder grau rauchfarben für die Version aus schwarz lackierter Eiche.

Mesita
 Estructura en madera contrachapada curvada, aplacada en roble natural o teñido negro; pintura con acabado de cera. La estructura se fija al sobre con brújulas que pasan a través. Superficie superior en cristal templado; superficie inferior en cristal templado, ambos respectivamente en cristal extra-claro para la versión de roble natural o en cristal gris humo para la versión de roble teñido negro.

Struttura / Frame / Structure / Gestell / Estructura

| | |
|---|--|
|  |  |
| Rovere naturale Natural oakwood Rouvre naturel Naturfarbene Eiche Roble natural | Rovere tinto nero Black varnished oak Rouvre teinté noir Schwarz-gebeizte Eiche Roble teñido negro |

Piano / Top / Plateau / Platte / Sobre

| | |
|--|---|
|  |  |
| Cristallo extra-chiaro Extra-clear plate glass Verre extra-clair Extra-klares Kristallglas Cristal extra-claro | Cristallo fumé grigio Smoky grey plate glass Verre gris fumé Rauchfarbenes Kristallglas Cristal gris humo |

695
Butterfly
 Alexander Taylor
 Zanotta E&Y Co-Edition
 2006

Tavolino
 Struttura in multistrati curvato, impiallacciato in rovere naturale o tinto bianco o nero. Piano in cristallo temperato.

Small table
 Bent plywood frame, veneered with natural, white or black painted oak. Top in tempered plate glass.

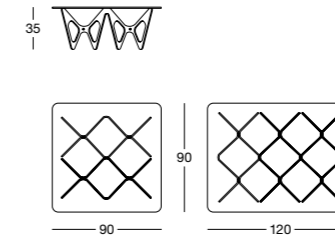



Petite table
 Structure en contreplaqué courbé, plaqué en rovere, couleur naturelle ou teinté blanc ou noir. Plateau en cristal trempé.

Beistelltisch
 Untergestell aus gebogenem Sperrholz, eichenfurniert, naturfarben, weiß oder schwarz lackiert. Platte aus gehärtetem Kristallglas.

Mesita
 Estructura con panel multiestrato curvado, contrachapado en roble natural, teñido blanco o negro. Sobre de cristal templado.

Struttura / Frame / Structure / Gestell / Estructura

| | |
|---|---|
|  |  |
| Rovere tinto bianco White varnished oak Rouvre teinté blanc Weiß-gebeizte Eiche Roble teñido blanco | Rovere naturale Natural oakwood Rouvre naturel Naturfarbene Eiche Roble natural |



Rovere tinto nero
Black varnished oak
Rouvre teinté noir
Schwarz-gebeizte Eiche
Roble teñido negro

638
Basello
 Achille Castiglioni
 1987

Tavolino a doppia altezza ad apertura variabile
 Struttura in medium density fiberboard, verniciatura gofrata antigraffio nei colori bianco, nero o bordeaux. Snodo in acciaio verniciato nero nelle versioni nera o bordeaux oppure bianco nella versione bianca.

Double height small table with variable spread
 Frame in medium density fiberboard finished with scratch resistant embossing in the shades white, black or burgundy. Steel articulated joint in the shade black for the models black or burgundy, or in the shade white for the white model.

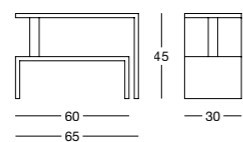



Petite table à deux hauteurs et ouverture variable
 Structure en medium density fiberboard, vernie antirayures dans les couleurs blanche, noire ou bordeaux. Articulation en acier verni noir dans les versions noire ou bordeaux ou verni blanc pour la version blanche.



Zweiteiliger verstellbarer Couchtisch
 Gestell aus Medium Density Fiberboard mit Anti-Kratzer-Lackierung, in den Farben weiß, schwarz oder burgunderrot. Verbindungsstück aus schwarz-lackiertem Stahl für die Modelle in den Farben schwarz oder burgunderrot; oder weiß lackiert für die weiße Version.

Mesita de doble altura y apertura variable
 Estructura en medium density fiberboard, laca en relieve anti-rasguño en los colores blanco, negro o burdeos. Articulación de acero pintado negro por las versiones en negro o burdeos, o blanco por la versión en blanco.

**Verniciatura gofrata / Embossed paint
 Vernissage gaufré / Gaufrierte Lackierung
 Lacadura anti-rasguño**

| | | |
|---|---|---|
|  |  |  |
|---|---|---|

**Snodo/Articulated joint / Articulation
 Verbindungsstück/Articulación**

| | |
|---|---|
|  |  |
|---|---|

335
Carlino CM
 Omaggio a Carlo Mollino
 1938

Contenitore di servizio
 Struttura e cassetto in legno verniciato nei colori bianco e nero. Pianetto d'appoggio in cristallo nei medesimi colori.

Service storage unit
 Frame and drawer in painted wood, in the shades black and white. Plate glass top in the same colours.





Petit meuble d'appoint
 Structure et tiroir en bois peint couleur noir et blanc. Tablette d'appui en verre dans les mêmes couleurs.

Service-Behälter
 Gestell und Schublade aus lackiertem Holz, in den Farben weiß und schwarz. Platte aus Kristallglas in den gleichen Farben.

Mueble de apoyo
 Estructura y cajón de madera lacada en los colores blanco y negro. Superficie de apoyo en cristal en los mismos colores.

Struttura / Frame / Structure / Gestell / Estructura

| | |
|---|---|
|  |  |
|---|---|

630
Cumano
 Achille Castiglioni
 1978

Tavolino pieghevole
 Struttura e piano in acciaio, colore nero, bianco, amaranto, antracite, corallo, mostarda, azzurro acqua. Giunto scorrevole in ABS.

Folding table
 Steel frame and top. Colours: black, white, amaranth, anthracite, coral, mustard, light blue. ABS sliding joint.

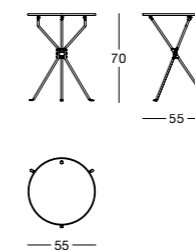

Petite table pliante
 Structure et plateau en acier, dans les couleurs noire, blanc, rouge amarante, anthracite, rouge corail, moutarde, bleu mer. Joint coulissant en ABS.

Klapptisch
 Gestell und Platte aus Stahl in den Farben schwarz, weiß, Anthrazit, Amaranth, Senfbraun, Hellblau und Korallenrot. Verschiebbares Gelenk aus ABS.

Mesita plegable
 Estructura y sobre de acero, en los colores: negro, blanco, granate, antracita, coral, mostaza, azul agua. Anilla corredera en ABS.

| | | | |
|---|---|---|---|
|  |  |  |  |
|  |  |  |  |

667
Echino
 Sebastian Herkner
 2019

Tavolino
 Gambe in vetro soffiato a tre strati nei colori fumè, azzurro, ambrà o blu. Piani in lamiera di acciaio nichel-satinati colore naturale o nero oppure in cristallo a specchio.

Small table
 Three-layered blown glass legs in the shades smoky grey, light-blue, amber or blue. Steel sheet top with either natural or black nickel-satin finish, or mirror top.

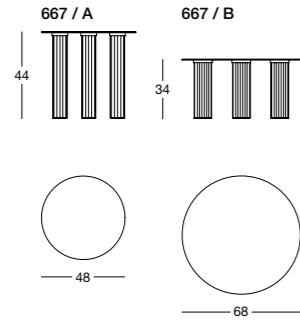

Petit table
 Pieds en verre soufflé à trois couches dans les couleurs gris-fumé, bleu clair, ambre ou bleu. Plateau en tôle d'acier dans les finitions nickel satiné naturel, ou nickel satiné noir, ou en miroir.

Beistelltisch
 Beine aus dreischicht-geblasenem Glas in den Farben rauchgrau, hellblau, Bernstein oder blau. Platten aus Stahlblech mit naturfarben oder schwarz vernickeltem Finish oder aus Spiegel-Kristallglas.

Mesita
 Patas de vidrio soplado de tres capas en color gris ahumado, azul claro, ámbar o azul. Sobre de chapa de acero en los acabados níquel satinado natural, o níquel satinado negro, o en espejo.



635
Girò
 Anna Deplano
 1997-1999

Tavolino con rotelle
 Struttura in acciaio verniciato, colore alluminio. Pianetti in laminato plastico stratificato, colore bianco.

Castor-mounted table
 Aluminium- painted steel frame. Shelves in layered plastic laminate in white.

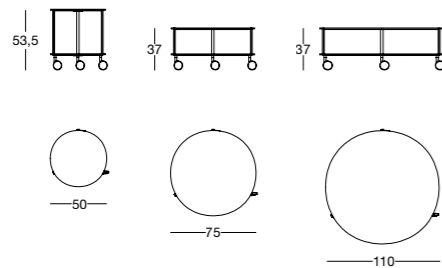

Petite table avec roulette
 Structure en acier verni, couleur aluminium. Plateaux en laminé plastique stratifié, couleur blanc.

Tischchen mit Rollen
 Gestell aus alufarben lackiertem Stahl. Platten aus massivem weißem Plastiklaminat.

Mesita con ruedas
 Estructura de acero pintado de color aluminio. Repisas de laminado plástico estratificado, de color blanco.

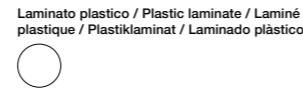

681 / 682
Graphium
 Garcia Cumini
 2019

Tavolini
 Struttura in acciaio verniciato colore bianco o nero. Piani in marmo Calacatta grigio, in marmo rosso Lepanto o in marmo Sahara Noir con verniciatura protettiva antimacchia, in poliester trasparente opaco.

Small tables
 Black or white varnished steel frame. Tops available either in grey Calacatta marble, in red Lepanto marble or in Sahara Noir marble with stain-resistant protective varnish, in clear matt polyester.

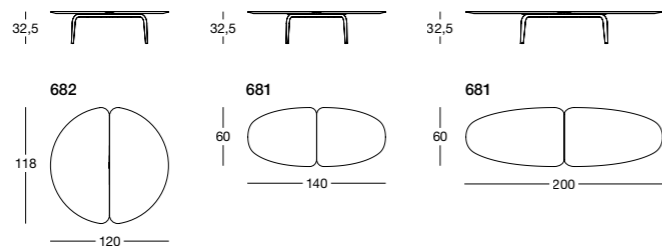

Petites tables
 Structure en acier verni blanc ou noir. Plateaux en marbre Calacatta gris, en marbre rouge Lepanto ou en marbre Sahara Noir avec peinture de protection anti taches en polyester transparent opaque.

Couchtische
 Gestell aus weiß oder schwarz lackiertem Stahl. Platten aus graufarbenem Calacatta Marmor, oder aus rotem Lepanto Marmor oder aus Sahara Noir Marmor mit Fleckenschutz Lackierung aus klarem mattem Polyester.

Mesitas
 Estructura en acero pintado color blanco o negro. Sobres de mármol Calacatta gris, de mármol Lepanto rojo o de mármol Sahara Noir con laca de protección antimancha en poliéster opaco transparente.

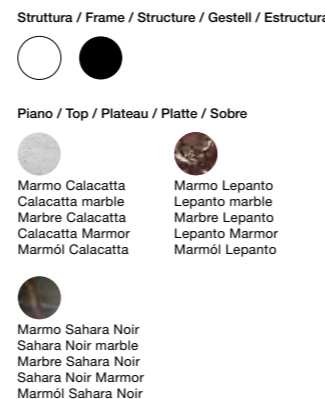

653 / 654
Loto
Ninfea
 Ludovica+Roberto Palomba
 2009

IN / OUT

Tavolini
 Piano e gambe in Cristalplant outdoor®, materiale composito a base di resine poliestere e acriliche cariche di minerali, pigmentato in massa colore bianco opaco, adatto anche per esterni.

Small tables
 Top and legs in Cristalplant outdoor®, composite material based on polyester and acrylic resins loaded with minerals and mass pigmented in the shade of matt white. Ideal also for outdoor use.

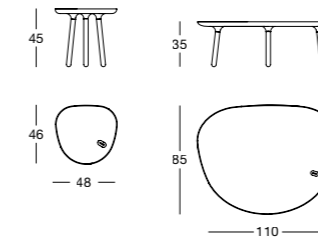

Petites tables
 Plateau et pieds en Cristalplant outdoor®, matériau composite à base de résines de polyester et acryliques riches en minéraux, pigmenté dans la masse, couleur blanc mat, adapté aussi pour l'extérieur.

Beistelltische
 Tischplatte und Beine aus Cristalplant outdoor®, weißopak maßenpigmentiertem, mineralhaltigem Polyesterharz- und Acryl Kompositmaterial, auch fürs Freie geeignet.

Mesitas
 Sobre y patas de Cristalplant outdoor®, material compuesto a base de resinas de poliéster y acrílicas cargadas de minerales, pigmentado en masa de color blanco opaco, adecuado también para exteriores.

648 / 671 / 672
Niobe
 Federica Capitani
 2016

Tavolini
 Struttura in acciaio verniciato colore bianco o nero. Piani in marmo bianco di Carrara, in marmo nero Marquinia o in marmo Emperador, con verniciatura protettiva antimacchia, in poliester trasparente opaco.

Small tables
 Steel frame painted in the shades black or white. Tops available either in white Carrara marble, in black Marquinia marble or in Emperador marble, with stain resistant protective varnish, in clear matt polyester.

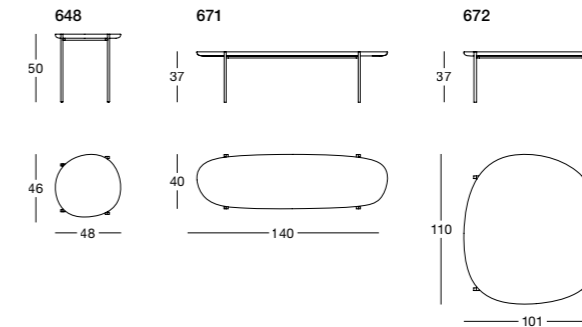

Petites tables
 Structure en acier verni blanc ou noir. Plateaux en marbre blanc de Carrare, en marbre noir Marquinia ou en marbre Emperador, avec vernis de protection anti taches de polyester transparent mat.

Beistelltische
 Gestell aus weiß oder schwarz lackiertem Stahl. Platten aus weißem Carrara Marmor, oder aus schwarzem Marquinia Marmor oder aus Emperador Marmor, mit Fleckenschutz Lackierung aus klarem mattem Polyester.

Mesitas
 Estructura de acero pintado blanco o negro. Sobres en mármol blanco de Carrara, en mármol negro Marquinia o en mármol Emperador, con laca de protección anti mancha, en poliéster mate transparente.



642
Oscar
 Emaf Progetti
 2005

Comodino con cassetto
 Struttura in acciaio verniciato colore grafite. Maniglia in alluminio verniciato colore grafite. Cassetto in medium density fiberboard impiallacciato in rovere naturale, tinto grigio o bianco.

Night table with drawer
 Graphite painted steel frame. Handle in graphite painted aluminium. Drawer in medium density fiberboard veneered with natural oak or varnished grey or white.

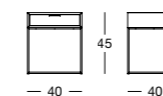

Table de chevet avec tiroir
 Structure en acier verni couleur graphite. Poignée en aluminium verni couleur graphite. Tiroir en medium density fiberboard, contreplaqué en rovere naturel, teinté gris ou blanc.

Nachttisch mit Schublade
 Gestell aus Graphit lackiertem Stahl. Griff aus Graphit lackiertem Aluminium. Schublade aus medium density fiberboard mit Eichenfurnier, naturfarben, grau oder weiß gebeizt.

Mesita de noche con cajón
 Estructura de acero pintado grafito. Manecilla de aluminio pintado color grafito. Cajón de medium density fiberboard enchapado de roble natural, teñido gris o blanco.



710
Quaderna
Superstudio
1970

Tavolino
Struttura in legno tamburato
placcato in laminato Print, colore
bianco, a stampa digitale a quadretti
neri con interasse di 3 cm.

Small table
Honeycomb core frame coated with
white plastic laminate, digitally
printed with black squares at 3 cm
spacing.

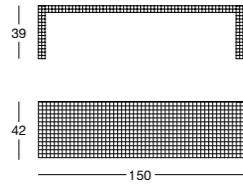

Petite table
Structure en panneau alvéolaire
plaqué en Print, couleur blanche,
imprimé en digital à carrés noirs
avec entraxe de 3 cm.

Beistelltisch
Gestell aus Sperrholz mit weißem
Print belegt. Digitaldruck mit
kariertem Muster, Linienabstand 3 cm.

Mesita
Estructura de madera aplacada
con laminado Print, color blanco,
a impresión digital en cuadros
negros de 3 cm.

360
Servomuto
Achille Castiglioni
della serie Servi
di Achille & Pier Giacomo
Castiglioni
1974

Tavolino di servizio
Base in polipropilene e asta in
acciaio verniciato colore nero, bianco
o amaranto. Pianetto in laminato
plastico stratificato, colore bianco/
nero, amaranto/grigio, cotto/avio.

Service table
Base in polypropylene and steel
rod painted, colour black, white
or amaranth. Top in white/black,
amaranth/grey, terracotta/grey blue
plastic laminate.

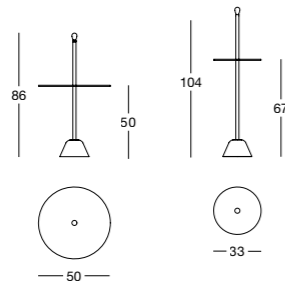

Table d'appoint
Base en polypropylène et tige en
acier peint en couleur noir, blanc ou
rouge amarante. Plateau en laminé
plastique stratifié, couleur blanc/noir,
rouge amarante/gris, terre cuite/bleu
pétrole.

Beistelltisch
Fuß aus Polypropylen und Stange
aus lackiertem Stahl, Farbe
schwarz, weiß oder amaranthrot.
Tischplatte aus massivem
Plastiklaminat, in den Farben weiß/
schwarz, Amaranthrot/grau, cotto/
fliegerblau.

Mesita de apoyo
Base de polipropileno y soporte de
acero pintado, color negro, blanco
o granate. Repisa de laminado
plástico estratificado, en los colores
blanco/negro, granate/gris, ocre/
azul verde.

Struttura / Frame / Structure / Gestell / Estructura



Pianetti / Shelves / Plateaux / Platten / Repisas



650
Sgabillo
Max Bill
1950

Sgabello
Struttura in multistrati di betulla
verniciata, colore naturale, o
in medium density fiberboard,
verniciatura gofrata antigraffio,
colore nero.

Stool
Structure in natural varnished,
layered birch or in black lacquered
medium density fiberboard finished
with scratch-resistant embossing.

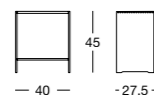

Tabouret
Structure en contreplaqué de
bouleau verni, couleur naturelle
ou en medium density fiberboard,
vernissage gaufré antirayures,
couleur noire.

Hocker
Gestell aus Birkenesperrholz,
naturfarben oder aus Medium
Density Fiberboard, gaufrierte Anti-
Kratzer-Lackierung, schwarz.

Taburete
Estructura de madera chapada de
abedul, barnizada de color natural o
de medium density fiberboard, laca
en relieve anti-rasguño, color negro.

Struttura / Frame / Structure / Gestell / Estructura



661
Spotty
Pierre Charpin
2019

Tavolini
Gambe in faggio laccate colore
nero. Piani in medium density
fiberboard placcati in laminato Print
serigrafato finitura "papier". Decoro
esclusivo in versione puntini neri su
fondo bianco o puntini bianchi su
fondo nero.

Small tables
Legs in black lacquered beech.
Medium density fiberboard top,
covered with silk-screened Print
laminate, with "papier" finish.
Exclusive decoration in two
versions: black dots on white top
or white dots on black top.

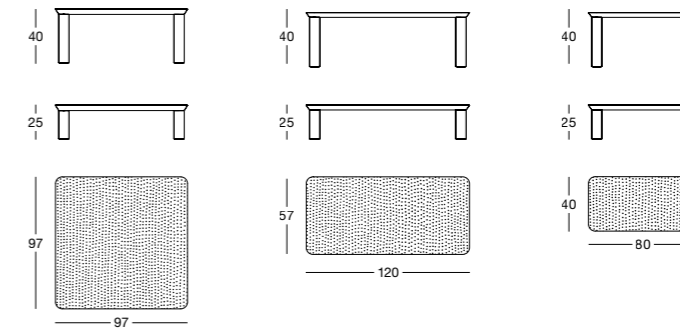

Petites tables
Pieds en hêtre laqué noir. Plateaux
en medium density fiberboard,
plaqués en laminé sérigraphié
Print, avec finition "papier".
Décoration exclusive à pois noirs sur
fond blanc ou blancs sur fond noir.

Couchtische
Beine aus schwarz lackierter Buche.
MDF Platten, mit Print Laminat
beschichtet, mit Siebdruck "papier"
Finish. Exclusive Dekoration in
zwei Versionen lieferbar: schwarze
Punkte auf weiße Platte oder weiße
Punkte auf schwarze Platte.

Mesitas
Patatas de haya lacada color
negro. Sobres de medium density
fiberboard, chapado de laminado
Print serigrafiado, con finitura
"papier". Decoración exclusiva en
puntos negros sobre fondo blanco o
puntos blancos sobre fondo negro.

643
Taschino
Gabriele Rosa
2017

Comodino con cassetto
Struttura e piano in acciaio
verniciato colore bianco, nero o
grafite. Piano e vano portaoggetti
in cuoio pigmentato 90. Il vano è
accessibile mediante apertura a
ribalta.

Nightstand with drawer
Top and frame in white, black
or graphite painted steel. Top
and storage space in cowhide
pigmentato 90. The storage is
accessed by a dropleaf opening.

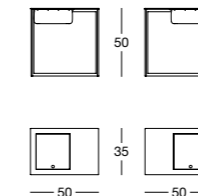

Table de chevet avec tiroir
Structure et plateau en acier verni
couleur blanche, noire ou graphite.
Plateau et élément porte-objets en
cuir sellier pigmentato 90. L'élément
est accessible par une ouverture
basculante.

Nachttisch mit Schublade
Gestell und Platte aus weiß-,
schwarz- oder graphitfarben-
lackiertem Stahl. Platte und
Ablagefach aus Kernleder
pigmentato 90. Das Ablagefach ist
mit Kippöffnung versehen.

Mesita de noche con cajón
Estructura y sobre de acero pintado
de color blanco, negro o grafito.
Sobre y compartimento portaobjetos
de cuero pigmentato 90. Se puede
acceder al compartimento mediante
apertura abatible.

Struttura / Frame / Structure / Gestell / Estructura



631
Tempo
Prospero Rasulo
2001

Tavolino-portaoggetti
Coni in poliuretano rigido, asta di
sostegno in acciaio, laccatura lucida
nei colori della cartella.

Small table / stand
Stiff polyurethane cones, steel stem,
glossy lacquer in the colours shown
on the colour card.

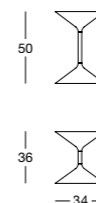

Table basse / porte-objets
Cônes en polyuréthane rigide, tige
de soutien en acier, laquage brillant
dans les couleurs de la fiche.

Tischchen / Ablage
Kegel aus steifem Polyurethan,
Trägerstange aus Stahl mit poliertem
Glanzack in den Farben der
Musterkarte.

Mesita / porta objetos
Conos de poliuretano rígido, asta
central de acero, lacados brillante
en los colores del muestrario.



6006

Teti
Prospero Rasulo
2006

IN / OUT

Tavolino

Struttura in gres fine porcellanato antigelivo per esterni, con doppia smaltatura manuale a spessore controllato, cotto a 1250°C con un ciclo di lavorazione di 36 ore, colore verde-giallo.

Occasional table

Freeze resistant frame in fine porcelainized grès for outdoors use with thickness controlled two-layering applied by hand and baked at 1250°C with a 36-hour processing cycle, colour green-yellow.

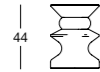

Petite table

Structure en grès fin émaillé résistante au gel pour externes, avec double émaillage manuel à épaisseur contrôlée, cuit à 1250°C en appliquant un cycle d'oeuvre de 36 heures, couleur vert-jaune.

Couchtisch

Gestell aus frostfestem und wetter-beständigem Feinsteinzeug, doppelte, dickenkontrollierte Handglasur, über 36 Stunden bei 1250 °C gebrannt, Farbe grün-gelb.

Mesita

Estructura de gres fino porcelánico antihielo para uso exterior, con doble capa de esmalte a mano de espesor controlado, cocido a 1250°C con un ciclo de elaboración de 36 horas, color verde-amarillo.

6005

Zeus
Prospero Rasulo
2006

IN / OUT

Tavolino

Struttura in gres fine porcellanato antigelivo per esterni, con doppia smaltatura manuale a spessore controllato, cotto a 1250°C con un ciclo di lavorazione di 36 ore, colore blu-marrone.

Occasional table

Freeze resistant frame in fine porcelainized grès for outdoors use with thickness controlled two-layering applied by hand and baked at 1250°C with a 36-hour processing cycle, colour blue-brown.

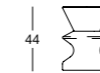

Petite table

Structure en grès fin émaillé résistante au gel pour externes, avec double émaillage manuel à épaisseur contrôlée, cuit à 1250°C en appliquant un cycle d'oeuvre de 36 heures, couleur bleu-brun.

Couchtisch

Gestell aus frostfestem und wetter-beständigem Feinsteinzeug, doppelte, dickenkontrollierte Handglasur, über 36 Stunden bei 1250 °C gebrannt, Farbe blau-braun.

Mesita

Estructura de gres fino porcelánico antihielo para uso exterior, con doble capa de esmalte a mano de espesor controlado, cocido a 1250°C con un ciclo de elaboración de 36 horas, color azul-marrón.

634

Tod
Todd Bracher
2005

Tavolino

Struttura in polipropilene, laccatura lucida nei colori della cartella.

Small table

Polypropylene frame and glossy lacquer finish in the colours shown on our colour card.

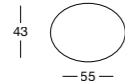
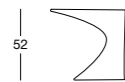

Petite table

Structure en polypropylène, laquage brillant dans les couleurs de la fiche.

Tischchen

Gestell aus Polypropylen, glanzlackiert in den Farben der Musterkarte.

Mesita

Estructura de polipropileno, lacado brillante en los colores del muestrario.



632

Toi
Salvatore Indriolo
2012

Tavolino

Struttura in poliuretano rigido. Piano in multistrato placcato alluminio. Verniciatura nei colori bianco, nero o rosso. Il piano superiore ruotando a 360° permette l'accesso ad un vano portaoggetti sottostante.

Small table

Stiff polyurethane frame. Aluminum-covered plywood top. Varnish in black, white or red. Organizer compartment revealed by rotating table top 360°.

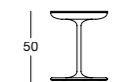

Petite table

Structure en polyurethane rigide. Plateau en multicouche plaqué aluminium. Peinture en blanche, noire ou rouge. Le plateau supérieur tourne à 360° et permet ainsi d'accéder à un espace porte-objets situé dessous.

Beistelltisch

Gestell aus steifem Polyurethan. Furnierholzplatte mit Aluminium beschichtet. Lackierung in den Farben weiß, schwarz oder rot. Die Platte lässt sich über einem darunterliegenden Staufach um 360° drehen.

Mesita

Estructura de poliuretano rígido. Sobre en multicapa chapado de aluminio. Lacado en color blanco, negro o rojo. Girando 360° el sobre superior se accede a un compartimento portaobjetos inferior.



Sedie, poltroncine, sgabelli
Chairs, small armchairs, stools
Chaises, petites fauteuils, tabourets
Stühle, Kleine Sessel, Hocker
Sillas, butaquitas, taburetes

2120
April
Gae Aulenti
1964

IN / OUT

Sedia pieghevole per interni ed imbarcazioni
Struttura in acciaio inox. Snodi in lega di alluminio. Rivestimento sfilabile in Vip (per esterni), in Telastrong o in cuoio 95.

Folding chair for indoors and boats

Stainless steel frame. Aluminum alloy joints. Removable cover in Vip (for outdoors), in Telastrong, or in cowhide 95.

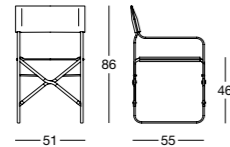

Chaise pliante pour intérieurs et embarcations
Structure en acier inox. Articulations en alliage d'aluminium. Revêtement déhoussable en Vip (pour extérieurs), en Telastrong, ou en cuir sellier 95.

Klappstuhl für Innenräume und Schiffe

Gestell aus Inox-Stahl. Gelenke aus Aluminiumlegierung. Abnehmbarer Bezug aus Vip (fürs Freie), aus Telastrong, oder aus Kernleder 95.

Silla plegable para interiores y barcos
Estructura de acero inox. Articulaciones de aleación de aluminio. Tapizado desenfundable de Vip (para exteriores), de Telastrong, o de cuero 95.

2260
Celestina
Marco Zanuso
1978

Sedia pieghevole
Struttura in acciaio verniciato, colore nero o bianco. Sedile e schienale in nylon ricoperti in cuoio 95.

Folding chair

Frame in black or white painted steel. Nylon seat and back covered in cowhide 95.

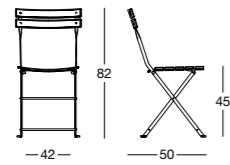

Chaise pliante
Structure en acier verni noir ou blanc. Assise et dossier en nylon recouverts de cuir sellier 95.

Klappstuhl

Gestell aus lackiertem Stahl, schwarz oder weiß. Sitzfläche und Rückenlehne aus Nylon mit Kernleder 95 bezogen.

Silla plegable
Estructura de acero pintado en los colores: negro o blanco. Asiento y respaldo de nylon tapizados de cuero 95.

Struttura / Frame / Structure / Gestell / Estructura



2059
Dan
Patrick Norguet
2020

Sedia
Struttura in acciaio verniciato colore grigio ferro o nero opaco. Seduta e schienale imbottiti in poliuretano. Rivestimento non sfilabile in cuoio 95.

Chair

Steel frame varnished iron grey or matt black. Seat and backrest upholstered with polyurethane. Non removable cover in cowhide 95.

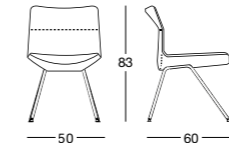

Chaise
Structure en acier verni gris fer ou noir mat. Siège et dossier rembourrés en polyuréthane. Revêtement pas déhoussable en cuir sellier 95.

Stuhl

Gestell aus eisengrauem oder mattem schwarz-lackierten Stahl. Sitz und Rückenlehne gepolstert mit Polyurethan. Nicht abnehmbarer Bezug aus Kernleder 95.

Silla
Estructura de acero pintado en los colores gris hierro o negro mate. Asiento y respaldo acolchados de poliuretano. Tapizado no desenfundable de cuero.

Struttura / Frame / Structure / Gestell / Estructura



2057 / 2058
Dan
Patrick Norguet
2020

Sedia con o senza braccioli
Struttura in acciaio verniciato colore grigio ferro o nero opaco. Seduta e schienale realizzati con nastri elastici in filato di poliestere nei colori giallo, corda, antracite e blu. Il logo Zanotta è stampato sulla prima cinghia della seduta e collocato sul lato destro. A richiesta è disponibile la personalizzazione di stampa delle cinghie.

Chair with or without armrests

Steel frame varnished iron grey or matt black. Seat and backrest made of elastic straps in polyester thread available in yellow, string, anthracite and blue. The Zanotta logo is printed on the first strap of the seat, on the right side. Upon request the customized writing on the straps is available.

Chaise avec ou sans accoudoirs
Structure en acier verni gris fer ou noir mat. Assise et dossier réalisés avec des rubans élastiques en fil de polyester dans les couleurs jaune, corde, anthracite et bleu. Le logo Zanotta est imprimé sur le premier ruban d'assise sur le côté droit. Sur demande est disponible une personnalisation de la presse des angles.

Stuhl mit oder ohne Armlehnen

Gestell aus eisengrauem oder mattem schwarz-lackierten Stahl. Sitz und Rückenlehne bestehen aus Gummibändern in Polyesterfaden in den Farben Gelb, Schnur, anthrazit und blau. Das Zanotta Logo ist auf das erste Band des Sitzens, an der rechten Seite, gedruckt. Auf Nachfrage können die Aufschriften auf die Bänder personalisiert werden.

Silla con o sin apoyabrazos
Estructura de acero pintado en los colores gris hierro o negro mate. Asiento y respaldo realizados con cintas elásticas de poliéster en los colores amarillo, cuerda, antracita y azul. El logo Zanotta está impreso en la primera cinta del asiento, y colocado en el lado derecho. Sobre pedido es disponible la personalización de la impresión de las cintas.

Struttura / Frame / Structure / Gestell / Estructura



Seduta / Seat / Siège / Sitz / Asiento



2051
Fenis CM
Omaggio a Carlo Mollino
1959

Sedia
Struttura in legno massello di acero verniciato colore naturale o nero.

Chair

Frame in natural or black painted solid maple wood.

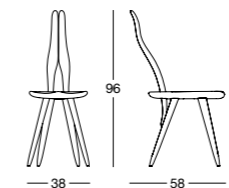

Chaise
Structure en érable massif verni couleur naturel ou noir.

Stuhl

Gestell aus massivem Ahornholz, naturfarben oder schwarz lackiert.

Silla
Estructura de madera de arce maciza con acabado en color natural o negro.

Struttura / Frame / Structure / Gestell / Estructura

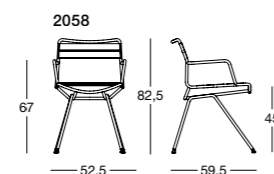
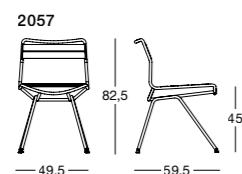

2286

Ido
Frank Rettenbacher
2016**Sgabelli**

Struttura in legno massello di rovere o noce Canaletto verniciati, colore naturale. Poggiapiedi in acciaio inox satinato.

Stools

Frame in solid oak or Canaletto walnut, natural painted. Footrest in satin-finished stainless steel.

2286/A 38 x 72 cm
2286/B 38 x 65 cm

2055 / 2056

June
Frank Rettenbacher
2016**Sedie**

Gambe in acciaio verniciato, colore bianco o nero. Sedile in nylon caricato fibra di vetro con imbottitura in poliuretano. Rivestimento sfilabile in stoffa o in pelle. Il rivestimento in tessuto è lavabile esclusivamente a secco. Schienale in multistrato di faggio placcato in rovere verniciato naturale o tinto nero oppure placcato in noce Canaletto verniciato colore naturale.

Chairs

Black or white painted steel legs. Nylon seat reinforced with glass fibre, with polyurethane upholstery. Removable cover in fabric or leather. The fabric cover can be exclusively dry cleaned. Backrest in beech plywood, covered with natural or black painted oak or in natural painted Canaletto walnut.

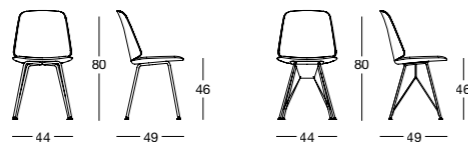
**Chaises**

Pieds en acier verni blanc ou noir. Siège en nylon renforcée de fibres de verre avec rembourrage en mousse de polyuréthane. Revêtement déhoussable en tissu ou en cuir. Le revêtement en tissu est lavable seulement à sec. Dossier en contreplaqué de hêtre plaqué en rovere verni naturel ou teinté noir ou plaqué en noyer Canaletto verni naturel.

Stühle

Beine aus schwarz oder weiß lackiertem Stahl. Sitzfläche aus Nylon mit Glasfaser verstärkt, und Polsterung aus Polyurethan. Abnehmbarer Bezug aus Stoff oder Leder. Der Stoff-Bezug kann exklusiv nur chemisch gereinigt werden. Rücken aus Buchensperrholz furniert mit naturfarben- oder schwarz lackierter Eiche, oder mit naturfarben lackiertem Nussbaum Canaletto.

Taburetes

Estructura de madera maciza de roble o nogal Canaletto, barnizados natural. Reposapiés de acero inox satinado.

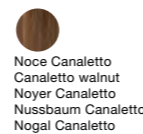
**Sillas**

Patas de acero pintado blanco o negro. Asiento de nylon reforzado con fibra de vidrio y acolchado de poliuretano. Tapizado desenfundable de tejido o de piel. El tapizado de tejido tiene que ser lavado exclusivamente en seco. Respaldo en multicapa de haya enchapada de roble barnizado natural o pintado negro, o enchapado de nogal Canaletto barnizado natural.

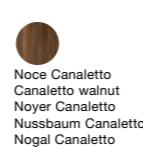
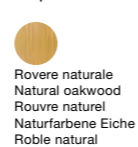
Gambe / Legs / Pieds / Beine / Patas**Schienale / Backrest / Dossier / Rücken / Respaldo**

2083 / 2084 / 2085

Lea
Roberto Barbieri
2003**Sedia. Poltroncina**

Struttura in lega di alluminio. Sedile, schienale e braccioli imbottiti in poliuretano. Rivestimento sfilabile in stoffa o in pelle oppure non sfilabile in cuoio. A richiesta viene fornita una fodera coprisedia da calzare senza fissare: in tessuto 100% cotone, colore bianco, disponibile sia corta che ricopre sedile e schienale, sia lunga che ricopre anche le gambe.

Chair. Armchair

Aluminium alloy frame. Seat, back and armrests upholstered in polyurethane. Removable cover in fabric or leather or non-removable in cowhide. Upon request one loose cover to be put on without fixing can be supplied: in 100% white cotton, available either short covering seat and backrest or long covering legs too.

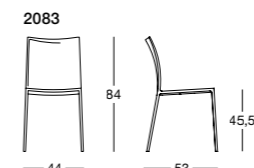
**Chaise. Petit fauteuil**

Structure en alliage d'aluminium. Siège, dossier et accoudoirs rembourrés en polyuréthane. Revêtement déhoussable en tissu ou en cuir ou pas déhoussable en cuir sellier. Sur demande on peut fournir une housse à poser sans la fixer pour protéger les chaises: en tissu 100% coton, couleur blanche, dans les versions courte qui couvre assise et dossier ou longue qui couvre même les pieds.

Stuhl. Armlehnstuhl

Gestell aus Alu-Legierung. Sitz, Rückenlehne und Armlehnen Polyurethan-gepolstert. Abnehmbarer Bezug aus Stoff oder Leder oder aus nicht abnehmbarem Kernleder. Auf Nachfrage ist ein loser Bezug verfügbar, der auf dem Stuhl ohne befestigen anzuziehen ist: aus 100% weißer Baumwolle, in zwei Versionen lieferbar, kurz, der Sitz und Rücken überzieht, oder lang, der auch die Beine überzieht.

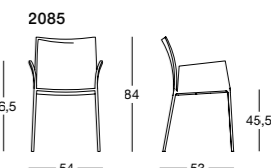
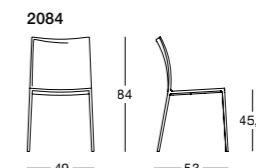
2081
Lealta
Roberto Barbieri
2006**Sedia**

Struttura in lega di alluminio. Sedile e schienale imbottiti in poliuretano. Rivestimento sfilabile in stoffa o in pelle oppure non sfilabile in cuoio. A richiesta viene fornita una fodera coprisedia da calzare senza fissare: in tessuto 100% cotone, colore bianco, disponibile sia corta che ricopre sedile e schienale, sia lunga che ricopre anche le gambe.

Chair

Aluminium alloy frame. Seat and back upholstered in polyurethane. Removable cover in fabric or leather or non-removable in cowhide. Upon request one loose cover to be put on without fixing can be supplied: in 100% white cotton, available either short covering seat and backrest or long covering legs too.

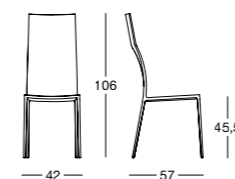
**Chaise**

Structure en alliage d'aluminium. Siège et dossier rembourrés en polyuréthane. Revêtement déhoussable en tissu ou en cuir ou pas déhoussable en cuir sellier. Sur demande on peut fournir une housse à poser sans la fixer pour protéger les chaises: en tissu 100% coton, couleur blanche, dans les versions courte qui couvre assise et dossier ou longue qui couvre même les pieds.

Stuhl

Gestell aus Aluminiumlegierung. Sitz und Rückenlehne Polyurethan-gepolstert. Abnehmbarer Bezug aus Stoff oder Leder oder aus nicht abnehmbarem Kernleder. Auf Nachfrage ist ein loser Bezug verfügbar, der auf dem Stuhl ohne befestigen anzuziehen ist: aus 100% weißer Baumwolle, in zwei Versionen lieferbar, kurz, der Sitz und Rücken überzieht, oder lang, der auch die Beine überzieht.

Silla

Estructura de aleación de aluminio. Asiento y respaldo acolchados en poliuretano. Tapizado desenfundable de tejido o de piel o no desenfundable de cuero. A pedido suministramos una funda de poner sobre la silla sin fijarla: de tejido 100% algodón, color blanco, disponible corta que cubre asiento y respaldo o larga que cubre también las patas.

2292 / 2291

Leo
Lio
 Roberto Barbieri
 2005

Sgabelli

Struttura in lega di alluminio (2292) oppure in lega di alluminio lucidato o verniciato colore nero, grafite o bianco (2291). Sedile e schienale imbottiti in poliuretano. Rivestimento sfilabile in stoffa o in pelle oppure non sfilabile in cuoio. Poggiapiedi in acciaio inox satinato. A richiesta viene fornita una fodera copri sgabello, in tessuto 100% cotone, colore bianco, da calzare senza fissare, che ricopre sedile e schienale.

Stools

Frame in aluminum alloy (2292) or in polished aluminum alloy, or painted black, graphite or white (2291). Seat and back with polyurethane upholstery. Removable cover in fabric or leather or non-removable in cowhide. Footrest in satin-finished stainless steel. Upon request a 100% white cotton loose stool cover to be put on without fixing, covering seat and backrest, can be supplied.

Tabourets

Structure en alliage d'aluminium (2292) ou en alliage d'aluminium poli, ou verni couleur noir, graphite ou blanche (2291). Assise et dossier rembourrés en polyuréthane. Revêtement déhoussable en tissu ou en cuir ou pas déhoussable en cuir sellier. Appuie-pieds en acier inox satiné. Sur demande on va fournir une housse qui protège le tabouret en tissu 100% coton, couleur blanche, de poser sans la fixer, qui couvre assise et dossier.

Hocker

Gestell aus Aluminiumlegierung (2292) oder aus polierter Aluminiumlegierung, oder schwarz, Graphit oder weiß lackiert (2291). Sitz und Rückenlehne mit Polsterung aus Polyurethan. Abnehmbarer Außenbezug aus Stoff oder Leder oder aus nicht abnehmbarem Kernleder. Fußstütze aus satiniertem Edelstahl. Auf Nachfrage ist ein loser Bezug aus 100% weißer Baumwolle lieferbar, der auf dem Hocker ohne Befestigen anzuziehen ist und Sitz und Rücken überzieht.

Taburetes

Estructura de aleación de aluminio (2292) o de aleación de aluminio pulido o barnizado color negro, grafite o blanco (2291). Asiento y respaldo acolchados de poliuretano. Tapizado desenfundable de tejido o de piel o no desenfundable de cuero. Reposapiés de acero inoxidable satinado. A pedido suministramos una funda que protege el taburete de tejido 100% algodón, color blanco, de poner sobre el taburete sin fijarla, que cubre asiento y respaldo.

Struttura / Frame / Structure / Gestell / Estructura (mod. 2291)

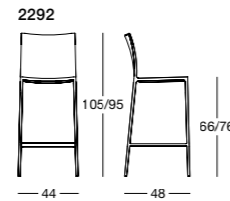
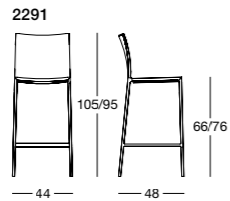
2291/A h 76 cm
2291/B h 66 cm2292/A h 76 cm
2292/B h 66 cm

2086 / 2087 / 2088

Lia
 Roberto Barbieri
 1998-1999

Sedia. Poltroncina

Struttura in lega di alluminio lucidato oppure verniciato, colore nero, grafite o bianco. Sedile, schienale e braccioli imbottiti in poliuretano. Rivestimento sfilabile in stoffa o in pelle oppure non sfilabile in cuoio. A richiesta viene fornita una fodera coprisedia da calzare senza fissare: in tessuto 100% cotone, colore bianco, disponibile sia corta che ricopre sedile e schienale, sia lunga che ricopre anche le gambe.

Chair. Armchair

Aluminum alloy frame, polished or painted black, graphite or white. Seat, back and armrests upholstered in polyurethane. Removable cover in fabric or leather or non-removable in cowhide. Upon request one loose cover to be put on without fixing can be supplied: in 100% white cotton, available either short covering seat and backrest or long covering legs too.

Chaise. Petit fauteuil

Structure en alliage d'aluminium poli ou verni, couleur noir, graphite ou blanc. Siège, dossier et accoudoirs rembourrés en polyuréthane. Revêtement déhoussable en tissu ou en cuir ou pas déhoussable en cuir sellier. Sur demande on peut fournir une housse à poser sans la fixer pour protéger les chaises: en tissu 100% coton, couleur blanche, dans les versions courte qui couvre assise et dossier ou longue qui couvre même les pieds.

Stuhl. Armlehnstuhl

Gestell aus polierter Aluminiumlegierung oder schwarz, Graphit oder weiß lackiert. Sitz, Rückenlehne und Armlehnen Polyurethan-gepolstert. Abnehmbarer Bezug aus Stoff oder Leder oder aus nicht abnehmbarem Kernleder. Auf Nachfrage ist ein loser Bezug verfügbar, der auf dem Stuhl ohne Befestigen anzuziehen ist: aus 100% weißer Baumwolle, in zwei Versionen lieferbar, kurz, der Sitz und Rücken überzieht, oder lang, der auch die Beine überzieht.

Silla. Sillón

Estructura de aleación de aluminio pulido o pintado de color negro, grafite o blanco. Asiento, respaldo y apoyabrazos acolchados en poliuretano. Tapizado desenfundable de tejido o de piel o no desenfundable de cuero. A pedido suministramos una funda de poner sobre la silla sin fijarla: de tejido 100% algodón, color blanco, disponible corta que cubre asiento y respaldo o larga que cubre también las patas.

Struttura / Frame / Structure / Gestell / Estructura

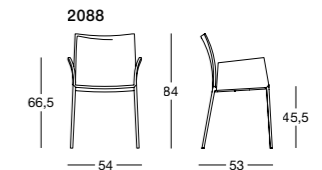
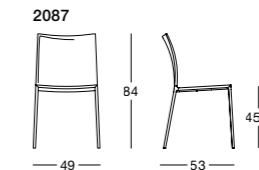
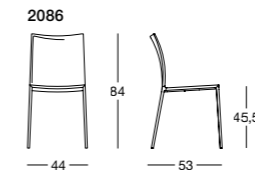

2086 / 2087 / 2088

Lia

2082
Lialta
 Roberto Barbieri
 2006

Sedia.

Struttura in lega di alluminio lucidato oppure verniciato colore nero, grafite o bianco. Sedile e schienale imbottiti in poliuretano. Rivestimento sfilabile in stoffa o in pelle oppure non sfilabile in cuoio. A richiesta viene fornita una fodera coprisedia da calzare senza fissare: in tessuto 100% cotone, colore bianco, disponibile sia corta che ricopre sedile e schienale, sia lunga che ricopre anche le gambe.

Chair

Aluminum alloy frame, polished or painted black, graphite or white. Seat and back upholstered in polyurethane. Removable cover in fabric or leather or non-removable in cowhide. Upon request one loose cover to be put on without fixing can be supplied: in 100% white cotton, available either short covering seat and backrest or long covering legs too.

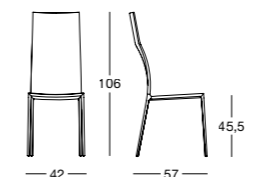
**Chaise**

Structure en alliage d'aluminium poli ou verni, couleur noir, graphite ou blanc. Siège et dossier rembourrés en polyuréthane. Revêtement déhoussable en tissu ou en cuir ou pas déhoussable en cuir sellier. Sur demande on peut fournir une housse à poser sans la fixer pour protéger les chaises: en tissu 100% coton, couleur blanche, dans les versions courte qui couvre assise et dossier ou longue qui couvre même les pieds.

Stuhl

Gestell aus polierter Aluminiumlegierung oder schwarz, Graphit oder weiß lackiert. Sitz und Rückenlehne Polyurethan-gepolstert. Abnehmbarer Bezug aus Stoff oder Leder oder aus nicht abnehmbarem Kernleder. Auf Nachfrage ist ein loser Bezug verfügbar, der auf dem Stuhl ohne Befestigen anzuziehen ist: aus 100% weißer Baumwolle, in zwei Versionen lieferbar, kurz, der Sitz und Rücken überzieht, oder lang, der auch die Beine überzieht.

Silla

Estructura de aleación de aluminio pulido o pintado de color negro, grafite o blanco. Asiento y respaldo acolchados en poliuretano. Tapizado desenfundable de tejido o de piel o no desenfundable de cuero. A pedido suministramos una funda de poner sobre la silla sin fijarla: de tejido 100% algodón, color blanco, disponible corta que cubre asiento y respaldo o larga que cubre también las patas.

Struttura / Frame / Structure / Gestell / Estructura



2271 / 2271/R

Liza
 Lievore, Altherr, Molina
 2015

Poltroncine

Gambe in legno massello di rovere verniciato, colore naturale, o in noce Canaletto colore naturale. Scocca con braccioli in polipropilene caricato fibra di vetro, colore bianco o nero. Imbottitura cuscino seduta in poliuretano. Rivestimento cuscino seduta sfilabile in stoffa o in pelle. Per la versione 2271/R rivestimento schienale sfoderabile in stoffa o pelle accoppiato a Dacron Du Pont.

Armchairs

Legs in natural painted solid oak, or in natural Canaletto walnut. Sling with armrests of polypropylene reinforced with glass fibre, in the shades white or black. Seat cushion upholstered with polyurethane. Seat cushion with removable cover in fabric or leather. For the model 2271/R removable backrest cover in fabric or leather with Dacron Du Pont.

Petits fauteuils

Pieds en bois massif rouvre verni naturel, ou en noyer Canaletto, couleur naturelle. Coque avec accoudoirs en polypropylène, renforcée de fibres de verre, dans les couleurs blanche ou noire. Rembourrage coussin assise en polyuréthane. Revêtement coussin assise déhoussable en tissu ou cuir. Pour le modèle 2271/R revêtement dossier déhoussable en tissu ou cuir, couplé à Dacron Du Pont.

Kleine Sessel

Beine aus massiver Eiche, naturfarben lackiert, oder aus naturfarbenem Nussbaum Canaletto. Sitzschale mit Armlehnen aus Polypropylen mit Glasfaser verstärkt, in den Farben weiß oder schwarz. Sitzkissen-Polsterung aus Polyurethan. Sitzkissen mit abnehmbarem Bezug aus Stoff oder Leder. Für die Version 2271/R, abnehmbarer Bezug der Rückenlehne aus Stoff oder Leder, mit Dacron Du Pont gekoppelt.

Butaquitas

Patas de madera maciza de roble, pintado color natural, o de nogal Canaletto color natural. Armazón con apoyabrazos de polipropileno reforzado con fibra de vidrio, color blanco o negro. Cojín asiento acolchado de poliuretano. Cojín asiento con tapizado desenfundable, de tejido o de piel. Por el modelo 2271/R tapizado del respaldo, desenfundable, de tejido o de piel acoplado con Dacron Du Pont.

Gambe / Legs / Pieds / Beine / Patas



Scocca / Sling / Coque / Sitzschale / Armazón

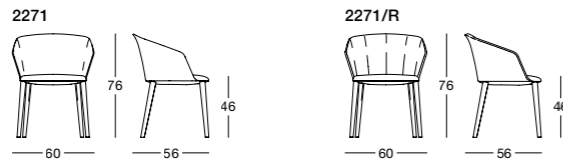

2271 / 2271/R
Liza2272 / 2272/R
Liza
Lievore, Altherr, Molina
2015**Poltroncine**

Gambe in acciaio cromato o verniciato colore bianco o nero. Scocca con braccioli in polipropilene caricato fibra di vetro, colore bianco o nero. Imbottitura cuscino seduta in poliuretano. Rivestimento cuscino seduta, sfilabile, in stoffa o in pelle. Per la versione 2272/R rivestimento schienale sfoderabile in stoffa o pelle accoppiato a Dacron Du Pont.

Armchairs

Legs in chromium-plated steel or painted in the shades black or white. Sling with armrests of polypropylene reinforced with glass fibre, in the shades white or black. Seat cushion upholstered with polyurethane. Seat cushion with removable cover in fabric or leather. For the model 2272/R removable backrest cover in fabric or leather with Dacron Du Pont.

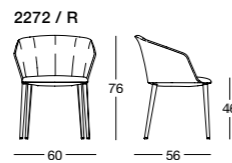
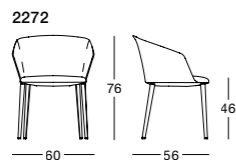
2278 / 2278/P
Lord
Alfredo Häberli
2003

Poltroncina girevole e reclinabile
Base a cinque razze in lega di alluminio lucidato con rotelle o con piedini (2278/P). Altezza seduta regolabile. Schienale reclinabile, con comando, fissabile in cinque posizioni diverse o oscillante in maniera continua. Imbottitura in poliuretano con molleggio su nastri elastici. Cuscino seduta, a richiesta, in poliuretano/Dacron Du Pont. Rivestimento sfilabile in stoffa o in pelle.

Reclining swivel armchair

Five-spoke base in polished aluminum alloy with castors or feet (2278/P). Adjustable seat height. The tilting back, with controls, can be set in five different positions or made to constantly rock. Polyurethane upholstery with elastic strips suspension. Seat cushion in polyurethane/Dacron Du Pont, on request. Removable fabric or leather cover.

Petit fauteuil tournant et inclinable

Base à cinq rayons en alliage d'aluminium poli à roulettes ou pieds (2278/P). Hauteur du siège réglable. Le dossier inclinable par commande peut être fixé dans cinq positions différentes ou basculer de manière continue. Rembourrage en polyuréthane avec suspension sur sangles élastiques. Sur demande, coussin du siège en polyuréthane/Dacron Du Pont. Revêtement déhoussable en tissu ou en cuir.

Verstellbarer Drehsessel

Fünfbeiniger Fuß aus polierter Aluminiumlegierung auf Rollen oder mit festen Füßen (2278/P). Sitzhöhe regulierbar. Neigung der Lehne über Mechanismus verstellbar, in fünf Positionen zu fixieren oder stufenlos beweglich. Polsterung aus Polyurethan mit Federung auf elastischen Gurten. Auf Wunsch Sitzkissen aus Polyurethan/Dacron Du Pont. Abnehmbarer Bezug aus Stoff oder Leder.

Butaquitas

Patas de acero cromado o pintado color blanco o negro. Armazón con apoyabrazos de polipropileno reforzado con fibra de vidrio, color blanco o negro. Cojín asiento con acolchado de poliuretano. Cojín asiento con tapizado desenfundable, de tejido o de piel. Por el modelo 2272/R tapizado del respaldo, desenfundable, de tejido o de piel acoplado con Dacron Du Pont.

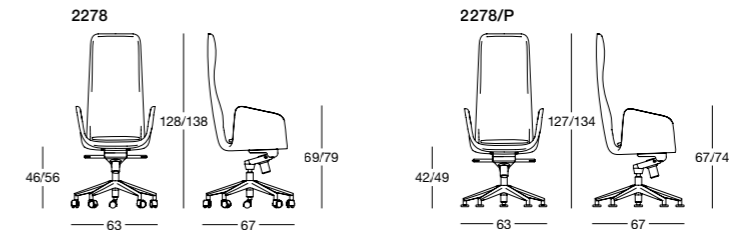
Gambe / Legs / Pieds / Beine / Patas**Scocca / Sling / Coque / Sitzschale / Armazón**2278 / 2278/P
Lord2262
Nena
Lanzavecchia+Wai
2020**Poltroncina**

Struttura in acciaio verniciato colore grafite o nero opaco. Imbottitura sedile e cuscino in poliuretano, imbottitura schienale in poliuretano schiumato autoestinguento. Rivestimento sfilabile in stoffa o in pelle.

Small armchair

Steel frame varnished graphite or matt black. Seat and cushion upholstered with polyurethane, backrest upholstered with self-extinguishing polyurethane foam. Removable fabric or leather cover.

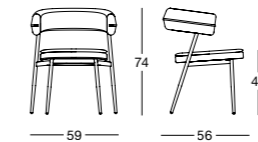
**Petit fauteuil**

Structure en acier verni graphite ou noir mat. Assise et coussin rembourrés en polyuréthane, dossier rembourré en mousse de polyuréthane autoextinguible. Revêtement déhoussable en tissu ou en cuir.

Sessel

Gestell aus Graphitfarben oder matten schwarz lackierten Stahl. Sitz und Kissen-Polsterung aus Polyurethan, Rückenlehne mit selbstlöschendem Polyurethanschaum gepolstert. Abnehmbarer Bezug aus Stoff oder Leder.

Butaquita

Estructura de acero pintado en los colores grafite o negro mate. Acolchado del asiento y cojín de poliuretano, acolchado del respaldo de espuma de poliuretano autoextintivo. Tapizado desenfundable de tejido o piel.

Struttura / Frame / Structure / Gestell / Estructura2054
Noli
Ludovica+Roberto Palomba
2018**Sedia**

Struttura in legno massello di faggio verniciato nei colori antracite, grigio cenere, blu mare, navy blue, rose-brick, mustard and verde salvia. Sedile imbottito e rivestito in stoffa o pelle, sfilabili.

Chair

Frame in solid beech wood, painted in the shades anthracite, ash-grey, navy blue, rose-brick, mustard and sage-green. Seat upholstered and covered with removable fabric or leather.

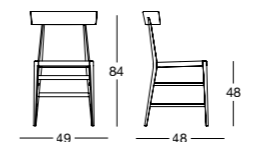
**Chaise**

Structure en hêtre massif verni dans les couleurs anthracite, gris cendre, bleue marine, rose brique, moutarde et vert sauge. Siège rembourré et recouvert en tissu ou cuir, déhoussable.

Stuhl

Gestell aus massiver Buche, lackiert in den Farben anthrazit, aschengrau, marineblau, Rosa-Ziegel, Senfbraun und Salbeigrün. Gepolsterter Sitz mit abnehmbarem Stoff oder Leder bezogen.

Silla

Estructura de haya maciza pintada en los colores antracita, gris ceniza, azul marino, rosa ladrillo, mostaza y verde salvia. Asiento acolchado y tapizado de tejido o piel, desenfundables.

Struttura / Frame / Structure / Gestell / Estructura

2080

TaliaRoberto Barbieri
2007**Sedia sovrapponibile**

Struttura in lega di alluminio lucidata oppure verniciato colore nero, grafite o bianco. Sedile e schienale imbottiti in poliuretano. Rivestimento sfilabile in stoffa o in pelle oppure non sfilabile in cuoio. A richiesta viene fornita una fodera coprisedia da calzare senza fissare: in tessuto 100% cotone, colore bianco, disponibile sia corta che ricopre sedile e schienale, sia lunga che ricopre anche le gambe. A richiesta è disponibile un carrello per il trasporto delle sedie impilate (massimo 15 sedie).

Stackable chair

Aluminum alloy frame, polished or painted black, graphite or white. Seat and back upholstered in polyurethane. Removable cover in fabric or leather or non-removable in cowhide. Upon request one loose cover to be put on without fixing can be supplied: in 100% white cotton, available either short covering seat and backrest or long covering legs too. Upon request a trolley for carrying the stacked chairs (max 15 chairs) is available.

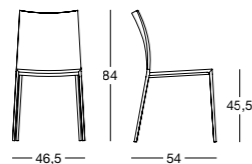

2090

ToniettaEnzo Mari
1985**Sedia**

Struttura in lega di alluminio lucidata o verniciato nero. Sedile e schienale in polipropilene ricoperto in cuoio 95 nei colori della cartella.

Chair

Polished or black painted aluminum alloy frame. Seat and back in polypropylene covered in cowhide 95 in the colours indicated on our colour card.

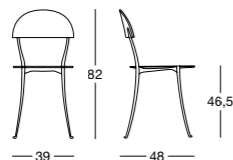
**Chaise superposable**

Structure en alliage d'aluminium poli ou verni, couleur noir, graphite ou blanc. Siège et dossier rembourrés en polyuréthane. Revêtement déhoussable en tissu ou en cuir ou pas déhoussable en cuir sellier. Sur demande on peut fournir une housse à poser sans la fixer pour protéger les chaises: en tissu 100% coton, couleur blanche, dans les versions courte qui couvre assise et dossier ou longue qui couvre même les pieds. Sur demande est disponible aussi un chariot pour déplacer les chaises superposées (maximum 15 chaises).

Stapelbarer Stuhl

Gestell aus polierter Aluminiumlegierung oder Graphit, schwarz oder weiß lackiert. Sitz und Rückenlehne Polyurethangepolstert. Abnehmbarer Bezug aus Stoff oder Leder oder aus nicht abnehmbarem Kernleder. Auf Nachfrage ist ein loser Bezug verfügbar, der auf dem Stuhl ohne befestigen anzuziehen ist: aus 100% weißer Baumwolle, in zwei Versionen lieferbar, kurz, der Sitz und Rücken überzieht, oder lang, der auch die Beine überzieht. Auf Nachfrage ist ein Wagen zum Transport der gestapelten Stühle (max 15 Stühle) lieferbar.

Silla apilable

Estructura de aleación de aluminio pulido o pintado de color negro, grafite o blanco. Asiento y respaldo acolchados en poliuretano. Tapizado desenfundable de tejido o de piel o no desenfundable de cuero. A pedido suministramos una funda de poner sobre la silla sin fijarla: de tejido 100% algodón, color blanco, disponible corta que cubre asiento y respaldo o larga que cubre también las patas. A pedido suministramos un carro para transportar las sillas apiladas (máximo 15 sillas).

Struttura / Frame / Structure / Gestell / Estructura

2261/A

TusaRodolfo Dordoni
2019**Poltroncina con schienale alto**

Gambe in acciaio verniciato colore grigio cenere o nero. Sedile in multistrato con imbottitura in poliuretano. Struttura schienale in acciaio con imbottitura in poliuretano. Rivestimento sfilabile in stoffa o in pelle. Disponibile anche la versione con sedile in pelle 95 e schienale in tessuto cat. 30.

Armchair with high backrest

Legs in ash-grey or black painted steel. Plywood seat upholstered with polyurethane. Steel backrest with polyurethane upholstery. Removable fabric or leather cover. The version with leather 95 covered seat cushion and backrest in fabric cat. 30 is also available.

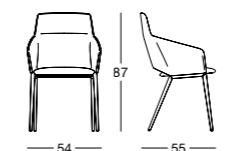
**Fauteuil avec dossier haut**

Pieds en acier verni dans les couleurs gris cendre ou noir. Assise en contreplaqué et rembourrée en polyuréthane. Structure du dossier en acier avec rembourrage en polyuréthane. Revêtement déhoussable en tissu ou en cuir. La version avec siège revêtu en cuir 95 et dossier en tissu cat. 30 est aussi disponible.

Sessel mit hoher Rückenlehne

Beine aus Aschengrau oder schwarz lackiertem Stahl. Sitz aus Sperrholz mit Polsterung aus Polyurethan. Rückenlehne aus Stahl mit Polsterung aus Polyurethan. Abnehmbarer Bezug aus Stoff oder Leder. Die Ausführung mit Sitzkissen aus Leder 95 und Rückenlehne mit Stoff Kat. 30 ist auch verfügbar.

Butaquita con respaldo alto

Patas de acero pintado en color gris ceniza o negro. Asiento en contrachapado y acolchado con poliuretano. Estructura del respaldo en acero acolchado de poliuretano. Tapizado desenfundable de tejido o de piel. Existe también una versión con asiento en piel 95 y respaldo en tejido cat. 30.

Gambe / Legs / Pieds / Beine / Patas

2261/B

TusaRodolfo Dordoni
2019**Poltroncina con schienale basso**

Gambe in acciaio verniciato colore grigio cenere o nero. Sedile in multistrato con imbottitura in poliuretano. Struttura schienale in acciaio con imbottitura in poliuretano. Rivestimento sfilabile in stoffa o in pelle. Disponibile anche la versione con sedile in pelle 95 e schienale in tessuto cat. 30.

Armchair with low backrest

Legs in ash-grey or black painted steel. Plywood seat upholstered with polyurethane. Steel backrest with polyurethane upholstery. Removable fabric or leather cover. The version with leather 95 covered seat cushion and backrest in fabric cat. 30 is also available.

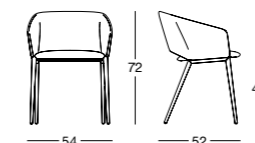
**Fauteuil avec dossier bas**

Pieds en acier verni dans les couleurs gris cendre ou noir. Assise en contreplaqué et rembourrée en polyuréthane. Structure du dossier en acier avec rembourrage en polyuréthane. Revêtement déhoussable en tissu ou en cuir. La version avec siège revêtu en cuir 95 et dossier en tissu cat. 30 est aussi disponible.

Sessel mit niedriger Rückenlehne

Beine aus Aschengrau oder schwarz lackiertem Stahl. Sitz aus Sperrholz mit Polsterung aus Polyurethan. Rückenlehne aus Stahl mit Polsterung aus Polyurethan. Abnehmbarer Bezug aus Stoff oder Leder. Die Ausführung mit Sitzkissen aus Leder 95 und Rückenlehne mit Stoff Kat. 30 ist auch verfügbar.

Butaquita con respaldo bajo

Patas de acero pintado en color gris ceniza o negro. Asiento en contrachapado y acolchado con poliuretano. Estructura del respaldo en acero acolchado de poliuretano. Tapizado desenfundable de tejido o de piel. Existe también una versión con asiento en piel 95 y respaldo en tejido cat. 30.

Gambe / Legs / Pieds / Beine / Patas

Tavoli, consolle, scrivanie
Tables, console tables, desks
Tables, consoles, tables bureau
Tische, Wandtische, Schreibtische
Mesas, consolas, mesas escritorios

2577 / 2577/C
Blanco
 Jacopo Zibardi
 2010

Tavoli
 Basamento e piano in Cristalplant®, materiale composito a base di resine poliestere e acriliche cariche di minerali, pigmentato in massa colore bianco opaco. Nella versione 2577/C il piano è in cristallo temperato, extra-chiaro acidato verniciato bianco.

Tables
 Base and top in Cristalplant®, composite material based on polyester and acrylic resins, loaded with minerals and mass pigmented in the shade of matt white. For the model 2577/C the top is in tempered, extraclear, acidated plate glass, painted in the shade of white.

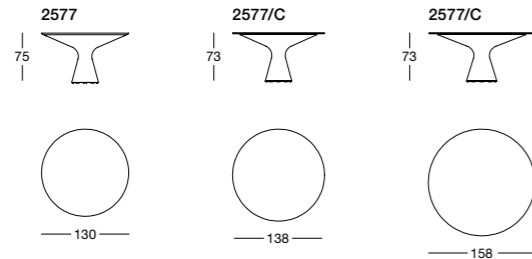

Tables
 Base et plateau en Cristalplant®, matériau composite à base de résines polyestère et acryliques, riches en minéraux, pigmenté dans la masse, couleur blanc mat. Pour la version 2577/C le plateau est en verre trempé, extra-clair acidifié verni blanc.

Tische
 Sockel und Tischplatte aus Cristalplant®, weißopak maßenpigmentiertem, mineralhaltigem Polyesterharz- und Acryl Kompositmaterial. Bei der Version 2577/C ist die Tischplatte aus extra-klarem, geätztem und gehärtetem Kristallglas, weißfarben.

Mesas
 Base y sobre de Cristalplant®, material compuesto a base de resinas poliéster y acrílicas cargadas de minerales, pigmentado en masa color blanco opaco. Por el modelo 2577/C el sobre es de cristal templado, extra-claro al ácido barnizado blanco.

2690
Cavour CM
 Omaggio a Carlo Mollino
 1949

Tavolo scrivania
 Gambe in legno massello di rovere naturale o tinto nero, oppure in legno massello di noce Canaletto; verniciatura con finitura a cera. Cassettiera e piano estraibile impiallacciati in rovere naturale o tinto nero, oppure in noce Canaletto, verniciatura con finitura a cera, entrambi rivestiti con cristallo temperato, extra-chiaro, retro-verniciato nero. Piano in cristallo trasparente o extra-chiaro, oppure cristallo fumé grigio, in abbinamento alla struttura in rovere tinto nero. A richiesta è disponibile un Executive kit che prevede il rivestimento in cuoio 95 nero del fondo del piano estraibile e del primo cassetto della cassetteria, un sottomano in cuoio 95 nero da cm 80x50 e un portapenna in legno massello realizzato nelle medesime finiture della scrivania.

Writing desk
 Legs in solid natural or black varnished oak, or in solid Canaletto walnut; wax-finished varnish. Extractable open tray and drawer element veneered in natural or black varnished oak, or in Canaletto walnut, wax-finished varnish, both covered with extra-clear tempered plate glass, back-painted in black. Clear or extra clear plate glass top or smoky grey plate glass top, matching the black oak frame. Upon request an Executive kit is available, including the bottom of the extractable open tray and the first drawer covered with black cowhide 95, one desk pad in black cowhide 95, size cm. 80x50 and one pen-holder in solid wood, made in the same finishes as the writing desk.

Table bureau
 Pieds en rovere naturel massif ou teinté noir ou en noyer Canaletto massif; verni finition cirée. Bloque tiroirs et plateau coulissant plaqués en rovere naturel ou teinté noir, ou en noyer Canaletto, verni finition cirée, les deux recouverts en verre trempé, extra clair, dos-vernifié noir. Plateau en verre extra clair ou transparent, ou en verre gris fumé, en combinaison avec la structure en rovere teinté noir. Sur demande il est disponible un Executive kit pour recouvrir en cuir sellier 95 noir le fond du plateau coulissant et du premier tiroir du caisson, un sous-main en cuir sellier 95 noir de cm 80x50 et pot à crayons en bois massif réalisé dans les mêmes finitions du bureau.

Schreibtisch
 Beine aus massiver naturfarbener oder schwarz gebeizter Eiche, oder aus massivem Nussbaum Canaletto; Lackierung mit Wachs-Endbehandlung. Ausziehbares offenes Tablett und Schublade furniert mit naturfarbener oder schwarz gebeizter Eiche, oder mit Nussbaum Canaletto; Lackierung mit Wachs-Endbehandlung. Beide sind bezogen mit extra-klarem gehärtetem und nach hinten schwarz lackiertem Kristallglas. Tischplatte aus transparentem oder extra-klarem Kristallglas, oder aus grau rauchfarbenem Kristallglas, passend zum Gestell aus schwarz gebeizter Eiche. Auf Nachfrage ist ein Executive Kit verfügbar, das den Bodenbezug des ausziehbaren offenen Tablett und der ersten Schubladen aus schwarzem Kernleder 95, sowie eine Schreibunterlage aus schwarzem Kernleder 95, Abmessungen 80x50 cm und einen Holzstifthalter in den gleichen Ausführungen des Schreibtisches enthält.

Mesa escritorio
 Patas de madera maciza de roble natural o teñido negro o de nogal Canaletto macizo; pintura con acabado de cera. Cajonera y top extraíble contrachapados de roble natural o teñido negro, o de nogal Canaletto, pintura con acabado de cera, ambos tapizados de cristal templado extra claro, parte trasera pintada negra. Superficie de cristal transparente o extra claro, o de cristal gris humo, combinado con la estructura de roble teñido negro. Sobre pedido es disponible un Executive kit para tapizar de cuero 95 negro el fondo del top extraíble y del primero cajón de la cajonera, un deskpad de cuero 95 negro de cm 80x50 y un portapápiz de madera maciza realizado en los mismos acabados del escritorio.

Gambe / Legs / Pieds / Beine / Patas



Piano / Top / Plateau / Platte / Sobre

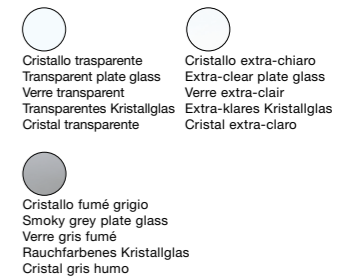

2730
Calamo
 Gabriele Rosa
 2013

Scrigno
 Struttura e piano in acciaio verniciato colore bianco, nero o grafite. Piano e vano portaoggetti in cuoio pigmentato 90. Il vano è accessibile mediante apertura a ribalta.

Desk
 Varnished steel frame and top in black, white or graphite. Top and storage space in cowhide pigmentato 90. The storage space is accessed by a drop-leaf opening.

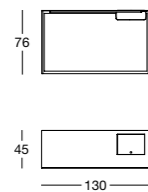
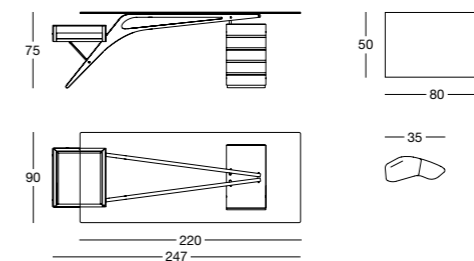

Table bureau
 Structure et plateau en acier verni couleur blanche, noire ou graphite. Plateau et élément porte-objets en cuir sellier pigmentato 90. L'élément est accessible par une ouverture basculante.

Schreibtisch
 Gestell und Platte aus weiß-graphitfarben oder schwarz lackiertem Stahl. Platte und Ablagefach aus Kernleder pigmentato 90. Das Ablagefach ist mit Kippöffnung versehen.

Escritorio
 Estructura y sobre de acero barnizado color blanco, negro o grafito. Sobre y compartimento portaobjetos de cuero pigmentato 90. Se puede acceder al compartimento mediante apertura abatible.

Struttura / Frame / Structure / Gestell / Estructura



2725
Comacina
 Piero Bottoni
 1930

Tavolo scrivania con cassetti
 Struttura in tubo di acciaio inox. Piano e cassetteria verniciati goffrati antigraffio nei colori bianco o nero. Il piano può essere con inserto in cuoio pigmentato 90.

Writing desk with storage unit
 Stainless steel tubular frame. Top and drawer unit finished with scratch resistant embossing in the colours black or white. The top can be with cowhide pigmentato 90 insert.

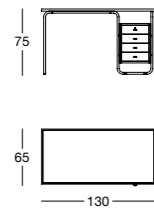

Table bureau avec tiroirs
 Structure en tube d'acier inox. Plateau et caisson vernis anti-rayures dans les couleurs blanche ou noire. Le plateau peut être avec finition en cuir sellier pigmentato 90.

Schreibtisch mit Schubladen
 Gestell aus Inox-Stahl-Rohr. Platte und Schubladen mit kratzester Lackierung in den Farben weiß oder schwarz. Die Platte ist auch mit eingelegtem Kernleder pigmentato 90.



Mesa escritorio con cajones
 Estructura en tubo de acero inox. Sobre y cajonera lacados con relieve antirasguño en los colores blanco o negro. El sobre puede ser también con inserción de cuero pigmentato 90.

2575
Elica
 Prospero Rasulo
 2009

Tavolo
 Basamento in Cristalplant®, materiale composito a base di resine poliester e acriliche cariche di minerali pigmentato in massa colore bianco opaco. Piano in cristallo temperato, extrachiaro acidato verniciato bianco, oppure in marmo bianco di Carrara. È prevista anche la versione con base verniciata opaca nera in abbinamento al piano in marmo Sahara Noir, con verniciatura protettiva antimacchia in poliester trasparente opaco.

Table
 Base in Cristalplant®, composite material based on polyester and acrylic resins, loaded with minerals and mass pigmented in the shade of matt white. Tempered, extraclear, acidated plate glass top painted in the shade of white or made of white Carrara marble. The version with matt black varnished base matching the Sahara Noir marble top, with stain-resistant clear matt polyester protective varnish, is also available.

Table
 Base en Cristalplant®, matériau composite à base de résines polyester et acryliques, riches en minéraux, pigmenté dans la masse, couleur blanc mat. Plateau en verre trempé, extraclair acidifié verni blanc, ou bien en marbre blanc de Carrare. La version avec base vernie noire mat en combinaison avec plateau en marbre Sahara Noir avec vernis de protection anti-taches en polyester transparent mat est aussi disponible.

Tisch
 Sockel aus Cristalplant®, weißopak maßenpigmentiertem, mineralhaltigem Polyesterharz und Acryl Kompositmaterial. Tischplatte aus weißem extraklarem, geätztem und gehärtetem Kristallglas oder aus weißem Carrara-Marmor. Die Ausführung mit schwarz mattem lackiertem Sockel nur passend zur Platte aus Sahara Noir Marmor, mit Fleckenschutz Lackierung aus klarem mattem Polyester, ist auch lieferbar.

Mesa
 Base de Cristalplant®, material compuesto a base de resinas de poliéster y acrilicas cargadas de minerales pigmentado en masa color blanco opaco. Superficie de cristal templado, extraclaro al ácido, barnizado blanco o en mármol blanco de Carrara. Existe también la versión con base barnizada mate color negro en combinación solo con la superficie de mármol Sahara Noir con laca de protección antimancha, en poliéster opaco transparente.

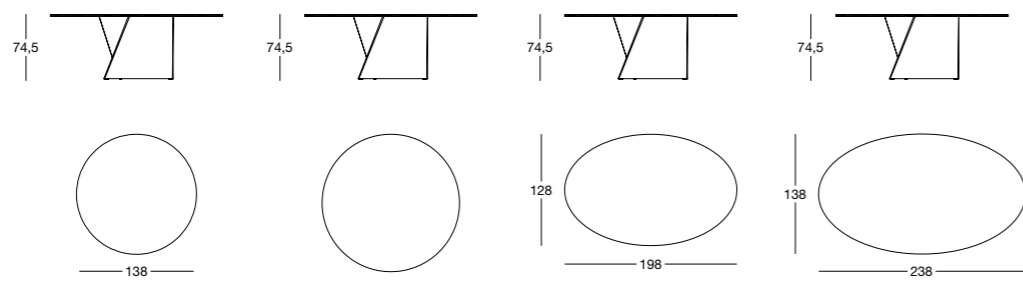

Solo per piano in marmo /
 For marble top only /
 Seulement pour plateau
 en marbre / Nur für Marmor-
 Platte / Solo por sobre
 en mármol

2576
Elica
 Prospero Rasulo
 2010

Tavolo
 Basamento in Cristalplant®, materiale composito a base di resine poliester e acriliche cariche di minerali pigmentato in massa colore bianco opaco o laccato nero. Piano in cristallo trasparente oppure fumé grigio in abbinamento solo con base nera.

Table
 Base in Cristalplant®, composite material based on polyester and acrylic resins, loaded with minerals and mass pigmented in the shade of matt white, or black glossy lacquered. Plate glass top, clear or smoky grey, only matching the black base.

Table
 Base en Cristalplant®, matériau composite à base de résines polyester et acryliques, riches en minéraux, pigmenté dans la masse, couleur blanc mat, ou laqué brillant noir. Plateau en verre transparent ou fumé gris en combinaison seulement avec la base noire.

Tisch
 Sockel aus Cristalplant®, weißopak maßenpigmentiertem, mineralhaltigem Polyesterharz und Acryl Kompositmaterial, oder schwarz glanzlackiert. Tischplatte aus Kristallglas, klar oder grau rauchfarben nur passend zu dem schwarzem Sockel.

Mesa
 Base de Cristalplant®, material compuesto a base de resinas de poliéster y acrilicas cargadas de minerales pigmentado en masa color blanco opaco, o lacada brillante negra. Superficie de cristal transparente o gris humo en combinación solo con la base negra.

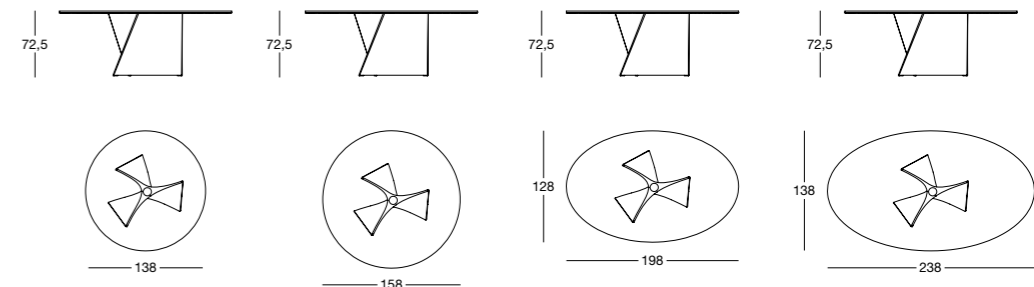
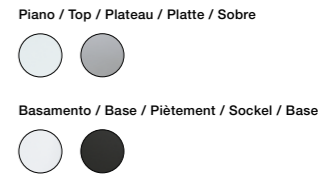

2574
Fenice
 Piero Bottoni
 1936

Tavolo
 Esempio numerato. Struttura in Polimex®, rivestita in cemento con finitura acrilica e trattamento di protezione nano tecnologico antimacchia a base di biossido di titanio, colore grigio.

Table
 Numbered piece. Frame in Polimex®, covered with acryl finish cement with protective titanium dioxide nanotech stain-resistant treatment, in the shade of grey.

Table
 Exemple énuméré. Structure en Polimex®, revêtu en ciment avec finition acrylique et traitement de protection nano technologique anti-tache à base de bioxyde de titane, couleur gris.

Tisch
 Nummeriertes Exemplar. Gestell aus Polimex®, mit Zement verkleidet, mit Acrylfinish und nanotechnologischer Fleckenschutzbehandlung mit Titandioxid, in der Farbe grau.

Mesa
 Pieza numerada. Estructura de Polimex®, revestido en cemento con acabado acrílico y tratamiento de protección nanotecnológico antimancha a base de dióxido de titanio, color gris.

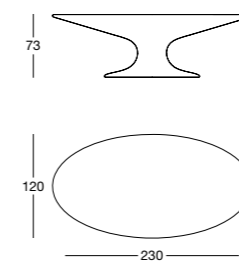

2650
Leonardo
 Achille Castiglioni
 1969

Tavolo da lavoro
 Struttura in faggio evaporato, colore naturale. Piano placcato in laminato colore bianco, oppure in cristallo temperato. Regolabile in altezza.

Working table
 Natural varnished steam-treated beech trestle. Top coated with white plastic laminate, or with tempered plate glass. Adjustable height.

Table de travail
 Structure en hêtre évaporé, couleur naturelle. Plateau plaqué en laminé plastique, couleur blanche, ou en verre trempé. Hauteur réglable.

Arbeitstisch
 Tragböcke aus gedampfter Buche, naturfarben. Platte mit weißem Schichtpreßstoff Laminat beschichtet, oder aus hitzebeständigem Kristallglas. Höhenverstellbar.

Mesa de trabajo
 Estructura de haya vaporizada, color natural. Sobre aplacado con laminado, color blanco o de cristal templado. Altura regulable.

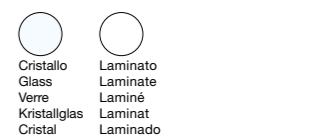

2650
Leonardo

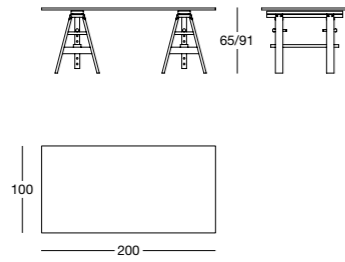

2530
Marcuso
Marco Zanuso
1969

Tavolo

Piano in cristallo, trasparente oppure rivestito in cemento, colore antracite, con finitura acrilica e trattamento di protezione nanotecnologico antimacchia. Gambe in acciaio inox, abbinato al piano in cristallo trasparente o verniciate colore antracite abbinato al piano rivestito in cemento.

Table

Plate glass top, either clear or covered in acrylic finish cement in the shade anthracite with protective nanotech stain-resistant treatment. Removable legs, in stainless steel, matching the clear top, or in anthracite painted steel, matching the cement covered top.

Table

Plateau en verre, transparent ou en ciment couleur anthracite avec une finition acrylique et un traitement nanotechnologique antitaches. Pieds en acier, finition inox pour le plateau en verre ou en couleur anthracite pour le plateau en ciment.

Tisch

Platte aus Kristallglas, klar oder mit anthrazitfarbenem Zement verkleidet, mit Akryl Finish und nanotechnologischer Fleckenschutzbehandlung. Beine aus Inox Stahl, passend zu klarer Kristallglas-Platte, oder anthrazitfarben lackiert, passend zur Zement-Platte.

Mesa

Sobre de cristal, transparente o cemento de color antracita, con acabado acrílico y un tratamiento nanotecnológico anti manchas. Patas de acero inox, con el sobre en cristal transparente, o color antracita con el sobre en acabado cemento.

Piano / Top / Plateau / Platte / Sobre



Struttura / Frame / Structure / Gestell / Estructura

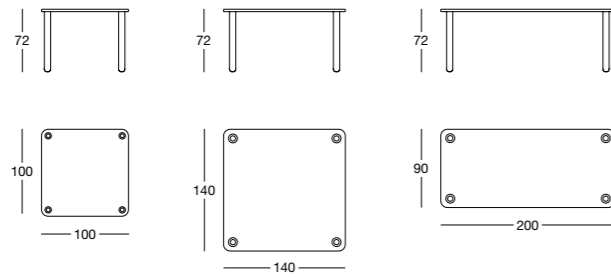

2337
Orione
Roberto Barbieri
1996

Tavolo

Piano in cristallo. Struttura in rovere naturale con tiranti in acciaio nichelato e spazzolato, oppure in rovere tinto nero, con tiranti in acciaio nichel satinato nero.

Table

Plate glass top. Frame in natural oak with brushed and nickel-plated steel tie-rods, or in black varnished oak, with black nickel satin finished steel tie-rods.

Table

Plateau en verre. Structure en rovere naturel, avec tirants en acier niquelulé et brossé, ou en rovere teinté noir, avec tirants en acier nickel-satiné noir.

Tisch

Platte aus Kristallglas. Gestell aus naturfarbener Eiche, mit Streben aus vernickeltem und gebürstetem Stahl, oder aus schwarz gebeizter Eiche mit Streben aus schwarz-vernickeltem und mattiertem Stahl.

Mesa

Superficie de cristal. Estructura de roble natural, con tirantes de acero niquelado y cepillado, o de roble teñido negro, con tirantes de acero niquelado mate negro.

Struttura / Frame / Structure / Gestell / Estructura

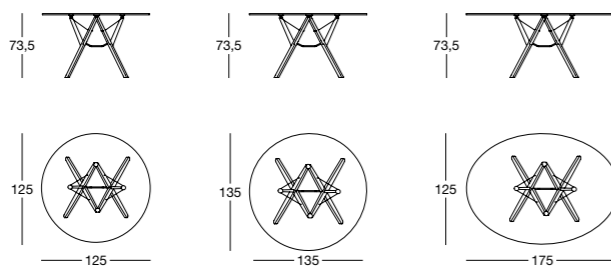

2625
Poker
Joe Colombo
1968

Tavolo da gioco

Piani in laminato plastico stratificato, colore bianco. Panno verde con bordo in pelle, amovibile. Gambe in acciaio inox.

Card table

Tops in white layered plastic laminate. Removable, leather trimmed green baize. Stainless steel legs.

Table de jeu

Plateaux en laminé plastique stratifié, couleur blanche. Tapis vert avec bords en cuir, amovible. Pieds en acier inox.

Spieltisch

Tischplatten aus massivem Schichtpreßstoff Laminat, weißfarben. Grünes Filztuch mit Lederrand, abnehmbar. Beine aus Inox-Stahl.

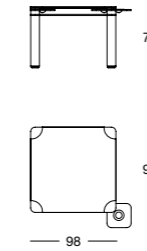

2600 / 2830
Quaderna
Superstudio
1970

Tavolo / tavolo scrivania

Struttura in legno tamburato placcato in laminato Print, colore bianco, a stampa digitale a quadretti neri con interasse di 3 cm.

Table / writing desk

Honeycomb core structure coated with white plastic laminate, digitally printed with black squares at 3 cm spacing.

Table / table bureau

Structure en panneau alvéolaire plaqué en Print, couleur blanche, imprimé en digital à carrés noirs avec entraxe de 3 cm.

Tisch / Schreibtisch

Gestell aus Sperrholz mit weißem Print belegt. Digitaldruck mit kariertem Muster, Linienabstand 3 cm.

Mesa / mesa escritorio

Estructura de madera enchapada aplacada con laminado Print, color blanco, a impresión digital en cuadritos negros de 3 cm.

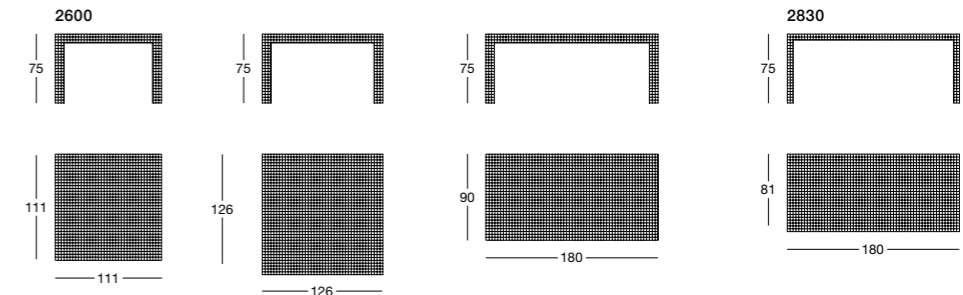

710
Quaderna
Superstudio
1970

Consolle

Struttura in legno tamburato placcato in laminato Print, colore bianco, a stampa digitale a quadretti neri con interasse di 3 cm.

Console table

Honeycomb core frame coated with white plastic laminate, digitally printed with black squares at 3 cm spacing.

Console

Structure en panneau alvéolaire plaqué en Print, couleur blanche, imprimé en digital à carrés noirs avec entraxe de 3 cm.

Wandtisch

Gestell aus Sperrholz mit weißem Print belegt. Digitaldruck mit kariertem Muster, Linienabstand 3 cm.

Consola

Estructura de madera aplacada con laminado Print, color blanco, a impresión digital en cuadritos negros de 3 cm.

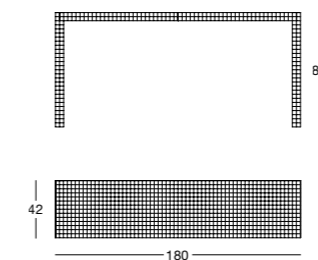

2320
Reale
 Omaggio a Carlo Mollino
 1948

Tavolo
 Piano in cristallo trasparente con o senza bordi bisellati, oppure in marmo Emperador, con verniciatura protettiva antimacchia in poliestere trasparente opaco. Struttura in legno massello di rovere naturale o tinto noce Canaletto, oppure tinto nero; verniciatura con finitura a cera.

Table
 Clear plate glass top, with or without bevelled edges or in Emperador marble, with stain-resistant protective varnish, in clear matt polyester. Frame in solid natural or black varnished oak, or in Canaletto walnut-dyed oak; wax-finished varnish.

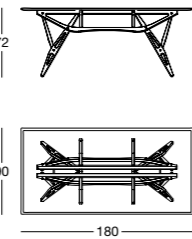
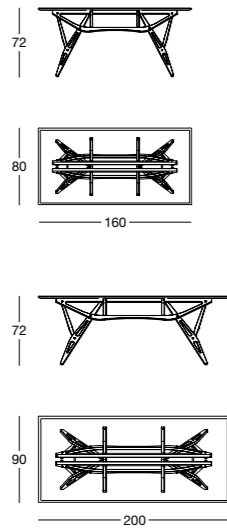

2320
Reale CM
 Omaggio a Carlo Mollino
 1948

Tavolo
 Struttura in legno massello di rovere naturale o tinto nero oppure in legno massello di noce Canaletto colore naturale; verniciatura con finitura a cera. Piano in cristallo extra-chiaro con bordo a taglio inclinato, oppure in cristallo fumè grigio con bordo a taglio inclinato, in abbinamento alla struttura in rovere tinto nero.

Table
 Frame in solid natural or black varnished oak, or in solid natural Canaletto walnut; wax-finished varnish. Extra clear plate glass top, with inclined cut edges, or smoky grey plate glass top, with inclined cut edges, matching the black oak frame.

Table
 Structure en rovere naturel massif ou teinté noir ou en noyer Canaletto massif, couleur naturelle; verni finition cirée. Plateau en verre extra- clair à bord coupé oblique, ou en verre gris fumé à bord coupé oblique, en combinaison avec la structure en rovere teinté noir.

Tisch
 Gestell aus massiver naturfarbener oder schwarz gebeizter Eiche, oder aus massivem naturfarbenem Nussbaum Canaletto. Lackierung mit Wachs-Endbehandlung. Tischplatte aus extra-klarem Kristallglas, mit geneigten geschnittenen Rändern, oder aus grau rauchfarbenem Kristallglas mit geneigten geschnittenen Rändern, passend zu dem Gestell aus schwarz gebeizter Eiche.

Mesa
 Superficie de cristal transparente con o sin borde biselado, o en mármol Emperador, con laca de protección anti mancha en poliéster transparente mate. Estructura de madera maciza de roble natural o teñido negro o de roble teñido nogal Canaletto; pintura con acabado de cera.

Struttura / Frame / Structure / Gestell / Estructura

- Rovere naturale / Natural oakwood / Rouvre naturel / Naturfarbene Eiche / Roble natural
- Rovere tinto nero / Black varnished oak / Rouvre teinté noir / Schwarz-gebeizte Eiche / Roble teñido negro
- Rovere tinto noce Canaletto / Canaletto walnut dyed oak / Rouvre teinté noyer Canaletto / Nussbaum Canaletto gebeizte Eiche / Roble teñido nogal Canaletto

Piano / Top / Plateau / Platte / Sobre

- Cristallo / Plate glas / Verre / Kristallglas / Cristal
- Marmo Emperador / Emperador marble / Marbre Emperador / Emperador Marmor / Marmól Emperador

2320
Reale CM

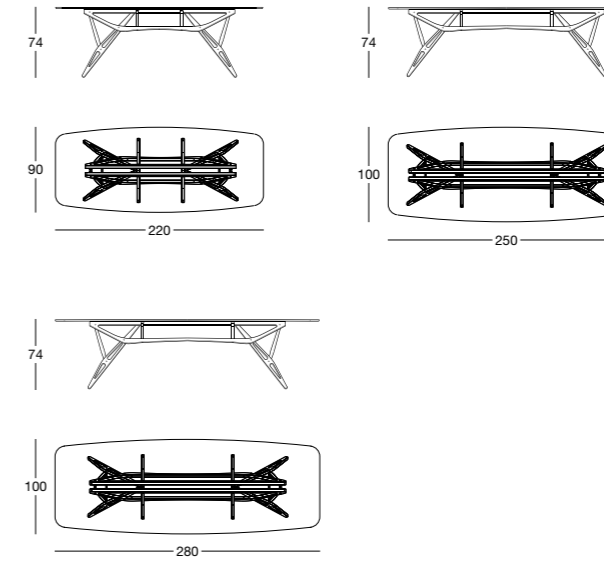

Piano / Top / Plateau / Platte / Sobre

- Cristallo extra-chiaro / Extra-clear plate glass / Verre extra-clair / Extra-klares Kristallglas / Cristal extra-claro
- Cristallo fumé grigio / Smoky grey plate glass / Verre gris fumé / Rauchfarbenes Kristallglas / Cristal gris humo

2315
Santiago
 Frank Rettenbacher
 2015

Tavolo
 Piano e gambe in legno massello di noce Canaletto verniciato colore naturale o in legno massello di rovere verniciato colore naturale o a poro aperto, colore nero o bianco. Tiranti di rinforzo in acciaio verniciato colore nero per la versione in noce Canaletto e in rovere verniciato nero, colore bianco per la versione in rovere verniciato bianco, oppure colore bordeaux o nero per la versione in rovere naturale.

Table
 Top and legs in solid Canaletto walnut, natural painted or in solid oak, natural painted or with an open pore black or white finish. Reinforcing tie rods in black painted steel for the model in Canaletto walnut and in black painted oak, in white painted steel for the model in white painted oak, while for the model in natural oak they are available in burgundy or black painted steel.

Table
 Plateau et pieds en bois massif noyer Canaletto verni naturel ou en rovere massif verni naturel ou verni à pore ouvert dans les couleurs noire ou blanche. Tirants de renforcement en acier verni noir pour la version en noyer Canaletto et en rovere verni noir; vernis blancs pour la version en rovere verni blanche; ou vernis bordeaux ou noirs pour la version en rovere naturel.

Tisch
 Platte und Beine aus Massivholz in naturfarben lackiertem Nussbaum Canaletto, oder aus Massivholz in naturfarben lackierter Eiche, oder weiß oder schwarz lasiert. Zugstangen zur Verstärkung aus schwarz lackiertem Stahl für die Version in Nussbaum Canaletto und in schwarz lasierter Eiche, aus weiß lackiertem Stahl für die Version in weiß lasierter Eiche, oder aus Burgunderrot oder schwarz-lackiertem Stahl für die Version in naturfarbener Eiche.

Mesa
 Sobre y patas de madera maciza de nogal Canaletto barnizado color natural, o de madera maciza de roble barnizado color natural o a poro abierto color negro o blanco. Tirantes de refuerzo de acero pintado color negro por la versión en nogal Canaletto y en roble pintado negro; de color blanco por el modelo en roble pintado blanco; o de color burdeos o negro por el modelo en roble natural.

Tiranti / Tie-rods / Tirants / Zugstangen / Tirantes

- Rovere naturale / Natural oakwood / Rouvre naturel / Naturfarbene Eiche / Roble natural
- Noce Canaletto / Canaletto walnut / Noyer Canaletto / Nussbaum Canaletto / Nogal Canaletto

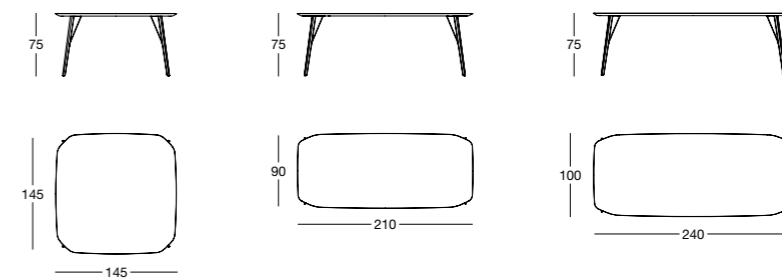

2740
Tucano
 Monica Förster
 2020

Scrittoio
 Struttura in acciaio verniciato colore nero opaco. Piano rivestito in cuoio pigmentato 90.

Writing desk
 Matt black varnished steel frame. Top covered with cowhide pigmentato 90.

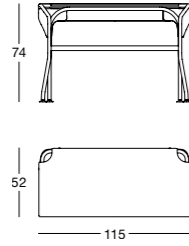

Table bureau
 Structure en acier verni noir mat. Plateau en cuir sellier pigmentato 90.

Schreibtisch
 Gestell aus mattem schwarz lackiertem Stahl. Platte mit Kernleder pigmentato 90 bezogen.

Escritorio
 Estructura de acero pintado color negro mate. Superficie tapizada de cuero pigmentado 90.

2317
Tweed
 Garcia Cumini
 2017

Tavolo
 Piano in legno placcato in rovere, verniciato colore naturale, con sottopiano verniciato colore grigio, o a poro aperto colore nero, con sottopiano verniciato colore nero, oppure in noce Canaletto, verniciato colore naturale, con sottopiano verniciato colore nero. Gambe in abbinamento rispettivamente in legno massello di rovere verniciato colore naturale, o di rovere verniciato a poro aperto nero, oppure di noce Canaletto, verniciato colore naturale. Piedino regolabile in alluminio verniciato nero.

Table
 Top available either in natural painted oak veneered wood, with grey painted under-top, or black painted with an open pore, with black painted under-top or in natural painted Canaletto walnut veneered wood, with black painted under-top. Legs are available respectively in natural painted solid oak, or in open pore black painted oak, or in natural painted Canaletto walnut. Black painted aluminium adjustable foot.

Table
 Plateau en bois plaqué dans la finition rouvre, verni couleur naturel, avec un sous-plateau verni gris, ou verni à pore ouvert noir avec sous-plateau verni noir, ou plaqué en noyer Canaletto, verni couleur naturel avec un sous-plateau verni noir. Pieds en combinaison respectivement en bois massif de rouvre, verni couleur naturel, ou en rouvre verni à pore ouvert noir, ou en noyer Canaletto, verni couleur naturel. Petit pied réglable en aluminium verni noir.

Tisch
 Holzplatte furniert mit naturfarben lackierter Eiche, mit grau lackierter Unterplatte, oder schwarz lasiert mit schwarz lackierter Unterplatte, oder mit naturfarben lackiertem Nussbaum Canaletto, mit schwarz lackierter Unterplatte. Beine aus massiver Eiche, naturfarben lackiert, oder bzw. aus schwarz lasierter Eiche oder bzw. aus Nussbaum Canaletto, naturfarben lackiert. Verstellbarer Fuß aus schwarz lackiertem Aluminium.

Mesa
 Superficie de madera chapada en roble barnizado natural, con la parte inferior pintada de color gris, o pintado a poro abierto, color negro, con la parte inferior pintada de color negro, o en nogal Canaletto barnizado natural, con la parte inferior pintada de color negro. Patas combinadas respectivamente en madera maciza de roble, barnizado natural, o de roble pintado a poro abierto negro, o de nogal Canaletto barnizado natural. Pie regulable en aluminio pintado negro.

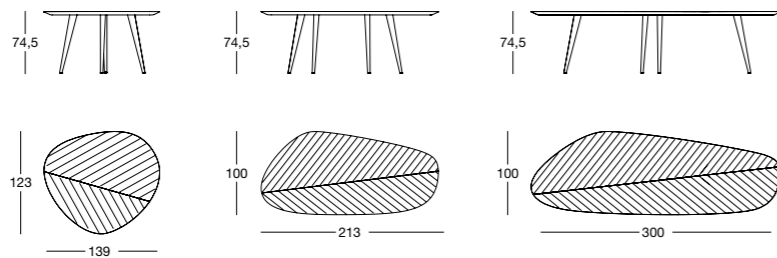

Letti, materassi, guanciali Beds, mattresses, pillows Lits, matelas, oreillers Betten, Matratzen, Kopfkissen Camas, colchónes, almohadas

1874 / 1875

Box
Emaf Progetti
2005

Letti con o senza vano contenitore

Struttura in acciaio. Molleggio in doghe di faggio curvato con regolatori di rigidità. Testiera e base imbottite in poliuretano/ fibra poliester termolegata. Rivestimento trapuntato, sfilabile, in stoffa o in pelle. Il letto, nella versione 1874, all'interno della base, è dotato di un vano contenitore al quale si accede alzando il materasso tramite un meccanismo. A richiesta, solo per il modello 1875, è possibile fornire il letto con supporti angolari regolabili che permettono l'inserimento della rete ad altezze diverse e la misura per il materasso da 210 cm di lunghezza.

Beds with or without container unit

Steel frame. Suspension in bent beech strips with stiffness adjusters. Upholstered base and headboard in polyurethane/heat-bound polyester fibre. Removable quilted cover in fabric or leather. The model 1874, fitted inside the base, is furnished with a container unit accessed by lifting the mattress with a special device. Upon request, only for the model 1875, the bed with adjustable corner supports that enable to place the springing at different heights and the bed size for 210 cm. long mattress can be supplied.

Lits avec ou sans élément de rangement

Structure en acier. Suspension en douves de hêtre courbé, avec régulateurs de rigidité. Cadre et tête de lit rembourrés en polyuréthane/fibre polyester liée à chaud. Revêtement surpiqué déhoussable en tissu ou en cuir. En version 1874 le lit, à l'intérieur du cadre, est doté d'un élément de rangement auquel l'on accède en levant le matelas à l'aide d'un mécanisme. Sur demande, seulement pour le modèle 1875, il est possible de fournir le lit avec des supports angulaires réglables qui permettent l'introduction du sommier à des hauteurs différentes et dans la mesure pour un matelas de 210 cm de longueur.

Betten mit oder ohne Stauraum

Gestell aus Stahl. Lattenrost aus gebogenen Buchen- Dauben, in der Nachgiebigkeit regulierbar. Unterteil und Kopfteil mit Polsterung aus Polyurethan/ wärmegebundener Polyesterfaser. Abnehmbarer Bezug aus Stepp-Stoff oder Leder. Die Ausführung 1874 hat im Bettrahmen einen integrierten Stauraum, der über einen Mechanismus zum Anheben der Matratze zugänglich wird. Auf Nachfrage, nur für die Version 1875, ist das Bett mit verstellbaren Winkelhalterungen lieferbar, die die Einfügung des Rostes in verschiedenen Höhen ermöglichen. Die Bett-Maße für die Matratze 210 cm lang ist auch verfügbar.

Camas con o sin base contenedora

Estructura de acero. Somier con lamas de haya curvadas con reguladores de rigidez. Base y cabezal acolchados de poliuretano/fibra poliester termounida. Tapizado pespunteado desenfundable de tejido o de piel. El modelo 1874 está provisto de una base contenedora a la cual se accede alzando el colchón por medio de un mecanismo al efecto. Sobre pedido, solo por el modelo 1875 podemos suministrar la cama con los soportes angulares regulables para poder poner el somier a alturas diferentes y en la medida para el colchón de 210 cm de largo.

151x218 cm (140x200 cm)*
171x218 cm (160x200 cm)*
191x218 cm (180x200 cm)*
211x218 cm (200x200 cm)*

* Dimensioni del materasso /
Mattress sizes / Dimensions du
matelas / Abmessungen der
Matratze / Medidas del colchón

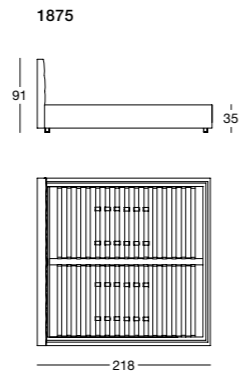
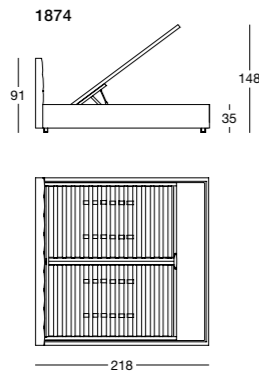

1615
Florin
Roberto Lazzeroni
2018

Letto

Struttura testiera e piedini in frassino verniciato a poro aperto colore grigio cenere, senape o blu mare. Imbottitura in poliuretano/ fibra poliester termolegata. Rivestimento, sfilabile, in stoffa o pelle. Struttura base in acciaio con doghe in faggio curvato (larghezza 6,8 cm), verniciato naturale. È disponibile la versione del letto con tessuto decorativo Henri (Misia-Casamance Group), in due abbinamenti: Henri blu di Prussia – Quadrifoglio 27013 (1); Henri ametista – Quadrifoglio 27057 (2). A richiesta sono disponibili anche la misura per il materasso da 210 cm di lunghezza e la versione rete con doghe di larghezza 3,8 cm.

Bed

Headboard frame and feet veneered in open pore painted ash in the shades ash-grey, mustard or navy blue. Upholstery in polyurethane/heat bound polyester fibre. Removable fabric or leather cover. The base has a steel frame with natural bent beech strips (6,8 cm wide). The model with decorative fabric Henri (Misia-Casamance Group) in two combinations is available: Henri blu di Prussia – Quadrifoglio 27013 (1); Henri ametista – Quadrifoglio 27057 (2). Upon request the bed size for 210 cm long mattress and the springing with strips 3,8 cm. wide are also available.

Lit

Structure de la tête et pied du lit en frêne verni à pore ouvert couleur gris cendre, moutarde, ou bleue marine. Rembourrage en polyuréthane/fibre polyester liée à chaud. Revêtement déhoussable en tissu ou en cuir. Structure en acier avec douves en hêtre courbé (largeur 6,8 cm), verni naturel. Le lit est disponible avec le tissu décoratif Henri (Misia-Casamance Group), en deux combinaisons: Henri blu di Prussia – Quadrifoglio 27013 (1); Henri ametista – Quadrifoglio 27057 (2). Sur demande, il est prévu aussi la mesure pour le matelas en longueur de 210 cm et le sommier avec douves 3,8 cm. large.

1615
Florin

178x223 cm (160x200 cm)*
188x223 cm (170x200 cm)*
198x223 cm (180x200 cm)*

* Dimensioni del materasso /
Mattress sizes / Dimensions du
matelas / Abmessungen der
Matratze / Medidas del colchón

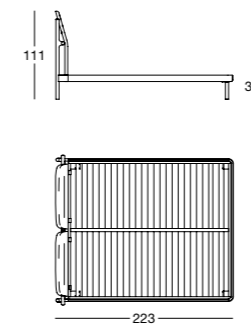

1879
Grangala
Gabriele Rosa
2018

Letto

Piedini e mensole in acciaio rivestiti in cuoio pigmentato 90. Struttura in acciaio con doghe in faggio curvato, verniciato naturale. Imbottitura testiera e base in poliuretano/fibra poliester termolegata. Rivestimento, sfilabile, in stoffa o pelle. A richiesta sono disponibili le misure per i materassi da 210 e 220 cm di lunghezza ed è possibile rivestire interamente il retro della testiera nel medesimo tessuto o pelle del letto.

Bed

Steel feet and shelves covered with cowhide pigmentato 90. Steel frame with suspension on natural bent beech strips. Base and headboard upholstered in polyurethane/heat bound polyester fibre. Removable fabric or leather cover. Upon request the bed sizes for 210 cm. and 220 cm. long mattresses are available, as well as the headboard can be fully covered with the same fabric or leather of the bed.

195x226 cm (140x200 cm)*
221x226 cm (160x200 cm)*
235x226 cm (170x200 cm)*
240x226 cm (180x200 cm)*

* Dimensioni del materasso /
Mattress sizes / Dimensions du
matelas / Abmessungen der
Matratze / Medidas del colchón

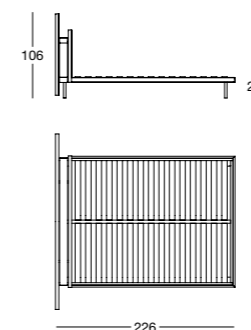

Lit

Pieds et étagère en acier recouverts en cuir sellier pigmentato 90. Structure en acier avec douves en hêtre courbé, verni naturel. Cadre et tête de lit rembourrés en polyuréthane/fibre polyester liée à chaud. Revêtement déhoussable en tissu ou en cuir. Sur demande, ils sont prévus les mesures pour des matelas de 210 cm. et 220 cm de longueur et il est possible de couvrir complètement le dos de la tête de lit avec le même tissu ou cuir que le lit.

Letto

Piedini e mensole in acciaio rivestiti in cuoio pigmentato 90. Struttura in acciaio con doghe in faggio curvato, verniciato naturale. Imbottitura testiera e base in poliuretano/fibra poliester termolegata. Rivestimento, sfilabile, in stoffa o pelle. A richiesta sono disponibili le misure per i materassi da 210 e 220 cm di lunghezza ed è possibile rivestire interamente il retro della testiera nel medesimo tessuto o pelle del letto.

Bed

Steel feet and shelves covered with cowhide pigmentato 90. Steel frame with suspension on natural bent beech strips. Base and headboard upholstered in polyurethane/heat bound polyester fibre. Removable fabric or leather cover. Upon request the bed sizes for 210 cm. and 220 cm. long mattresses are available, as well as the headboard can be fully covered with the same fabric or leather of the bed.

Letto

Piedini e mensole in acciaio rivestiti in cuoio pigmentato 90. Struttura in acciaio con doghe in faggio curvato, verniciato naturale. Imbottitura testiera e base in poliuretano/fibra poliester termolegata. Rivestimento, sfilabile, in stoffa o pelle. A richiesta sono disponibili le misure per i materassi da 210 e 220 cm di lunghezza ed è possibile rivestire interamente il retro della testiera nel medesimo tessuto o pelle del letto.

Bed

Steel feet and shelves covered with cowhide pigmentato 90. Steel frame with suspension on natural bent beech strips. Base and headboard upholstered in polyurethane/heat bound polyester fibre. Removable fabric or leather cover. Upon request the bed sizes for 210 cm. and 220 cm. long mattresses are available, as well as the headboard can be fully covered with the same fabric or leather of the bed.

Letto

Piedini e mensole in acciaio rivestiti in cuoio pigmentato 90. Struttura in acciaio con doghe in faggio curvato, verniciato naturale. Imbottitura testiera e base in poliuretano/fibra poliester termolegata. Rivestimento, sfilabile, in stoffa o pelle. A richiesta sono disponibili le misure per i materassi da 210 e 220 cm di lunghezza ed è possibile rivestire interamente il retro della testiera nel medesimo tessuto o pelle del letto.

Bed

Steel feet and shelves covered with cowhide pigmentato 90. Steel frame with suspension on natural bent beech strips. Base and headboard upholstered in polyurethane/heat bound polyester fibre. Removable fabric or leather cover. Upon request the bed sizes for 210 cm. and 220 cm. long mattresses are available, as well as the headboard can be fully covered with the same fabric or leather of the bed.

Struttura / Frame / Structure / Gestell / Estructura



Cuscini testiera / Headboard cushions / Coussins tête du lit / Kopfteil-Kissen / Cojines cabezal

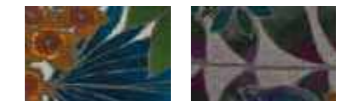

1 Henri Blu di Prussia

2 Henri Ametista

1865
Greg
Emaf Progetti
2002

Letto
Piedini in acciaio nichel satinato colore naturale o nero che permettono di ottenere diverse altezze del letto. Struttura smontabile in acciaio. Molleggio in doghe di faggio curvato con regolatori di rigidità. Le doghe sono montate su catene avvolgibili di nylon. Testiera e base imbottite in poliuretano/fibra poliestere termolegata. Rivestimento sfilabile in stoffa o in pelle. A richiesta è disponibile anche la misura per il materasso da 210 cm di lunghezza.

Bed
Steel feet, with natural or black nickel-satin finish, that allow different heights of the bed. Demountable steel frame. Suspension in bent beech strips with stiffness adjusters. The beech strips are mounted on roll-up nylon chains. Headboard and base upholstered in polyurethane/heat-bound polyester fibre. Removable fabric or leather cover. Upon request the bed size for 210 cm. long mattress is also available.



96x228 cm (90x200 cm)*
146x228 cm (140x200 cm)*
166x228 cm (160x200 cm)*
186x228 cm (180x200 cm)*
206x228 cm (200x200 cm)*

* Dimensioni del materasso /
Mattress sizes / Dimensions du
matelas / Abmessungen der
Matratze / Medidas del colchón

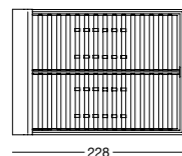

1858 / 1859
Greta
Roberto Lazzeroni
2018

Letti
Piedini in lega di alluminio verniciato colore grigio cenere o grigio antracite. Struttura in acciaio con doghe in faggio curvato (larghezza 6,8 cm), verniciato naturale. Imbottitura testiera in poliuretano/fibra poliestere termolegata. Rivestimento sfilabile in stoffa o pelle. A richiesta sono disponibili anche la misura per il materasso da 210 cm di lunghezza, la versione rete con doghe di larghezza 3,8 cm e il letto senza rete (1859).

Beds
Aluminium alloy feet painted in the shades ash-grey or anthracite grey. Steel frame with suspension on natural bent beech strips (6,8 cm wide). Headboard upholstered in polyurethane/heat-bound polyester fibre. Removable fabric or leather cover. Upon request the bed size for 210 cm long mattress, the springing with strips 3,8 cm. wide and the bed without springing (1859) are also available.

Lit
Petits pieds en acier nickel satiné, dans les couleurs naturel ou noir, que permettent d'obtenir différentes hauteurs du lit. Structure démontable en acier. Suspension en douves de hêtre courbé avec régulateurs de rigidité. Les douves sont montées sur chaines enroulables de nylon. Tête de lit et cadre rembourrés en polyuréthane/fibre polyester liée à chaud. Revêtement déhoussable en tissu ou en cuir. Sur demande, il est prévu aussi la mesure pour un matelas de 210 cm de longueur.

Bett
Füße aus Stahl, mit naturfarben- oder schwarz vernickeltem und mattiertem Finish, die verschiedene Betthöhen erlauben. Zerlegbares Gestell aus Stahl. Lattenrost aus gebogenen Buchen-Dauben, in der Nachgiebigkeit regulierbar. Die Dauben sind zusammenrollbar mit Nylon verkettet. Kopfteil und Untergestell- Polsterung aus Polyurethan/wärmegebundener Polyesterfaser. Abnehmbarer Bezug aus Stoff oder Leder. Auf Nachfrage ist die Bett-Maße für die Matratze 210 cm lang auch verfügbar.

Cama
Patatas de acero niquelado mate en los acabados natural o negro, que permiten de haber diferentes alturas de la cama. Estructura desmontable de acero. Somier con lamas de haya curvadas, con reguladores de rigidez. Las lamas estan montadas sobre cadenas de nylon enrollables. Cabezal y base acolchados de poliuretano/fibra poliéster termounida. Tapizado desenfundable de tejido o de piel. Sobre pedido está tambien disponible la medida de la cama para el colchón de 210 cm de largo.

Piedini / Feet / Pieds / Füße / Patas



1858 / 1859
Greta

162x220 cm (140x200 cm)*
182x220 cm (160x200 cm)*
192x220 cm (170x200 cm)*
202x220 cm (180x200 cm)*

* Dimensioni del materasso /
Mattress sizes / Dimensions du
matelas / Abmessungen der
Matratze / Medidas del colchón

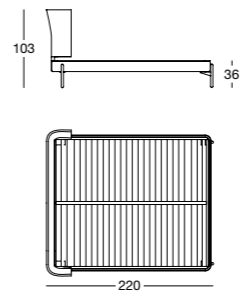

1885
Milano
De Pas, D'Urbino, Lomazzi
1982

Letto
Struttura in acciaio con doghe in faggio curvato. Piedini in acciaio nichelsatinato colore naturale o nero che permettono di ottenere diverse altezze del letto. Rivestimento sfilabile, in tessuto o pelle o non sfilabile in cuoio. La versione in cuoio ha le cuciture in filo bianco. A richiesta è disponibile anche la misura per il materasso da 210 cm di lunghezza.

Bed
Steel frame with bent beech strips. Steel feet, with natural or black nickel-satin finish that allow different heights of the bed. Removable fabric or leather cover, or non-removable in cowhide. The version in cowhide has the stitching in white thread. Upon request the bed size for 210 cm. long mattress is also available.

93x208 cm (90x200 cm)*
143x208 cm (140x200 cm)*
163x208 cm (160x200 cm)*
183x208 cm (180x200 cm)*
203x208 cm (200x200 cm)*

* Dimensioni del materasso /
Mattress sizes / Dimensions du
matelas / Abmessungen der
Matratze / Medidas del colchón

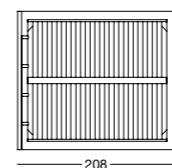

Cama
Estructura de acero con lamas de haya curvadas. Pies de acero niquelado mate en los acabados natural o negro que permiten diferentes alturas de la cama. Tapizado de tejido o de piel, desenfundable, o de cuero, fijo. La versión en cuero tiene las costuras en hilo blanco. Sobre pedido está tambien disponible la medida de la cama para el colchón de 210 cm de largo.

Piedini / Feet / Pieds / Füße / Patas



Lit
Structure en acier avec douves en hêtre courbé. Pieds en acier nickel satiné, dans les couleurs naturel ou noir que permettent d'obtenir différentes hauteurs du lit. Revêtement déhoussable, en tissu ou cuir ou non déhoussable en cuir sellier. La version en cuir sellier a les coutures en fil blanc. Sur demande, il est prévu aussi la mesure pour un matelas de 210 cm de longueur.

Bett
Stahlgestell mit Lattenrost aus gebogenen Buchen-Dauben. Füße aus Stahl mit naturfarben- oder schwarz- vernickeltem und mattiertem Finish, die verschiedene Betthöhen erlauben. Abnehmbarer Bezug aus Stoff oder Leder oder nicht abziehbares aus Kernleder. Die Nähte der Kernlederauführung sind weiß. Auf Nachfrage ist die Bett- Maße für die Matratze 210 cm lang auch verfügbar.

Camas
Patatas de aleación de aluminio pintado gris ceniza o gris antracita. Estructura de acero con lamas de haya curvada (ancho 6,8 cm), barnizado natural. Cabezal acolchado de poliuretano/fibra poliéster termounida. Tapizado desenfundable de tejido o de piel. Sobre pedido están tambien disponibles la medida de la cama para el colchón de 210 cm de largo, el somier con lamas de 3,8 cm. de ancho y la cama sin somier (1859).

Piedini / Feet / Pieds / Füße / Patas



1603
Milleunanotte
Emaf Progetti
2006

Letto con struttura a baldacchino
Struttura smontabile in legno impiallacciato in rovere verniciato naturale o tinto grigio. Molleggio in doghe di faggio curvato, con regolatori di rigidità. Testiera imbottita in poliuretano/fibra poliestere termolegata. Rivestimento sfilabile in stoffa o in pelle. A richiesta è disponibile anche la misura per il materasso da 210 cm di lunghezza.

Four-poster bed with canopy
Demountable wooden frame either veneered with natural or grey vanished oak. Suspension in bent beech strips, with stiffness adjusters. Headboard upholstered in polyurethane/heat-bound polyester fibre. Removable fabric or leather cover. Upon request the bed size for 210 cm. long mattress is also available.

Lit avec structure à baldaquin
Structure démontable, en bois contreplaqué en rouvre, couleur naturelle ou teinté gris. Suspension en douves de hêtre courbé, couleur naturelle, avec régulateurs de rigidité. Tête de lit rembourrée en polyuréthane/fibre polyester liée à chaud. Revêtement déhoussable en tissu ou en cuir. Sur demande, il est prévu aussi la mesure pour un matelas de 210 cm de longueur.

Himmelbett
Zerlegbares Gestell aus Holz, mit naturfarben oder grau-gebeizter Eiche furniert. Lattenrost aus gebogenen Buchen-Dauben, in der Nachgiebigkeit regulierbar. Kopfteil-Polsterung aus Polyurethan/wärmegebundener Polyesterfaser. Abnehmbarer Bezug aus Stoff oder Leder. Auf Nachfrage ist die Bett-Maße für die Matratze 210 cm lang auch verfügbar.

Cama con dosel
Estructura desmontable de madera contrachapada de roble pintado natural o teñido gris. Suspensión en lamas de haya curvadas, con reguladores de rigidez. Cabezal acolchado de poliuretano/fibra poliéster termounida. Tapizado desenfundable de tejido o de piel. Sobre pedido está tambien disponible la medida de la cama para el colchón de 210 cm de largo.

Rovere naturale
Natural oakwood
Rouvre naturel
Naturfarbene Eiche
Roble natural

Rovere tinto grigio
Grey varnished oak
Rouvre teinté gris
Grau-gebeizte Eiche
Roble teñido gris

1603
Milleunanotte

(160x200 cm)*
(170x200 cm)*

* Dimensioni del materasso /
Mattress sizes / Dimensions du
matelas / Abmessungen der
Matratze / Medidas del colchón

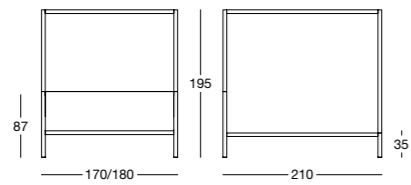

1706 / 1707

Nyx
Emaf Progetti
2010

Letto

Struttura smontabile in acciaio verniciato, colore nero o bianco. Molleggio in doghe di faggio curvato con regolatori di rigidità. La versione 1707 è dotata di cuscini testiera in piuma d'oca – materiale 100% vergine con inserto in poliuretano. Rivestimento sfilabile in stoffa o pelle. A richiesta è disponibile anche la misura per il materasso da 210 cm di lunghezza.

Bed

Demountable steel frame painted in the shade of black or white. Springing in bent beech strips, with stiffness adjusters. Version 1707 has headboard cushions with goose down – 100% pure material, with polyurethane insert. Removable fabric or leather cover. Upon request the bed size for 210 cm. long mattress is also available.

Lit

Structure démontable en acier laqué, noire ou blanche. Suspension en douves de hêtre courbé, avec régulateurs de rigidité. Dans la version 1707, les coussins à la tête du lit sont en plumes d'oie – matériau 100 % vierge, avec insert en polyuréthane. Revêtement déhoussable en tissu ou en cuir. Sur demande, il est prévu aussi la mesure pour un matelas de 210 cm de longueur.

Bett

Zerlegbares Gestell aus weiß oder schwarz lackiertem Stahl. Lattenrost aus gebogenen Buchen-Dauben, in der Nachgiebigkeit regulierbar. Bei der Ausführung 1707 sind die Kissen des Kopfteils mit 100% reinen Gänsedaunen gefüllt, mit Einlage aus Polyurethan. Abnehmbarer Bezug aus Stoff oder Leder. Auf Nachfrage ist die Bett-Maße für die Matratze 210 cm lang auch verfügbar.

Cama

Estructura desmontable de acero barnizado, color negro o blanco. Somier con lammas de haya curvadas, con reguladores de rigidez. La versión 1707 está dotada de cojines de cabezal en plumón de ganso – material 100% virgen con inserción de poliuretano. Tapizado desenfundable en tejido o piel. Sobre pedido está también disponible la medida de la cama para el colchón de 210 cm de largo.

Struttura / Frame / Structure / Gestell / Estructura



Mod. 1706

96x206 cm (90x200 cm)*
146x206 cm (140x200 cm)*
166x206 cm (160x200 cm)*
186x206 cm (180x200 cm)*
206x206 cm (200x200 cm)*

Mod. 1707

96x218 cm (90x200 cm)*
146x218 cm (140x200 cm)*
166x218 cm (160x200 cm)*
186x218 cm (180x200 cm)*
206x218 cm (200x200 cm)*

* Dimensioni del materasso /
Mattress sizes / Dimensions du
matelas / Abmessungen der
Matratze / Medidas del colchón

1706

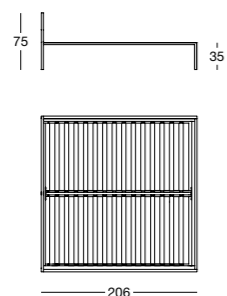

1707

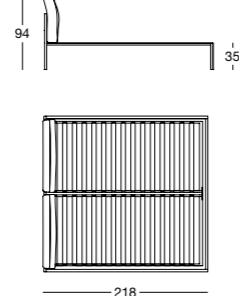

1862
Ricordi

Spalvieri & Del Ciotto
2020

Letto

Struttura testiera in rovere naturale o verniciato a poro aperto colore nero. Imbottitura in poliuretano/fibra poliestere termolegata. Piedi anteriori e asta superiore testiera in acciaio verniciato colore nero opaco. Rivestimento sfilabile in stoffa o pelle. Struttura base in acciaio con doghe in faggio curvato (larghezza 6,8 cm), verniciato naturale. A richiesta è disponibile anche la misura per il materasso da 210 cm di lunghezza e la versione rete con doghe di larghezza 3,8 cm.

Bed

Headboard frame in natural or in black open pore painted oak. Upholstery in polyurethane/heat-bound polyester fibre. Front feet and headboard upper rod in matt black varnished steel. Removable fabric or leather cover. Steel base with natural bent beech strips (6,8 cm wide). Upon request the bed size for 210 cm long mattress as well as the springing with strips 3,8 cm. wide, are available.

Lit

Structure tête et pied du lit en rouvre naturel ou verni à pore ouvert, dans la couleur noire. Rembourrage en polyuréthane/fibre polyester liée à chaud. Pieds avant et tige supérieure en acier peint en noir mat. Revêtement déhoussable en tissu ou en cuir. Structure en acier avec douves en hêtre courbé (largeur 6,8 cm), verni naturel. Sur demande il est possible de commander le lit pour le matelas longueur de 210 cm et le sommier avec douves 3,8 cm. large.

1862
Ricordi

173x215 cm (160x200)*
183x215 cm (170x200)*
193x215 cm (180x200)*

* Dimensioni del materasso /
Mattress sizes / Dimensions du
matelas / Abmessungen der
Matratze / Medidas del colchón

Bett

Kopfteil aus naturfarbener oder schwarz lasierter Eiche. Polsterung aus Polyurethan/wärmegebundener Polyesterfaser. Vordere Füße und obere Stange des Kopfteils aus mattem schwarz lackiertem Stahl. Abnehmbarer Bezug aus Stoff oder Leder. Unterteil-Gestell aus Stahl mit Lattenrost aus gebogenen Buchen-Dauben (Breite 6,8 cm.), naturfarben lackiert. Auf Nachfrage sind die Bett-Maße für die Matratze 210 cm lang und die Dauben mit einer Breite von 3,8 cm verfügbar.

Cama

Estructura cabezal y pies en roble natural o lacado a poro abierto color negro. Acolchado de poliuretano/ fibra de poliéster termounida. Patas anteriores y varilla superior del cabezal en acero pintado color negro mate. Tapizado desenfundable de tejido o piel. Estructura de acero con lammas de haya curvada (ancho 6,8 cm), barnizado natural. Sobre pedido la cama puede realizarse para alojar un colchón de 210 cm de largo y el somier puede ser con lammas de 3,8 cm. de ancho.

Struttura / Frame / Structure / Gestell / Estructura

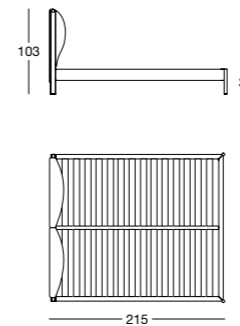

1883 / 1884

Talamo
Damian Williamson
2011

Letti

Piedini in lega di alluminio lucidato o nichelsatinato colore naturale o nero, oppure verniciato nero. Struttura in acciaio con doghe in faggio curvato. Imbottitura testiera in poliuretano/fibra poliestere termolegata. Rivestimento sfilabile in stoffa o pelle. A richiesta sono disponibili anche le misure per i materassi da 210 e 220 cm di lunghezza.

Lits

Pieds en alliage d'aluminium poli ou nickel satiné, dans les couleurs naturel ou noir, ou verni noir. Structure en acier avec douves en hêtre courbé. Rembourrage de la tête de lit en polyuréthane/fibre polyester liée à chaud. Revêtement déhoussable en tissu ou en cuir. Sur demande, ils sont prévus aussi les mesures pour des matelas de 210 cm. ou 220 cm. de longueur.

Camas

Pies de aleación de aluminio pulido o niquelado mate en los acabados natural o negro, o pintado negro. Estructura de acero con lammas de haya curvada. Cabezal acolchado de poliuretano/fibra poliéster termounida. Tapizado desenfundable, de tejido o de piel. Sobre pedido están también disponibles las medidas de la cama para colchones de 210 cm y 220 cm de largo.

Beds

Polished or black painted aluminium alloy feet, or with natural or black nickel-satin finish. Steel frame with suspension in bent beech strips. Headboard upholstered with polyurethane/heat-bound polyester fibre. Removable fabric or leather cover. Upon request the bed sizes for 210 cm. and 220 cm. long mattresses are also available.

Betten

Füße aus polierter oder schwarz-lackierter Aluminiumlegierung oder mit naturfarben- oder schwarz- vernickeltem oder mattiertem Finish. Stahlgestell mit gebogenen Buchen-Dauben. Kopfteilpolsterung aus Polyurethan/wärmegebundener Polyesterfaser. Abnehmbarer Bezug aus Stoff oder Leder. Auf Nachfrage sind die Bett-Maßen für die Matratzen 210 cm und 220 cm lang auch verfügbar.

Piedini / Feet / Pieds / Füße / Patas



166x216 cm (160x200 cm)*
176x216 cm (170x200 cm)*
186x216 cm (180x200 cm)*
206x216 cm (200x200 cm)*

* Dimensioni del materasso /
Mattress sizes / Dimensions du
matelas / Abmessungen der
Matratze / Medidas del colchón

1883
piedino h. 17,5 cm
foot h. 17,5 cm
pied h. 17,5 cm
Fuß h. 17,5 cm
pie h. 17,5 cm

1884
piedino h. 27,5 cm
foot h. 27,5 cm
pied h. 27,5 cm
Fuß h. 27,5 cm
pie h. 27,5 cm

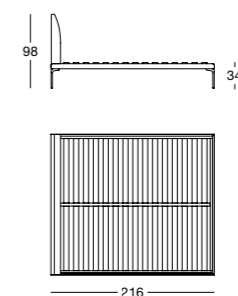
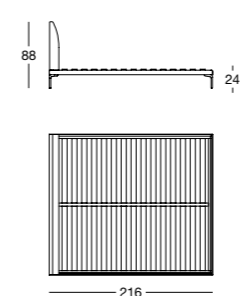

1890 / 1891
Confortevole
 h 20 cm / h 30 cm

Materasso a molle insacchettate con automodellante
 Pocket sprung mattress with memory foam
 Matelas à ressorts ensachés avec auto-moulant
 Selbstmodellierende Matratze mit Taschenfedern
 Colchón de muelles ensacados con auto-amoldante

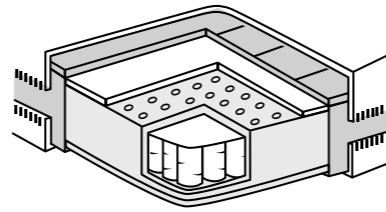

1889
Formaplus

Materasso automodellante
 Memory foam mattress
 Matelas auto-moulant
 Selbstmodellierende Matratze
 Colchón auto-amoldante

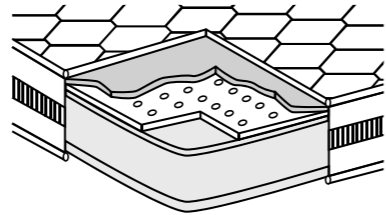

1887
Mollaplus

Materasso a molle insacchettate
 Pocket sprung mattress
 Matelas à ressorts ensachés
 Matratze mit Taschenfedern
 Colchón de muelles ensacados

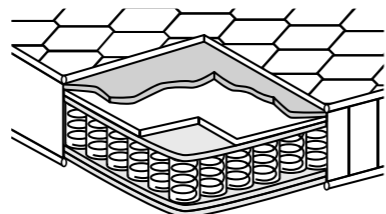

1886
Molleggio

Materasso a molle
 Spring mattress
 Matelas à ressorts
 Matratze mit Stahlfedern
 Colchón de muelles

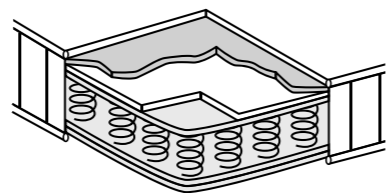

1893
Natura

Materasso in lattice
 Latex mattress
 Matelas en latex
 Latex-Matratze
 Colchón de látex

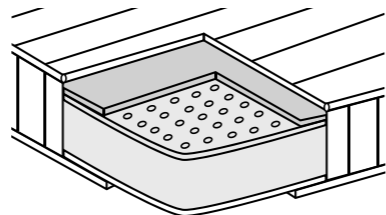

1898
Topper

Materassino aggiuntivo per materassi
 Mattress topper
 Petit matelas d'appoint pour matelas
 Matratzenauflage für normale Matratzen
 Colchoncillo adicional para colchones

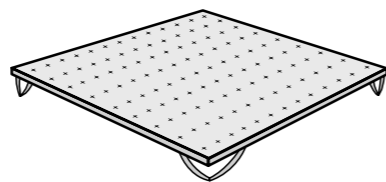

1896
Pisolo

A
 Guanciaie in Hollofil
 Hollofil pillow
 Oreiller en Hollofil
 Hollofil Kissen
 Almohada de Hollofil

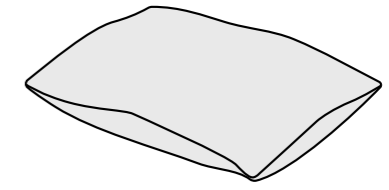

B
 Guanciaie in piuma
 Feather pillow
 Oreiller en plume
 Daunenkissen
 Almohada de pluma

C
 Guanciaie automodellante cervicale
 Wave-shaped memory foam pillow
 Oreiller auto-moulante à deux ondes
 Selbstmodellierendes Kissen mit zwei Erhebungen
 Almohada auto-amoldante con doble ola

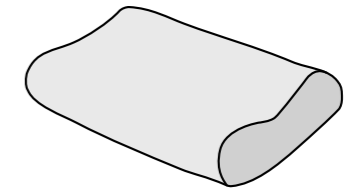

D
 Guanciaie in lattice cervicale
 Wave-shaped latex pillow
 Oreiller en latex à deux ondes
 Kissen aus Latex mit zwei Erhebungen
 Almohada de látex con doble ola

E
 Guanciaie in lana
 Wool pillow
 Oreiller en laine
 Kissen aus Wolle
 Almohada de lana

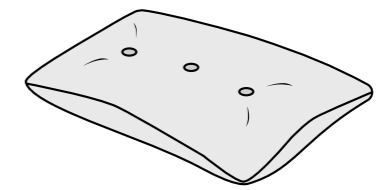

F
 Guanciaie automodellante saponetta
 Soap-shaped memory foam pillow
 Oreiller auto-moulante en forme de savon
 Selbstmodellierendes Kissen seifenförmig
 Almohada auto-amoldante de forma tradicional

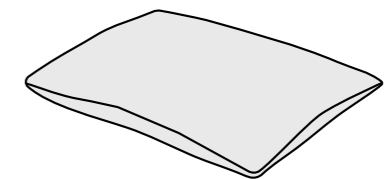

Complementi d'arredo
Furnishing accessories
Compléments d'ameublement
Wohnaccessoires
Complementos de decoración

400
Albero
Achille Castiglioni
1983

Portavasi smontabile
Struttura in acciaio verniciato nei colori bianco, nero, amaranto o verde. Piattelli portavasi in poliammide, colore nero. Piedini in polipropilene colore nero.

Demountable flowerpot stand
Painted steel frame in the shades black, white, amaranth or green. Pot-holder dishes in black polyamide. Black polypropylene feet.

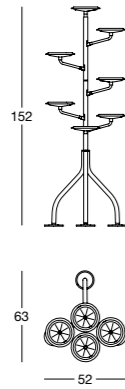

Jardinière démontable
Structure en acier verni dans les couleurs blanc, noir, amarante ou vert. Petits plats en polyamide, couleur noire. Pieds en polypropylène noir.

Zerlegbarer Blumenständer
Gestell aus lackiertem Stahl, in den Farben weiß, schwarz, Amaranthrot oder grün. Polyamid-Untersetzer, schwarzfarben. Füße aus schwarzem Polypropylen.

Porta-macetas desmontable
Estructura en acero pintado en los colores blanco, negro, granate o verde. Platos porta-macetas en poliamida color negro. Patas en polipropileno negro.

Struttura / Frame / Structure / Gestell / Estructura



340
Chichibio
G. Levi Montalcini,
G. Pagano Pogatschnig,
1932

Portaoggetti / portatelefono
Struttura in tubo di acciaio cromato. Pianetti in laminato plastico stratificato, colore bianco/nero.

Objects / telephone stand
Chromium-plated, tubular steel frame. Shelves in white/black colour, layered plastic laminate.



Porte-objets / porte-téléphone
Structure en tube d'acier chromé. Plateaux en laminé plastique stratifié, couleur blanche/noire.

Ständer für Gegenstände oder fürs Telefon
Gestell aus verchromtem Stahlrohr. Platten aus Schichtpress-Stoff Laminat, weiß/schwarz.

Porta objetos / porta teléfono
Estructura tubular de acero cromado. Estantes de laminado plástico estratificado, color blanco / negro.

Pianetti / Shelves / Plateaux / Platten / Estantes



230
Allunaggio
Achille e Pier Giacomo
Castiglioni
1965

IN / OUT

Sedile per esterni
Gambe in acciaio, sedile in lega di alluminio, verniciati colore verde prato. Piedini in polietilene, colore naturale.

Outdoor stool
Steel legs, aluminium alloy seat painted grass green. Natural polyethylene feet.

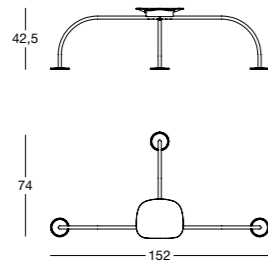

Siège pour extérieurs
Pieds en acier, siège en alliage d'aluminium, vernis vert pré. Pieds en polyéthylène, couleur naturelle.

Stuhl fürs Freie
Beine aus Stahl, Sitz aus Aluminiumlegierung, grasgrün lackiert. Fußenden aus naturfarbenem Polyäthylen.

Taburete para exteriores
Patas de acero, asiento de aleación de aluminio, pintados de color verde Prado. Pies de polietileno de color natural.

100
Follia
Giuseppe Terragni
1934

Poltroncina
Sedile e schienale colore nero. Balestre di sostegno schienale in acciaio inox 18/8.

Chair
Black seat and back. 18/8 stainless steel backrest support spring.

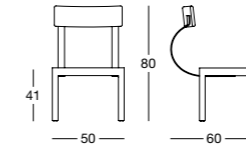

Petit fauteuil
Siège et dossier couleur noire. Ressort de soutien en acier inox 18/8.

Stuhl
Sitzfläche und Rückenlehne schwarz. Federbogen der Rückenlehne aus Inox- Stahl 18/8.

Butaquita
Asiento y respaldo de color negro. Elementos de soporte respaldo de acero inox 18/8.

303
Aster
Alessandro Dubini
2010

Appendiabiti
Struttura in acciaio verniciato, colore bianco, nero o rosso.

Clothes stand
Steel frame painted white, black or red.

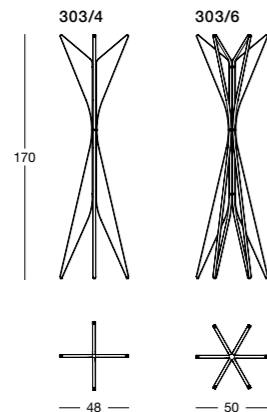

Portemanteaux
Structure en acier verni blanche, noire ou rouge.

Kleiderständer
Gestell aus weiß, schwarz oder rot lackiertem Stahl.

Colgador
Estructura de acero barnizado de color blanco, negro o rojo.

Struttura / Frame / Structure / Gestell / Estructura



250
Giotto
De Pas, D'Urbino, Lomazzi
1975

Sgabello
Struttura in faggio, colore naturale, con crociera rossa. Sedile girevole e regolabile in altezza.

Stool
Natural varnished beech frame with red bracket. Vertically adjustable revolving seat.



Tabouret
Structure en hêtre naturel avec croisillon rouge. Assise tournante et réglable en hauteur.

Hocker
Struktur aus Buche, naturfarben, mit rotem Kreuz. Drehbarer Sitz, höhenverstellbar.

Taburete
Estructura de haya natural con cruceta en rojo. Asiento giratorio y regulable en altura.

712
Joy
Achille Castiglioni
1989

Mobile a ripiani rotanti
Piani in medium density fiberboard, verniciatura gofrata antigraffio nei colori bianco, nero o bordeaux. Snodi portanti in acciaio verniciato nero nelle versioni nera o bordeaux oppure bianco nella versione bianca. Il mobile è disponibile nella versione a cinque o a sette ripiani.

Rotating shelf unit
Uprights and shelves in medium density fiberboard, finished with scratch-resistant embossing in white, black or burgundy. Steel articulated joints painted black for the models black or burgundy, or in the shade white for the white model. The shelf unit is available with either five or seven shelves.

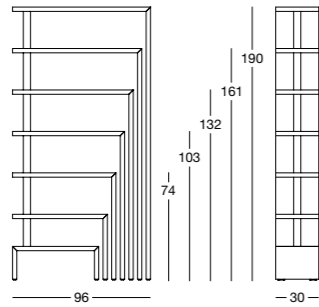

Meuble à étagères pivotantes
Éléments en medium density fiberboard avec vernissage gaufré antirayures dans les couleurs blanc, noir ou bordeaux. Articulations porteuses en acier verni noir dans les versions noire ou bordeaux ou verni blanc pour la version blanche. Le meuble est disponible dans la version avec cinq ou sept étagères.

Drehregal
Platten aus Medium Density Fiberboard, kratzfest gaufriert lackiert in den Farben weiß, schwarz oder burgunderrot. Gelenk-Stützen aus schwarz lackiertem Stahl für die Modelle in den Farben schwarz oder burgunderrot; oder weiß lackiert für die weiße Version. Das Drehregal ist in zwei Versionen lieferbar, bzw. mit fünf oder sieben Platten.

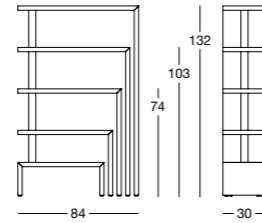

Mueble con estantes giratorios
Estantes de MDF lacado en relieve anti-rasguño en los colores blanco, negro o burdeos. Articulaciones portantes de acero pintado negro por las versiones en negro o burdeos, o blanco por la versión en blanco. El mueble está disponible con cinco o siete estantes.

Snodo / Articulated joint / Articulation / Verbindungsstück / Articulación

Pianetti / Shelves / Plateaux / Platten / Estantes

220
Mezzadro
Achille e Pier Giacomo Castiglioni
1957

Sgabello
Gambo in acciaio cromato. Sedile verniciato nei colori: arancio, rosso, giallo, bianco o nero. Base in faggio evaporato, colore naturale.

Stool
Chromium-plated steel stem. Seat lacquered in the colours: orange, red, yellow, white or black. Footrest in steam-treated beech, natural colour.

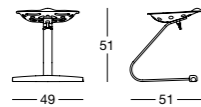

Tabouret
Pied en acier chromé. Siège verni dans les couleurs: orange, rouge, jaune, blanc ou noir. Base en hêtre évaporé, couleur naturelle.

Hocker
Stützstange aus verchromtem Stahl. Sitz lackiert orange, rot, gelb, weiß oder schwarz. Fuß aus gedampfter Buche, naturfarben.



Taburete
Pata de acero cromado. Asiento pintado en los colores: rojo, naranja, amarillo, blanco o negro. Base de haya vaporizada, color natural.

465
Milo CM
Ormaggio a Carlo Mollino
1938

Specchio
Silhouette della Venere di Milo in cristallo con nottolino in acciaio inox per il fissaggio a parete.

Mirror
Venus de Milo's silhouette plate glass, with stainless steel pawl for hanging.



Miroir
Silhouette de la Venus de Milo en verre avec attache en acier inox pour l'accrochage au mur.

Spiegel
Silhouette der Venus von Milo aus Kristallglas. Aufhängung aus Inox-Stahl.

Espejo
Silueta de la Venus de Milo de cristal con pletinas de acero inox para colgar el espejo a la pared.

310
Museo
Enzo Mari
1991

Appendiabiti a muro
Elemento singolo in acciaio verniciato antigraffio, colore nero o bianco.

Coat hanger
Single steel element, painted black or white with scratch resistant finish.

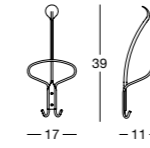

Porte-manteaux a mur
Élément single en acier verni antirayures, couleur noire ou blanche.

Wandgarderobe
Einzel Element aus Stahl mit Anti-Kratzer-Lackierung, Farbe schwarz oder weiß.



460
Pablo
Gabriele Rosa
2008

Specchio
Cristalli sovrapposti e incollati, predisposti per il fissaggio orizzontale o verticale a parete, tramite nottolini in acciaio inox saldati direttamente sui cristalli.

Mirror
Panels of glass overlapped and bounded, ready to be mounted on the wall either horizontally or vertically using stainless steel ratchets welded directly onto the glass.

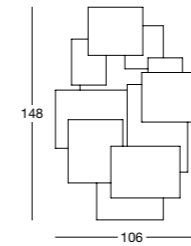

Miroir
Cristaux superposés et collés, prepares pour la fixation horizontale ou verticale au mur à l'aide de cliquets en acier inox soudés directement sur les cristaux.

Spiegel
Glasscheiben überlappt und verklebt, vorbereitet zur horizontalen oder vertikalen Befestigung an der Wand mittels Sperrzähnen aus Inoxstahl, die direkt auf die Glasscheiben geschweißt sind.

Espejo
Cristales sobrepuestos y pegados, predispuestos para fijación horizontal o vertical en la pared, a través de aldabillas de acero inoxidable soldadas directamente en los cristales.

240
Primate
Achille Castiglioni
1970

Sedile inginocchiatoio
Struttura in poliuretano rigido. Basamento in polistirolo, colore nero. Imbottitura in poliuretano flessibile. Gambo in acciaio inox 18/8. Rivestimento in Ecofire o pelle 95.

Kneeling-stool
Stiff polyurethane frame. Base in black painted polystyrene. Flexible polyurethane upholstery. 18/8 stainless steel leg. Cover in Ecofire or leather 95.

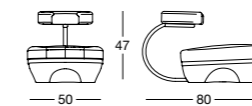

Siège-agenouilloir
Structure en polyuréthane rigide. Embase en polystyrène, couleur noire. Rembourrage en polyuréthane flexible. Tige en acier inox 18/8. Revêtement en Ecofire ou cuir 95.

Kniesitz
Gestell aus steifem Polyurethan. Basis aus schwarzem Polystyrol. Polsterung aus flexiblem Polyurethan. Stützstange aus Inox-Stahl 18/8. Bezug aus Ecofire oder Leder 95.

Asiento ergonómico
Estructura de poliuretano rígido. Base de poliestirol, de color negro. Acolchado de poliuretano flexible. Elemento de soporte asiento de acero inox 18/8. Tapizado en Ecofire o piel 95.

471
Raperonzolo
Atelier Oi
2015

Specchio
Superficie in cristallo. Il bordo dello specchio è in cuoio intrecciato colore gold accoppiato ad Alcantara® nei colori gold, blu e viola. Il fissaggio a parete è realizzato con una piastra in metallo bronzato.

Mirror
Plate glass surface. The mirror outline is made of cowhide in the shade of gold, interwoven with Alcantara® in the shades gold, blue and violet. Wall fastening by means of a bronzed metal plate.

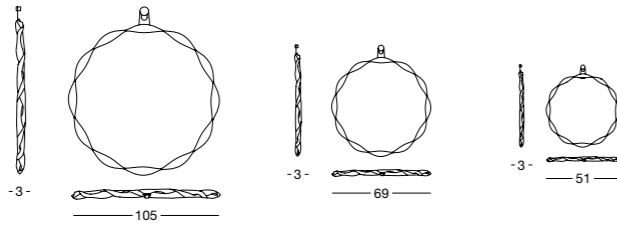

Miroir
Surface en cristal. Le bord du miroir est en cuir sellier tressé dans la couleur gold couplé au Alcantara® dans les couleurs gold, bleu et violet. L'accrochage au mur est prévu à travers une plaque en métal bronzée.

Spiegel
Fläche aus Glasscheiben. Der Spiegel ist mit einem Zopf aus goldfarbenen Kernlederbänder umfasst, welche mit Alcantara® bzw. in den Farben Gold, Blau und Veilchen geflochten werden. Befestigung an der Wand mittels einer Platte aus bronziertem Metall.

Espejo
Superficie en cristal. El borde del espejo es en cuero trenzado en color gold acoplado con Alcantara® en los colores gold, azul y morado. Para colgar el espejo a la pared está prevista una placa en metal bronceado.

300
Sciangai
De Pas, D'Urbino, Lomazzi
1973

Appendiabiti chiudibile Struttura in frassino tinto rovere, tinto grigio, bianco, nero o bordeaux.

Folding clothes stand
Frame in oak, grey, white, black or burgundy varnished ash.

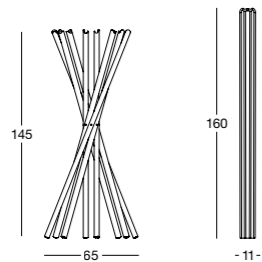

Portemanteaux pliant Structure en frêne teinté rouvre, teinté gris, blanc, noir ou bordeaux.

Zusammenfaltbarer Kleiderständer
Gestell aus Eiche, grau, weiß, schwarz oder burgunderrot gebeiztem Eschenholz.

Perchero plegable
Estructura de fresno teñido roble, gris, blanco, negro o burdeos.



200
Sella
Achille e Pier Giacomo Castiglioni
1957

Sedile
Sella di bicicletta da corsa, colore nero, asta in acciaio verniciato, colore rosa. Basamento in fusione di ghisa.

Seat
Black saddle of racing bicycle, pink lacquered steel column. Cast-iron base.

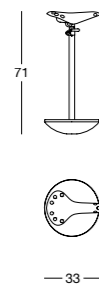

Siège
Selle de bicyclette de course couleur noire. Tige en acier verni couleur rose. Base en fonte.

Sitz
Rennradsattel Farbe schwarz. Stützstange aus lackiertem Stahl, rosa. Fuß aus Gusseisen.

Taburete
Sillín de bicicleta de carrera de color negro, vástago de acero pintado de rosa. Base en hierro fundido.

527
Servento
Achille Castiglioni della serie Servi di Achille & Pier Giacomo Castiglioni
1986

Paravento
Base in polipropilene verniciato nero, bianco o rosso. Asta di sostegno in acciaio verniciato, colore nero, bianco o rosso. Telo in panno di lana, misure cm 66 x 150, nei colori: grigio chiaro, grigio medio, grigio scuro, rosso, giallo, carta da zucchero, mattone, verde chiaro, verde scuro o viola.

Screen
Base in black, white or red painted polypropylene. Steel support rod, painted in the shade black, white or red. Wool canvas screen, sizes cm 66 x 150, in the shades: light grey, medium grey, dark grey, red, yellow, powder blue, brick, light green, dark green or purple.

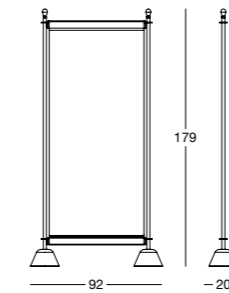

Paravent
Base en polypropylène verni noir, blanc ou rouge. Tige de soutien en acier verni, noir, blanc ou rouge. Toile en tissu de laine, mesure 66 x 150 cm, dans les couleurs: gris clair, gris moyen, gris foncé, rouge, jaune, bleu poudre, brique, vert clair, vert foncé ou violet.

Paravent
Fuß aus schwarz, weiß oder rot lackiertem Polypropylen. Stange aus lackiertem Stahl, in den Farben schwarz, weiß oder rot. Leinwand aus Wolle, Maße 66 x 150 cm, in den Farben: hellgrau, mittelgrau, dunkelgrau, rot, gelb, taubenblau, Backstein, hellgrün, dunkelgrün oder Veilchen.

Separador de ambiente
Base de polipropileno pintado negro, blanco o rojo. Asta de soporte de acero pintado, negro, blanco o rojo. Panel en tejido de lana, medida 66 x 150 cm, en los colores: gris claro, gris medio, gris obscuro, rojo, amarillo, azul polvo, ladrillo, verde claro, verde oscuro o púrpura.

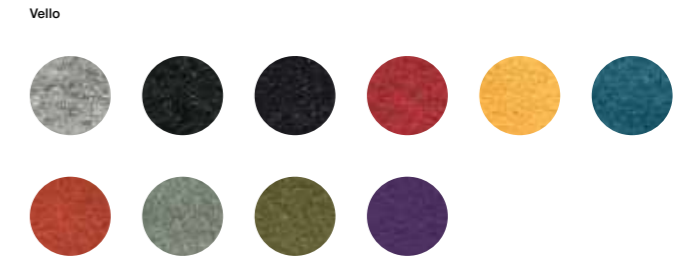

350 / 355
Servonotte Servietto
Achille Castiglioni della serie Servi di Achille & Pier Giacomo Castiglioni
1986

Portabito da camera / portasciugamani da bagno
Base in polipropilene e struttura verniciata in acciaio, colore nero o bianco.

Bedroom clothes-stand / bathroom towel-rack
Polypropylene base and steel frame, painted in the colours: black or white.

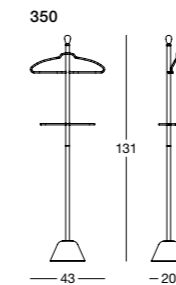

Valet de chambre / porte-serviettes
Base en polypropylène et structure en acier verni, couleur noire ou blanche.

Stummer Diener / Handtuchträger
Fuß aus Polypropylen und Gestell aus lackiertem Stahl, schwarz oder weiß.

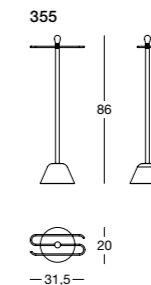

Galán de noche / porta toallas de baño
Base de polipropileno y estructura de acero pintado en los colores: negro o blanco.



515
Servobandiera
 Achille Castiglioni
 della serie Servi
 di Achille & Pier Giacomo
 Castiglioni
 1986

IN / OUT

Portabandiera
 Base in polipropilene verniciato nero. Asta di sostegno in acciaio verniciato, colore nero per esterni. Bandiera in stamigna di lana. Colori, simboli e misure da capitolato. Misura del drappo cm 100 x 150. La bandiera svizzera misura cm 100 x 100. I simboli delle bandiere statunitensi e Consiglio d'Europa sono ricamati. Disponibile anche la sola base e asta senza drappo.

Flag-holder
 Base in black painted polypropylene. Steel support rod, in the shade black for outdoor. Bunting flag. Regulation colours, symbols and sizes. Flag size cm 100 x 150, Swiss flag cm 100 x 100. On the USA and Council of Europe flags, the symbols are embroidered. Base and support rod, without cloth, are available separately.

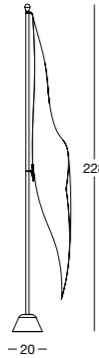

Porte-étendard
 Base en polypropylène verni noir. Tige de soutien en acier verni couleur noire pour extérieurs. Drapeau en étamine de laine. Couleurs, symbols et mesures suivant cahier de charges. Dimensions du drapeau cm 100 x 150. Le drapeau suisse mesure cm 100 x 100. Les symbols des drapeaux américain et du Conseil d'Europe sont brodés. Nous pouvons fournir la base et la tige de soutien, sans le drapeau.

Fahnenständer
 Fuß aus Polypropylen, schwarz lackiert. Stange aus Stahl, schwarz lackiert fürs Freie. Fahne aus Wolletamin. Genormte Farben, Symbole und Maße. Maße 100 x 150 cm. Maße der Schweizer Fahne 100 x 100 cm. Die Symbole Europarats und der USA sind aufgestickt. Fuß und Stange auch ohne Fahne lieferbar.

Portabandera
 Base de polipropileno pintado negro. Asta de acero pintado de negro para exteriores. Bandera de lana. Colores, símbolos y medidas según las normas. Medidas de la bandera 100 x 150 cm. La bandera suiza mide 100 x 100 cm. Los símbolos de las banderas estadounidense y del Consejo de Europa están bordados. También suministramos solamente la base y el asta, sin bandera.

305
Servomanto
 Achille Castiglioni
 della serie Servi
 di Achille & Pier Giacomo
 Castiglioni
 1985

Appendiabiti
 Base in polipropilene verniciato nero o bianco. Asta di sostegno e bracci appendiabiti in acciaio verniciato, colore nero o bianco.

Clothes stand
 Base in black or white painted polypropylene. Support rod and arms in black or white painted steel.

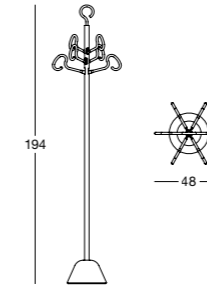

Portemanteaux
 Base en polypropylène verni noir ou blanc. Tige de soutien et bras en acier verni noir ou blanc.

Kleiderständer
 Fuß aus Polypropylen, schwarz oder weiß lackiert. Stützstange und Arme aus schwarz oder weiß lackiertem Stahl.



Perchero
 Base de polipropileno pintado negro o blanco. Estructura de acero pintado, color negro o blanco.

525
Servostop
 Achille Castiglioni
 della serie Servi
 di Achille & Pier Giacomo
 Castiglioni
 1984

Transenna
 Base in polipropilene verniciato nero. Asta di sostegno con gancio in acciaio verniciato, colore nero. Catena in acciaio verniciato rosso.

Partition system
 Base in black painted polypropylene. Black painted steel support rod with hook. Red painted steel chain.

Transenne
 Base en polypropylène verni noir. Tige de soutien avec crochet en acier verni noir. Chaîne en acier verni rouge.

Absperrsystem
 Fuß aus Polypropylen, schwarz lackiert. Stange mit Haken aus schwarz lackiertem Stahl. Kette aus rot lackiertem Stahl.

Catenaria
 Base de polipropileno pintado negro. Asta de soporte con gancho de acero pintado de negro. Cadena de acero barnizado rojo.

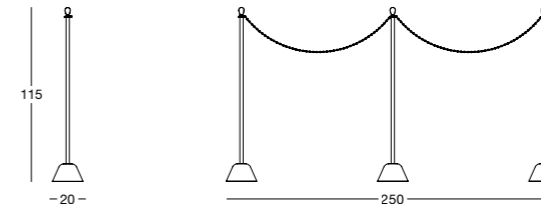

370 / 380
Servofumo
Servopluvio
 Achille e Pier Giacomo
 Castiglioni
 1961

IN / OUT

Portacenere / portaombrelli
 Base in polipropilene, vaschetta in alluminio e struttura di sostegno in acciaio verniciato, colore nero per esterni.

Ash-tray / umbrella stand
 Base in polypropylene, container in aluminium and steel support frame, black painted for outdoor.

Cendrier / porte-parapluies
 Base en polypropylène, bassinnet en aluminium et structure de soutien en acier verni couleur noire pour extérieurs.

Standascher / Regenschirmständer
 Fuß aus Polypropylen, Behälter aus Aluminium und tragendes Gestell aus lackiertem Stahl, schwarzfarben fürs Freie.

Cenicero / paragüero
 Base de polipropileno, cubeta de aluminio y estructura de acero pintado, color negro para exteriores.

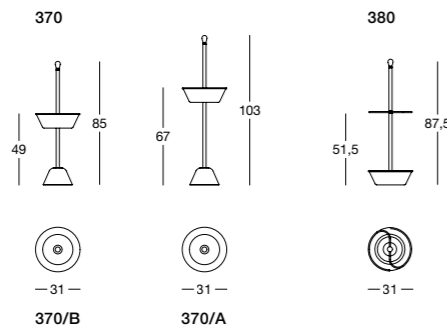

5701
Veryound
 Louise Campbell
 2006

Seduta
 Struttura in lamiera di acciaio, tagliata con laser tridimensionale, verniciata colore bianco.

Seat
 Steel sheet frame cut by three-dimensional laser, varnished in the colour white.

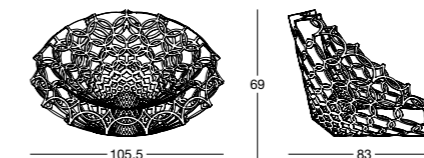

Siège
 Structure en tôle d'acier, découpée au laser tridimensionnel, verni couleur blanc.

Sitz
 Stahlblech Gestell, mit Drei-dimensional Laser geschnitten, lackiert weißfarben.

Asiento
 Estructura de chapa de acero, cortada con láser tridimensional, pintada color blanco.

**Finiture
Finishes
Finitions
Finish
Acabados**

Verniciatura gofrata legno
Wood embossed paint
Vernissage grainé du bois
Gaufrierte Holzlackierung
Lacado rugoso de la madera

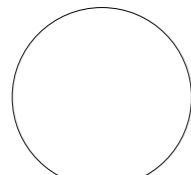

100 Bianco / White / Blanc / Weiß / Blanco rai 9016

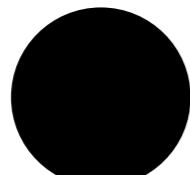

110 Nero / Black / Noir / Schwarz / Negro rai 9005



130 Bordeaux / Burgundy / Bordeaux / Burgunderrot / Burdeos rai 3005

Laccatura lucida legno
Wood glossy lacquer
Laquage brillant du bois
Holzglanzlack
Lacado brillante de la madera

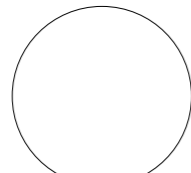

500 Bianco / White / Blanc / Weiß / Blanco rai 9016

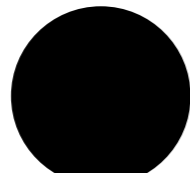

510 Nero / Black / Noir / Schwarz / Negro rai 9005



528 Rosso / Red / Rouge / Rot / Rojo rai 3003

Cemento
Cement
Ciment
Zement
Cimento



Cristallo rivestito in cemento / Plate glass covered with cement / Verre revêtu en ciment / Kristallglas mit Zement verkleidet / Cristal revestido en cemento



Polimex® rivestito in cemento con finitura acrilica / Polimex® covered with acryl finish cement / Polimex® revêtu en ciment avec finition acrylique / Polimex® mit Zement verkleidet und Akryl Finish / Polimex® revestido en cemento, acabado acrilico

Laccatura opaca legno
Wood matt lacquer
Bois laqué mat
Mattierte Holzlackierung
Madera lacada mate

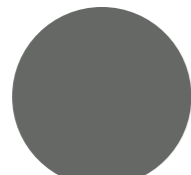

209 Antracite / Anthracite / Anthracite / Anthrazit / Antracita rai 7012

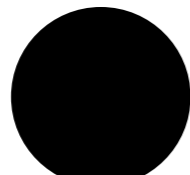

210 Nero / Black / Noir / Schwarz / Negro rai 9005



211 Grigio cenere / Ash-grey / Gris cendre / Aschengrau / Gris ceniza rai 7044

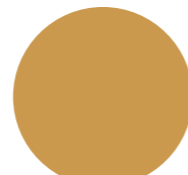

212 Senape / Mustard / Moutarde / Senf / Mostaza

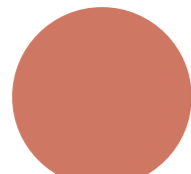

213 Rosa mattone / Rose brick / Rose brique / Rosa-Ziegel / Rosa ladrillo



214 Verde salvia / Sage green / Vert sauge / Salbeigrün / Verde salvia



217 Blu mare / Navy blue / Bleue marine / Marineblau / Azul marino

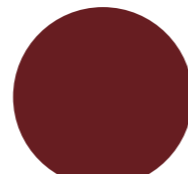

230 Bordeaux / Burgundy / Bordeaux / Burgunderrot / Burdeos rai 3005

Nichelsatinatura
Nickel-satin finish
Nickelage satiné
Vernickeltes Finish
Niquelado satinado



Naturale opaca / Matt natural / Naturel mat / Naturfarben mattiert / Natural mate



Nera opaca / Matt black / Noir mat / Schwarz mattiert / Negro mate

Laminato
Laminate
Laminé
Laminat
Laminado

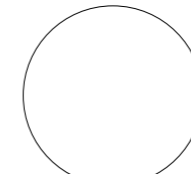

600 Bianco / White / Blanc / Weiß / Blanco

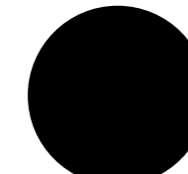

610 Nero / Black / Noir / Schwarz / Negro

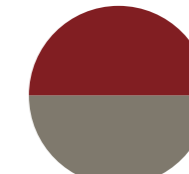

607 Amaranto / Amaranth / Rouge amarante / Amaranrot / Granate

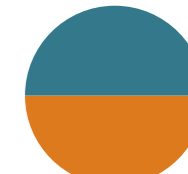

619 Avio / Grey blue / Bleu pétrole / Fliegerblau / Azul verde

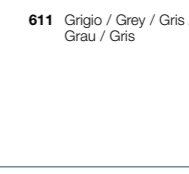

611 Grigio / Grey / Gris / Grau / Gris

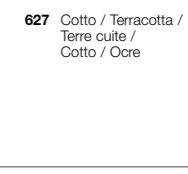

627 Cotto / Terracotta / Terre cuite / Cotto / Ocre

Verniciatura metalli
Metal paint
Peinture métaux
Metall-Lackierung
Pintura metales

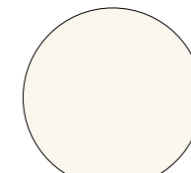

800 Bianco / White / Blanc / Weiß / Blanco rai 9016



801 Azzurro acqua / Light blue / Bleu mer / Hellblau / Azul agua rai 6034



803 Mostarda / Mustard / Moutarde / Senf / Mostaza rai 1012

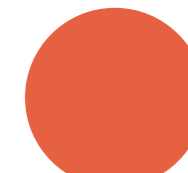

805 Corallo / Coral / Corail / Korallenrot / Coral rai 2012

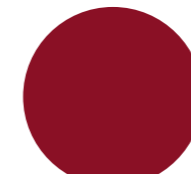

807 Amaranto / Amaranth / Rouge amarante / Amaranrot / Granate rai 3011



808 Verde / Green / Vert / Grün / Verde rai 6004



809 Antracite / Anthracite / Anthracite / Anthrazit / Antracita rai 7012

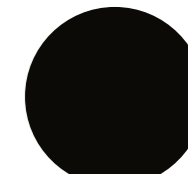

810 Nero / Black / Noir / Schwarz / Negro rai 9005



811 Grigio cenere / Ash grey / Gris cendre / Aschengrau / Gris ceniza rai 7044



812 Grigio ferro / Iron grey / Gris fer / Eisengrau / Gris hierro rai 7016



820 Cromo / Chrome / Chrome / Chromfarben / Cromo

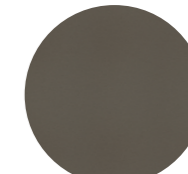

830 Grafite / Graphite / Graphite / Graphit / Grafito

Verniciatura gofrata metalli
Metal embossed paint
Peinture grainée métaux
Gaufrierte Metall-Lackierung
Pintura rugosa metales

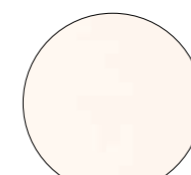

900 Bianco / White / Blanc / Weiß / Blanco rai 9016



907 Amaranto / Amaranth / Rouge amarante / Amaranrot / Granate rai 3011

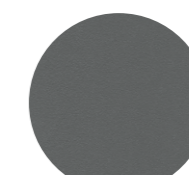

909 Antracite / Anthracite / Anthracite / Anthrazit / Antracita rai 7012



910 Nero / Black / Noir / Schwarz / Negro rai 9005

**Marmo
Marble
Marbre
Marmor
Mármol**



Calacatta grigio / Grey Calacatta /
Gris Calacatta / Grau Calacatta /
Gris Calacatta



Bianco di Carrara / White Carrara /
Blanc Carrara / Weiß Carrara /
Blanco Carrara



Marmo Emperador / Emperador
marble / Marbre Emperador /
Emperador Marmor / Mármol
Emperador

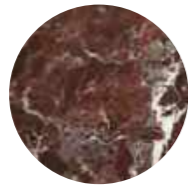

Rosso Lepanto / Red Lepanto /
Rouge Lepanto / Rot Lepanto /
Rojo Lepanto



Marmo Marquinia / Marquinia
marble / Marbre Marquinia /
Marquinia Marmor / Mármol
Marquinia



Marmo Sahara Noir / Sahara Noir
marble / Marbre Sahara Noir /
Sahara Noir Marmor / Mármol
Sahara Noir

**Essenza legno
Wood finish
Essence du bois
Holzart
Esencia de madera**



Acero / Maple / Érable /
Ahornholz / Arce

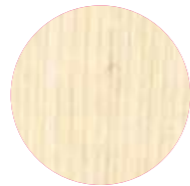

Betulla / Birch / Bouleau / Birke /
Abedul

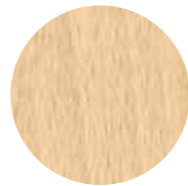

Faggio naturale /
Natural beech / Hêtre naturel /
Naturfarbene Buche /
Haya natural



Faggio evaporato /
Steam-treated beech / Hêtre
éaporé / Gedampfte Buche /
Haya vaporizada



Rovere naturale / Natural
oak / Rouvre naturel /
Naturfarbene Eiche /
Roble natural

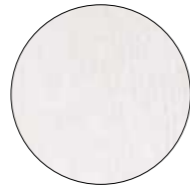

Rovere tinto bianco / White
varnished oak / Rouvre teinté
blanc / Weiss-gebeizte Eiche /
Roble teñido blanco



Rovere tinto noce Canaletto /
Canaletto walnut dyed-oak /
Rouvre teinté Noyer Canaletto /
Nussbaum Canaletto gebeizte
Eiche / Roble teñido nogal
Canaletto

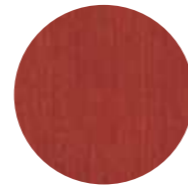

Rovere tinto bordeaux /
Burgundy varnished oak /
Rouvre teinté bordeaux /
Burgunderrot gebeizte Eiche /
Roble teñido burdeos



Rovere tinto grigio / Grey
varnished oak / Rouvre teinté
gris / Grau-gebeizte Eiche /
Roble teñido gris



Rovere tinto nero / Black
varnished oak / Rouvre teinté
noir/Schwarz-gebeizte Eiche /
Roble teñido negro



Noce Canaletto / Canaletto
walnut / Noyer Canaletto /
Nussbaum Canaletto /
Nogal Canaletto

Cristalplant®

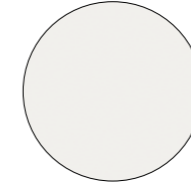

**Cristallo
Plate glass
Verre
Kristallglas
Cristal**

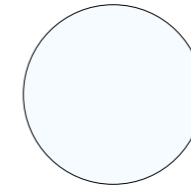

Cristallo trasparente /
Clear plate glass /
Verre transparent / Klares
Kristallglas / Cristal
transparente

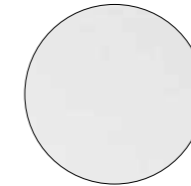

Cristallo extra chiaro trasparente /
Extra-clear plate glass / Verre
extra-clair transparent / Extra klares
Kristallglas / Cristal extraclaro
transparente



Cristallo extra chiaro acidato
verniciato bianco / Extra-clear acidated
white painted plate glass / Verre
extra-clair acidifié verni blanc / Weiß
lackiertes, extra klares und geätztes
Kristallglas / Cristal extraclaro al ácido,
barnizado blanco



Cristallo fumé / Smoky grey
plate glass / Verre fumé gris /
Grau rauchfarbenes
Kristallglas / Cristal gris humo

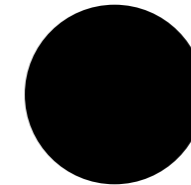

Cristallo verniciato nero /
Black painted plate glass /
Verre verni noir / Schwarz
lackiertes Kristallglas /
Cristal barnizado negro

Tessuti per cuscini
Cushion fabrics
Tissus pour coussins
Stoffe für kleine Kissen
Tejidos por cojines

Quadretto 1



Quadretto 2



Quadretto 3



Quadretto 4



Quadretto 5



Pied de poule 64830



Pied de poule 64851



Pied de poule 64825



Pied de poule 64804



Pied de poule 64856



Pied de poule 64829



Pied de poule 64814



Bright angle **65440**



Bright cube **65315**

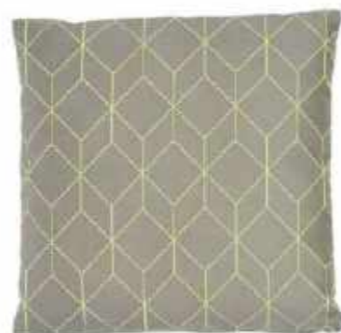

Bright angle **65407**



Bright cube **65325**



Bright angle **65429**



Bright cube **65347**



Django chiaro **65605**



Django chiaro **65652**



Django scuro **65605**



Django scuro **65652**



Django chiaro **65642**



Django chiaro **65657**



Django scuro **65642**



Django scuro **65657**



Ellington 65527



Ellington 65531



Ellington 65542



Ellington 65556



Tulip 65901



Tulip 65902



Tulip 65903



Tulip 65904





Zanotta è membro di Fondazione Altagamma che, dal 1992, riunisce i marchi dell'eccellenza italiana famosi a livello internazionale.

Zanotta is member of the Altagamma Foundation which, since 1992, has gathered together high-end Italian brands famous at international level.



Zanotta è certificata secondo le norme internazionali UNI EN ISO 9001 per i sistemi di gestione per la qualità e UNI ISO 45001 per la sicurezza e salute sui luoghi di lavoro.

Zanotta is certified according to international standards UNI EN ISO 9001 for the quality management systems and UNI ISO 45001 for the safety and health in the workplace.

**Concept, art direction,
photographic style**

RobilantAssociati

Pre-press

Alt@aLuce, Milano

Printing

Grafiche Antiga SpA

Copyright © Zanotta SpA, 2020

All rights reserved

Zanotta S.p.A.

I-20834 Nova Milanese

Via Vittorio Veneto 57

tel 0362 4981

Showroom Zanotta

I-20154 Milano

Caselli di Porta Garibaldi

Piazza XXV Aprile 16

tel 0362 498400

Zanotta USA

1201 Broadway, Ste. 907-909

US - New York, NY, 10001

zanottaspa@zanotta.it

www.zanotta.it

Zanotta spa si riserva di apportare, senza preavviso, modifiche nei materiali, nei rivestimenti, nelle finiture e nei disegni dei prodotti presentati in questo catalogo. Le texture ed i colori dei materiali e delle finiture hanno valore indicativo in quanto soggetti alle tolleranze dei processi di stampa.

Zanotta spa reserves the right to change, without previous notice, materials, covers, finishes and drawings of the products presented in this catalogue. The textures and colours of materials and finishes are indicative as they are depending on the tolerances of the printing process.

Zanotta spa se réserve le droit d'apporter, sans préavis, des modifications au niveau des matériaux, des revêtements, des finitions et du design des produits présentés dans ce catalogue. Les textures et les couleurs des matériaux et des finitions sont une valeurs indicative parce-que ils changent selon la tolérance aux procédés d'imprimerie.

Zanotta spa behält sich vor, ohne Vorankündigung, Veränderungen an den Materialien, Bezügen, Finish und Zeichnungen der in diesem Katalog vorgestellten Produkte vorzunehmen. Die Texturen und Farben der Materialien und Finish haben einen hinweisenden Wert, da sie von den Toleranzen im Druckprozess abhängig sind.

Zanotta spa se reserva el derecho de aportar modificaciones de dibujo, materiales, acabados y tapicerías, sin que esté obligada a dar aviso anticipado. Las texturas y los colores de los materiales y de los acabados tienen solo un valor indicativo porque están sujetos a la tolerancia en los procesos de imprenta.

zanotta:

2022 new products

Re-Connecting

Reconnecting is the theme of the 2022 collection.
Reconnecting with people, with objects
and with Earth in a more sustainable way.

Re-Connecting

It's time to get closer. To people, to things to a different — more conscious — way of living. Let's go back to relating to reality. And let's take advantage of this newfound closeness to bring real people and their authentic needs back to the centre of the design process. In terms of design, the challenge is to be able to translate the new behaviours of living into products capable of responding to multiple needs in an even more satisfying, complete and innovative way. Functional, comfortable and versatile furnishing elements, able to accompany us in all the steps of everyday life. Design objects that last over time without tiring. Made with care in every detail, following the best Italian artisan tradition. Built when possible, with regenerated materials and easy to disassemble, with a view to increasing sustainability. Above all, products with great personality, able to arouse emotions. May they help us, with their silent presence, in the difficult task of reconnecting. With others, with spaces. With the world we live in.

The new 2022 Collection

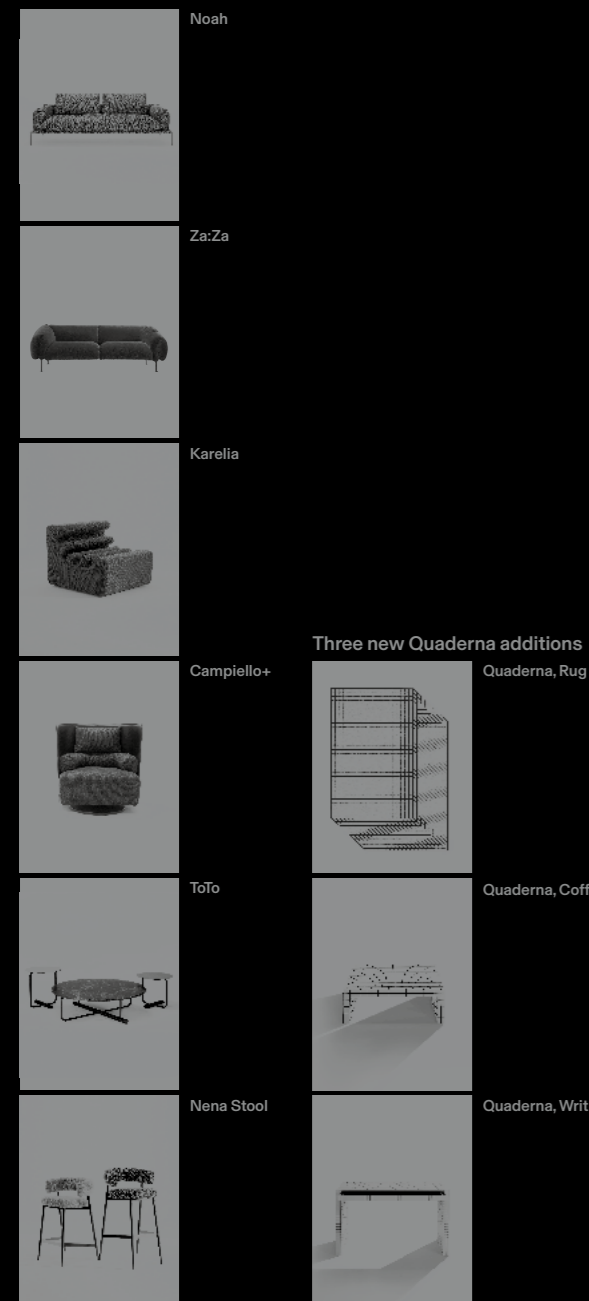

Re-Connecting

È tempo di riavvicinarci. Alle persone, alle cose, a un modo diverso — più consapevole — di vivere. Torniamo a metterci in relazione con il reale. E approfittiamo di questa ritrovata vicinanza per riportare le persone vere e i loro bisogni autentici al centro del processo progettuale. Sul piano del design, la sfida è riuscire a tradurre i nuovi comportamenti dell'abitare in prodotti capaci di rispondere a molteplici esigenze in modo ancora più soddisfacente, completo e innovativo. Elementi d'arredo funzionali, confortevoli e versatili, in grado di accompagnarci in tutti i passaggi della vita quotidiana. Oggetti di design che durino nel tempo senza stancare. Realizzati con cura in ogni dettaglio, nel solco della migliore tradizione artigianale italiana. Costruiti quando possibile con materiali rigenerati e facili da disassemblare, in un'ottica di sempre maggiore sostenibilità. Soprattutto, prodotti ricchi di personalità, che sappiano suscitare emozioni. Che ci aiutino, con la loro silenziosa presenza, nel difficile compito di riconnetterci. Con gli altri, con gli spazi. Con il mondo in cui viviamo.

The new 2022 Collection, La nuova collezione 2022

| | | |
|---------|------------|-------|
| 1345 | Noah | 02-19 |
| 1045 | Za:Za | 20-27 |
| 870 | Karelia | 28-33 |
| 880 | Campiello+ | 34-37 |
| 627,628 | ToTo | 38-41 |
| 2293 | Nena Stool | 42-45 |

Three new Quaderna additions, I tre nuovi pezzi di Quaderna

| | | |
|------|--------------|-------|
| 150 | Rug | 46-47 |
| 656 | Coffee table | 48-49 |
| 2750 | Writing desk | 50-53 |

| | | |
|---|--|-------|
| Technical specifications, Informazioni tecniche | | 54-59 |
|---|--|-------|

Noah

1345



Sketches of a slender rectangular platform upon which all elements are connected became the point of departure for the Noah collection. Designed to adapt to different spaces and needs, Noah Sofa combines small dimensions with extreme modularity. A single seat cushion offers greater flexibility in the use of seating, while the high and enveloping back cushion offers a total comfort. This visually element morphed into an optional curved module. The intention of designer Damian Williamson is to create a relaxed and convivial atmosphere with seating positions that facilitate eye contact. While the integrated wooden trays contribute to the overall graphic expression and provide useful space for our belongings.

Gli schizzi di un'esile piattaforma rettangolare alla quale sono collegati tutti gli elementi sono diventati il punto di partenza per la collezione Noah. Progettato per adattarsi a spazi ed esigenze differenti, il divano Noah unisce ridotte dimensioni a un'estrema modularità. Un cuscino di seduta unico offre una maggiore flessibilità di utilizzo, mentre il cuscino dello schienale alto e avvolgente offre un comfort totale. Questo elemento di leggerezza visiva continua anche in un modulo curvo opzionale. L'intenzione del designer Damian Williamson è quella di creare un'atmosfera rilassante e conviviale con posizioni di seduta che facilitino il contatto visivo. Mentre i vassoi in legno contribuiscono all'espressione grafica complessiva e forniscono spazio utile per i nostri effetti personali.

Designer:

Damian Williamson



↶↑ Noah

Modular sofa, Divano componibile

Fabric, Tessuto: Viburno 28056

Feet, Piedi: Graphite painted steel, Acciaio verniciato grafite



➔ Leather, Pelle: Extra 0479

Details, Dettagli

Noah fits large, medium, small spaces. Maybe we should have called it Zelig.





Noah

Modular sofa, Divano componibile
+ Tray, Vassoio

Fabric, Tessuto: Taiga 32554

Feet, Piedi: Steel feet with glossy black nickel satin finish,
Piedini in acciaio nichelsatinato lucido nero

Detail, Dettaglio



Noah

Fabric, Tessuto: Taiga 32554

Details, Dettagli

“An elegant and formally resolved sofa that creates a welcoming and inclusive space.”







Noah

Modular sofa, Divano componibile
+ Tray, Vassoio

Fabric, Tessuto: Taiga 32503

Feet, Piedi: Steel feet with glossy black nickel satin finish,
Piedini in acciaio nichelsatinato lucido nero

Detail, Dettaglio



↗ Pouf + Tray, Vassoio

Fabric, Tessuto: Taiga 32503

Detail, Dettaglio

↘ Fabric, Tessuto: Taiga 32503

Feet, Piedi: Steel feet with glossy black nickel satin finish,
Piedini in acciaio nichelsatinato lucido nero





Noah Modular sofa, Divano componibile + Tray, Vassoio Fabric, Tessuto: Taiga 32503 Detail, Dettaglio



Noah Modular sofa, Divano componibile + Tray, Vassoio Fabric, Tessuto: Taiga 32503 Feet, Piedi: Steel feet with glossy black nickel satin finish, Piedini in acciaio nichelsatinato lucido nero Detail, Dettaglio





A metal structure, light but solid, acts as a skeleton to this sofa. The straps, not elastic and stretched like traditional sofas, but fixed to the structure, create a suspended seat like a hammock, where you can sink feeling wrapped by a cloud. The cushions, covered sartorially, are soft and abundant. Za:Za is the result, as the name suggests, of a close collaboration between Zaven and Zanotta, a work of synthesis and deconstruction, where the canonical elements that make up the sofa have been examined, decomposed and reduced to the essentials. In Za:Za the sustainability aspect is primary: no glues are used and all materials are easily recyclable.

Una struttura in metallo, leggera ma solida, fa da scheletro a questo divano. Le cinghie, non elastiche e tese come nei divani tradizionali ma fissate alla struttura, creano una seduta sospesa come un'amaca, dove sprofondare sentendosi avvolti da una nuvola. I cuscini, rivestiti sartorialmente, sono morbidi e abbondanti. Za:Za è il risultato, come suggerisce il nome, di una stretta collaborazione tra Zaven e Zanotta, un lavoro di sintesi e decostruzione dove gli elementi canonici che compongono il divano sono stati esaminati, scomposti e ridotti all'essenziale. In Za:Za l'aspetto della sostenibilità è primario: non vengono utilizzate colle e tutti i materiali sono facilmente riciclabili.

Designer:

Zaven



Za:Za

Monobloc sofa, Divano monoblocco

Fabric, Tessuto: Quid 40357

Steel frame, Struttura: Matt red varnished, Acciaio verniciato rosso opaco

Soft as a cloud, cozy as a hammock.



Za:Za

Monobloc sofa, Divano monoblocco

Fabric, Tessuto: Quid 40357

Steel frame, Struttura: Matt red varnished,
Acciaio verniciato rosso opaco



↓↑ Fabric, Tessuto: Quid 40357

Details, Dettagli





“We have explored a language that offers a comfortable and environmentally conscious product.”



Za:Za Monobloc sofa, Divano monoblocco Fabric, Tessuto: Top 31905 Steel frame, Struttura: Matt black varnished, Acciaio verniciato nero opaco

↑↓ Za:Za Monobloc sofa, Divano monoblocco Steel frame details, Dettagli struttura in acciaio



“Abbiamo esplorato un linguaggio formale e tecnico che considera non solo l'estetica e il comfort, ma anche la razionalizzazione dei cicli di produzione e riciclo, per offrire un prodotto confortevole e ecosostenibile.”



Designed by the Finnish Liisi Beckmann, this 60's pop icon owes its name to the Karelia, the region where the designer was born and that has always remained in her heart. And that still intact land, indented by creeks, gulfs, lakes, inspires that feeling of joy and freedom that here becomes an intact wavy sign of the seat. The armchair embodies in itself the free and experimenting language of the Sixties and Seventies, a sculptural furniture that absolutely does not show its fifty years. This timeless cult object is now proposed by Zanotta after a careful tuning of the coating and comfort. The double density of polyurethane, the slight enlargement of the seat and the padding in bielastic foam with very high resistance, guarantee greater comfort and the maintenance of the shape over time.

Disegnata dalla finlandese Liisi Beckmann, questa icona pop degli anni '60 deve il suo nome alla Karelia, la regione dove è nata la designer e che le è sempre rimasta nel cuore. E quella terra ancora intatta, frastagliata da insenature, golfi, laghi, ispira quella sensazione di gioia e libertà che qui diventa un caratteristico segno ondulato della seduta. La poltrona incarna in sé il linguaggio libero e sperimentale degli anni Sessanta e Settanta, un arredo scultoreo che non mostra assolutamente i suoi cinquant'anni. Questo oggetto cult senza tempo viene ora riproposto da Zanotta dopo un'attenta messa a punto del rivestimento e del comfort. La doppia densità del poliuretano, il leggero ampliamento della seduta e l'imbottitura in schiuma bielastica ad altissima resistenza garantiscono un maggiore comfort e il mantenimento della forma nel tempo.

Designer:

Liisi Beckmann, 1966



Karelia

Armchair, Poltrona

↑ Fabric, Tessuto: Samba 32747
↖ Fabric, Tessuto: Samba 32756

74 × 80 × 60 cm
h. seat, seduta 35 cm

Detail, Dettaglio

“Karelia is the region where I was born. An uncontaminated land, rich of gulf and lakes, that has always remained in my heart.”



A Karelia Armchair, Poltrona Fabric, Tessuto: A, Samba 32726 B, Samba 32747 C, Samba 32703 D, Samba 32757

Karelia Armchair, Poltrona Fabric, Tessuto: Samba 32756



Karelia Armchair, Poltrona Fabric, Tessuto: Samba 32756 (Top) Fabric, Tessuto: Samba 32726 (Bottom)



People are often so boring.
At least design shouldn't be.



Karelia

Armchair, Poltrona

Fabric, Tessuto: Samba 32703



Karelia

Armchair, Poltrona

↖ Fabric, Tessuto: Samba 32756
↑ Fabric, Tessuto: Samba 32726
↗ Fabric, Tessuto: Samba 32758



Karelia

Armchair, Poltrona

Fabric, Tessuto: Samba 32757

In the end, everything revolves around design.



Designed in 1984 by De Pas, D'Urbino, Lomazzi, Campiello is back today as Campiello+. Still very innovative in shape, it is made even more current thanks to the wider seat, the insertion of the swivel base and the enlarged shaped cowhide shell to comfortably accommodate the shoulders. In the Campiello+ armchair, the high backrest upholstered in cowhide embraces the padded seat, completed by a lumbar cushion and an additional headrest. The swivel conic base rotates 360°. A protective alcove whose bent shell embraces and separates, also visually, the person from the environment, providing comfort and privacy at the same time.

Disegnata nel 1984 da De Pas, D'Urbino, Lomazzi, la poltrona Campiello torna oggi con il nome Campiello+. Il design, ancor oggi molto innovativo, è reso ancora più attuale grazie alla seduta più ampia, all'inserimento della base girevole e alla scocca in cuoio sagomata per accogliere comodamente le spalle. Nella poltrona Campiello+, lo schienale alto rivestito in cuoio abbraccia la seduta imbottita, completata da un cuscino lombare e da un poggiatesta aggiuntivo. La base conica girevole ruota di 360°. Un'alcova protettiva il cui guscio ricurvo abbraccia e separa, anche visivamente, la persona dall'ambiente circostante, offrendo comfort e privacy allo stesso tempo.

Designer:

De Pas, D'Urbino, Lomazzi, 1984



Campiello+ Swivel armchair, Poltrona girevole

↖ External sling in cowhide 0714, seat and lumbar cushion in fabric Top 31903, Scocca esterna in cuoio 0714, sedile e cuscino poggiatesta in tessuto Top 31903

↑ External sling in cowhide 0714, seat and lumbar cushion in fabric Top 31904, scocca esterna in cuoio 0714, sedile e cuscino poggiatesta in tessuto Top 31904

83 × 70 × 87 cm
h. seat, h. seduta 41 cm



Campiello+ Swivel armchair, Poltrona girevole

↑ External sling in cowhide 0714, seat and lumbar cushion in fabric Top 31903, Scocca esterna in cuoio 0714, sedile e cuscino poggiatesta in tessuto Top 31903

↗ External sling in cowhide pigmentato 0801, seat in fabric Victor 28120, lumbar cushion in fabric Victor 28121, Scocca esterna in cuoio pigmentato 0801, sedile in tessuto Victor 28120, cuscino poggiatesta in tessuto Victor 28121



Details, Dettagli

↗ Campiello+

External sling in cowhide 0714, seat and lumbar cushion in fabric Top 31903, Scocca esterna in cuoio 0714, sedile e cuscino poggiatesta in tessuto Top 31903



“Campiello+ is ready to welcome people of all backgrounds and in all environments, but beware that your pet will make it its home!”

“Campiello+ è pronta ad accogliere con affetto, alti e bassi, magri e grassi, belli e brutti, laici e uomini di fede di diverse razze, ma attenzione a Snoopy che ne farà il suo spazio preferito”.

Elegant from head to toe.



A playful geometry and a graphic elegance define the spirit of the ToTo collection. Designed by Bertrand Lejoly as a homage to the Italian 1980s, this versatile tables collection is a nod to the joyful aesthetic of Memphis, with a modern sensitivity. The unique central base is a characteristic element of the ToTo coffee table. Its slender steel structure and lacquered wooden foot support the top, coming in different high-end finishes. The three different heights and the array of marbles and cowhide offers many possibilities to freely combine them. These beautiful materials, delicately assembled in a simple yet sophisticated equilibrium, make ToTo an outstanding domestic piece of jewellery.

Una geometria giocosa e un'eleganza grafica definiscono lo spirito della collezione ToTo. Progettato da Bertrand Lejoly come omaggio agli anni '80 italiani, questa versatile collezione di tavolini è un rimando all'estetica gioiosa di Memphis, ma con una sensibilità moderna. La base centrale unica è un elemento caratteristico del tavolino ToTo. La sua snella struttura in acciaio e il piede in legno laccato sostengono il piano, disponibile in diverse finiture di alta gamma. Le tre diverse altezze e la gamma di marmi e cuoio offrono infinite possibilità di combinarli liberamente. Questi preziosi materiali, composti con delicatezza in un equilibrio semplice ma sofisticato, fanno di ToTo uno splendido gioiello domestico.

Designer:

Bertrand Lejoly



↑ ToTo

Coffee table, Tavolino

Top, Piano: Green Alpi marble, Marmo verde Alpi
Steel frame, Struttura: Matt black varnished, Acciaio verniciato nero opaco
Foot, Piede: Glossy green beech, Faggio verde lucido

Ø 110 x 32 cm

Detail, Dettaglio



ToTo

Coffee table, Tavolino

↻ Ø 45 × 50 cm

↑ Ø 110 × 32 cm

↑ Ø 45 × 42 cm



ToTo

Top, Piano: Green Alpi marble, Marmo verde Alpi
Steel frame, Struttura: Matt black varnished, Acciaio verniciato nero opaco
Foot, Piede: Glossy green beech, Faggio verde lucido

Ø 110 × 32 cm

Top, Piano: White Carrara marble, Marmo bianco di Carrara
Steel frame, Struttura: Matt black varnished, Acciaio verniciato nero opaco
Foot, Piede: Glossy black beech, Faggio nero lucido

Ø 45 × 50 cm

←← p. 38
ToTo

(From left, Da sinistra)

Top, Piano: White Carrara marble, Marmo bianco di Carrara
Steel frame, Struttura: Matt black varnished, Acciaio verniciato nero opaco
Foot, Piede: Glossy black beech, Faggio nero lucido

Ø 45 × 50 cm

Top, Piano: Cowhide pigmentato 0841, Cuoio pigmentato 0841
Steel frame, Struttura: Matt black varnished, Acciaio verniciato nero opaco
Foot, Piede: Glossy black beech, Faggio nero lucido

Ø 45 × 42 cm

Top, Piano: Cowhide pigmentato 0841, Cuoio pigmentato 0841
Steel frame, Struttura: Matt black varnished, Acciaio verniciato nero opaco
Foot, Piede: Glossy black beech, Faggio nero lucido

Ø 45 × 50 cm

Top, Piano: Green Alpi marble, Marmo verde Alpi
Steel frame, Struttura: Matt black varnished, Acciaio verniciato nero opaco
Foot, Piede: Glossy green beech, Faggio verde lucido

Ø 45 × 42 cm

40

cod. 627, 628

“ToTo is the idea of joyfulness and elegance brought together in one piece of furniture.”

“ToTo per me è l'idea di allegria ed eleganza riunite in un unico mobile.”

Nena Stool

2293



“We started from the comfort of the hug to design the Nena chair. We applied the same concept in the stool with its recognizable dynamic form.”

The Nena collection, designed by Lanzavecchia+Wai, is enriched with this new high stool, able to combine a distinctive design and a comfort difficult to match in this particular type of seating. The generous padding of the seat and backrest ensures a comfortable position even when sitting for a long time. The back, wide as an embrace, is characterized by a strip of fabric that hides the zip, to make the stool completely removable. The momentum of the inclined legs gives lightness and dynamism to the whole structure, in fact solid and durable. Two available heights make Nena Stool ideal for both public and domestic spaces.

La collezione Nena, disegnata da Lanzavecchia+Wai, si arricchisce con questo nuovo sgabello alto, in grado di coniugare un design distintivo e una comodità difficilmente eguagliabile in questa particolare tipologia di seduta. La generosa imbottitura del sedile e dello schienale assicura una posizione comoda anche stando seduti a lungo. Lo schienale, largo come un abbraccio, è caratterizzato da una fascia di tessuto che nasconde la cerniera, per rendere lo sgabello completamente sfoderabile. Lo slancio delle gambe inclinate dona leggerezza e dinamismo a tutta la struttura, che è solida e resistente. Due altezze disponibili rendono il Nena Stool ideale sia per spazi pubblici che domestici.

Designer:

Lanzavecchia+Wai



Nena Stool

Stool, Sgabello

↖ Fabric, Tessuto: Victor 28115
↗ Fabric, Tessuto: Victor 28116

Steel frame, Struttura:
Matt black varnished, Acciaio verniciato nero

↖ 56 × 52 × 77 cm
h. seat, h. seduta 67 cm
↗ 56 × 52 × 98 cm
h. seat, h. seduta 88 cm

“Siamo partiti dalla comodità di un abbraccio per progettare la sedia Nena. Quest’anno abbiamo applicato lo stesso concetto allo sgabello, adatto a caratterizzare lo spazio con la sua estetica riconoscibile, dinamica e raffinata in ogni dettaglio.”

High up on comfort!



Nena Stool Fabric, Tessuto: Victor 28115 Steel frame, Struttura: Matt black varnished, Acciaio verniciato nero Detail, Dettaglio



Nena Stool Fabric, Tessuto: Victor 28116 Steel frame, Struttura: Matt black varnished, Acciaio verniciato nero Detail, Dettaglio



Nena Stool Stool, Sgabello Fabric, Tessuto: Victor 28115 Fabric, Tessuto: Victor 28116 Steel frame, Struttura: Matt black varnished, Acciaio verniciato nero

Quaderna Rug

150

Quaderna turns fifty
and it's always revolutionary.

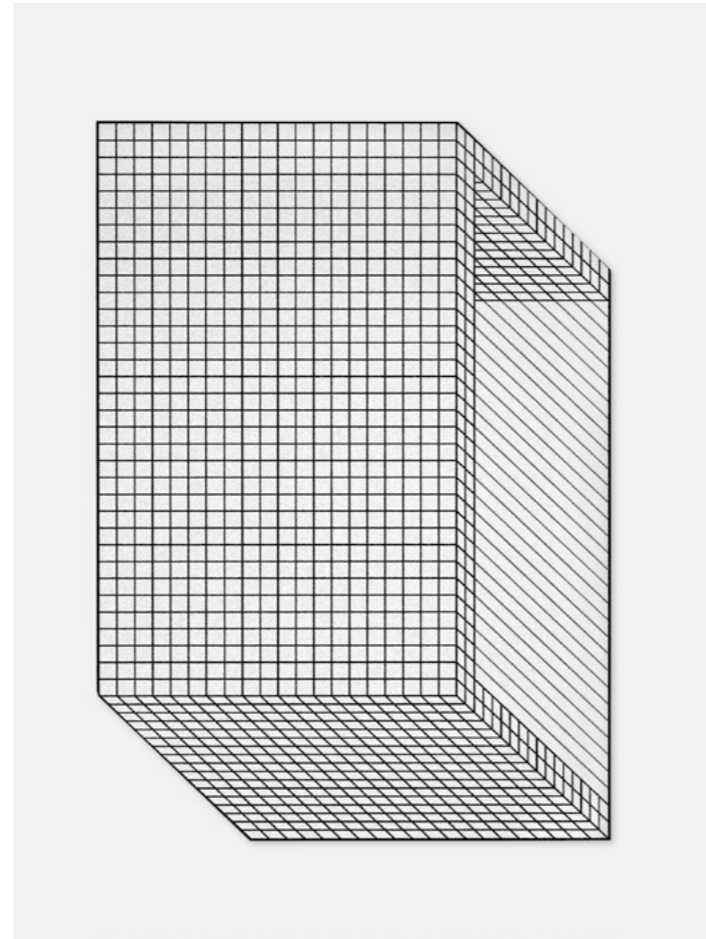

The rug was made by selecting an unprecedented architecture Istogramma from the archives of Cristiano Toraldo di Francia. It is hand-tufted with uniform fleece across the entire surface and made from 100% New Zealand wool with an underside backing in 100% cotton canvas. The perimeter edging is hand-made with wool thread. It is available in two sizes solely with a white background and grey and black lines, respecting the original design.

Il tappeto è stato realizzato selezionando dall'archivio di Cristiano Toraldo di Francia un istogramma di architettura inedito. È tuftato a mano con vello uniforme su tutta la superficie e realizzato in 100% lana neozelandese con un supporto inferiore in 100% tela di cotone. La bordatura perimetrale è eseguita a mano con filo di lana. È disponibile in due dimensioni esclusivamente con fondo bianco e linee grigie e nere, nel rispetto del disegno originale.

Designer:

Superstudio
/ Cristiano Toraldo di Francia
1972-2022

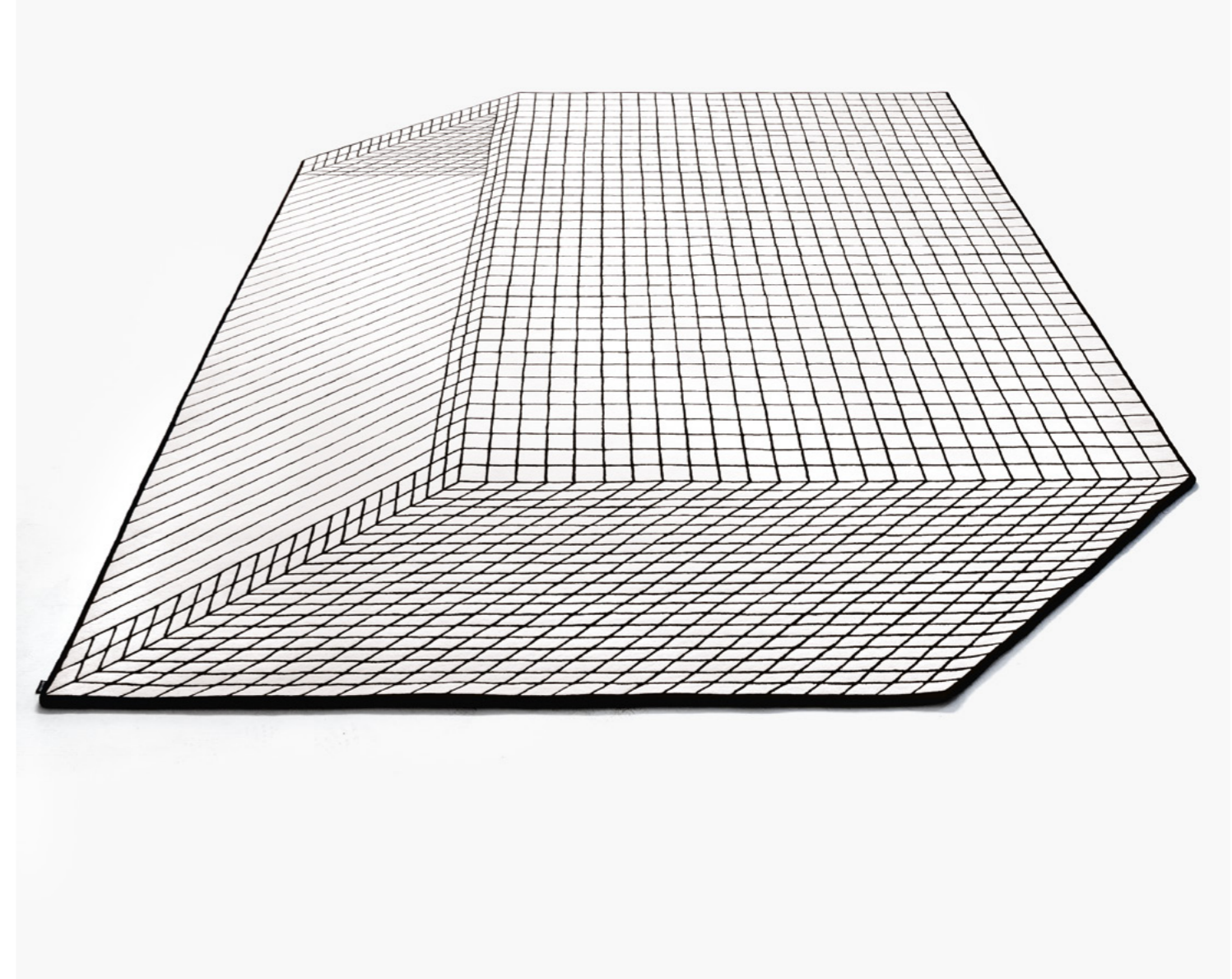

Quaderna

Rug

250 x 350 cm

From an original drawing of, Da un disegno originale di Cristiano Toraldo di Francia

Quaderna Coffee table

656

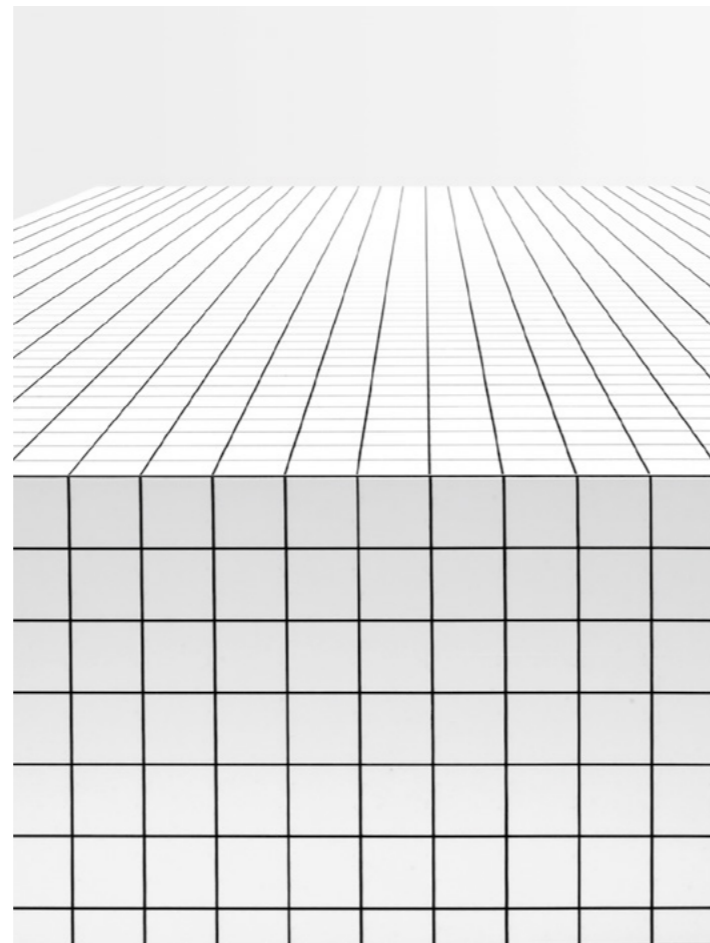

The square-shaped coffee table is perfect for use in a living room. The game of orthogonal lines is enhanced by the square tabletop and the alternating blocks and voids of the base. It is 30 cm high and can also be matched with a small table or a console from the same series to create an unprecedented effect of staggered surfaces.

Il tavolino basso di forma quadrata è perfetto come complemento per un salotto. Il gioco delle linee ortogonali è esaltato dal piano quadrato e dall'alternanza di pieno e vuoto della base. È alto 30 cm, e può essere anche abbinato a un tavolino o a una consolle della stessa serie per creare un inedito effetto di piani sfalsati.

Designer:

Superstudio, 1972–2022

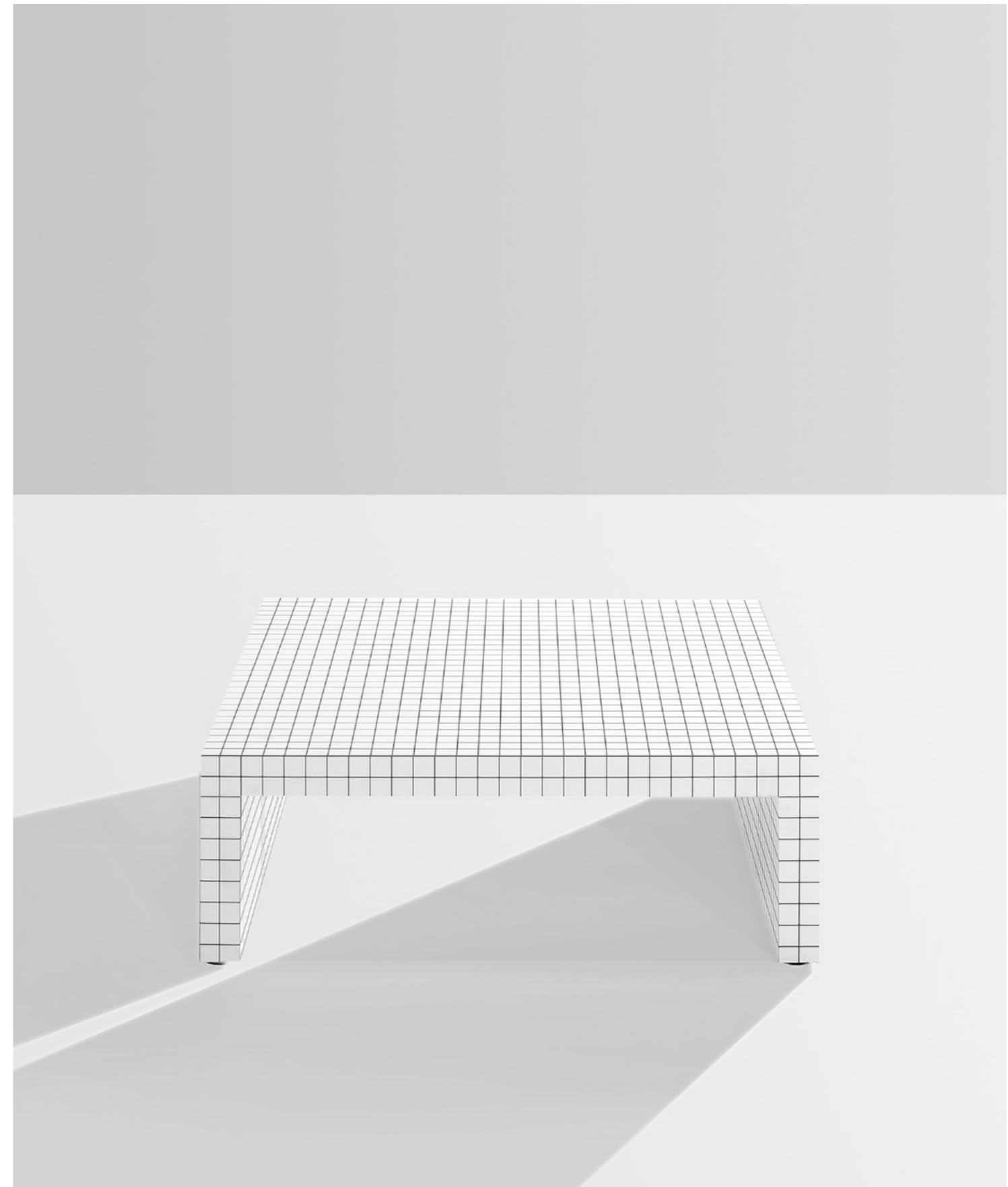

Quaderna

Coffee table, Tavolino

90 × 90 × 30 cm

Quaderna Writing desk

2750

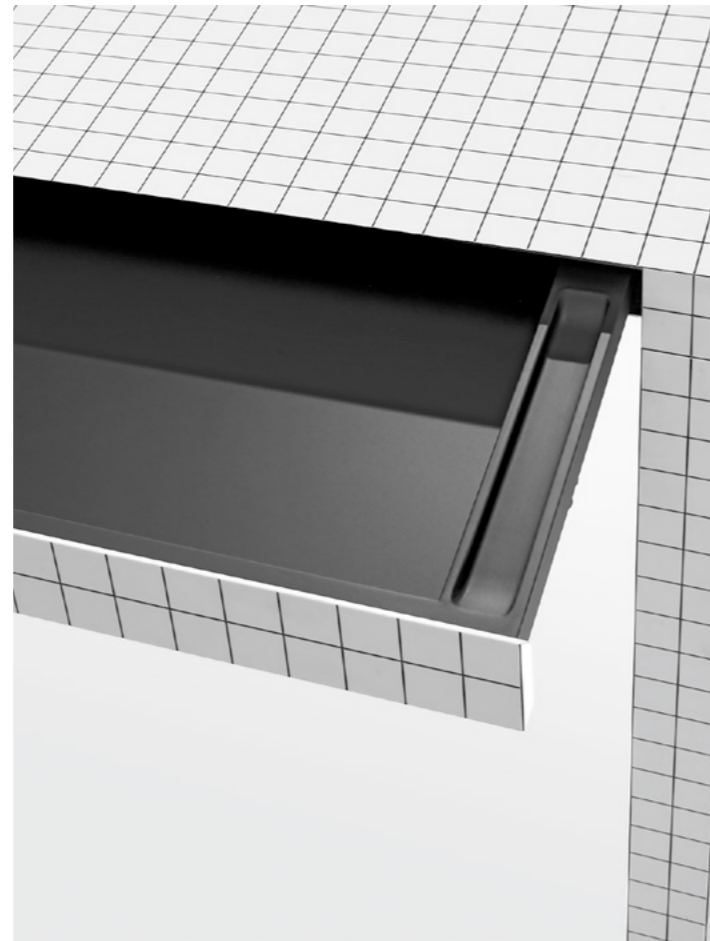

The desk, which is compact and functional in size, conceals a practical retractable drawer that occupies the full width of the desktop. Ideal as a home workstation, it fits in seamlessly in any room of the home.

Lo scrittoio, dalle proporzioni compatte e funzionali, nasconde un pratico cassetto a scomparsa che occupa tutta la larghezza del piano. Ideale come postazione di lavoro domestica, si inserisce con facilità in qualunque ambiente della casa.

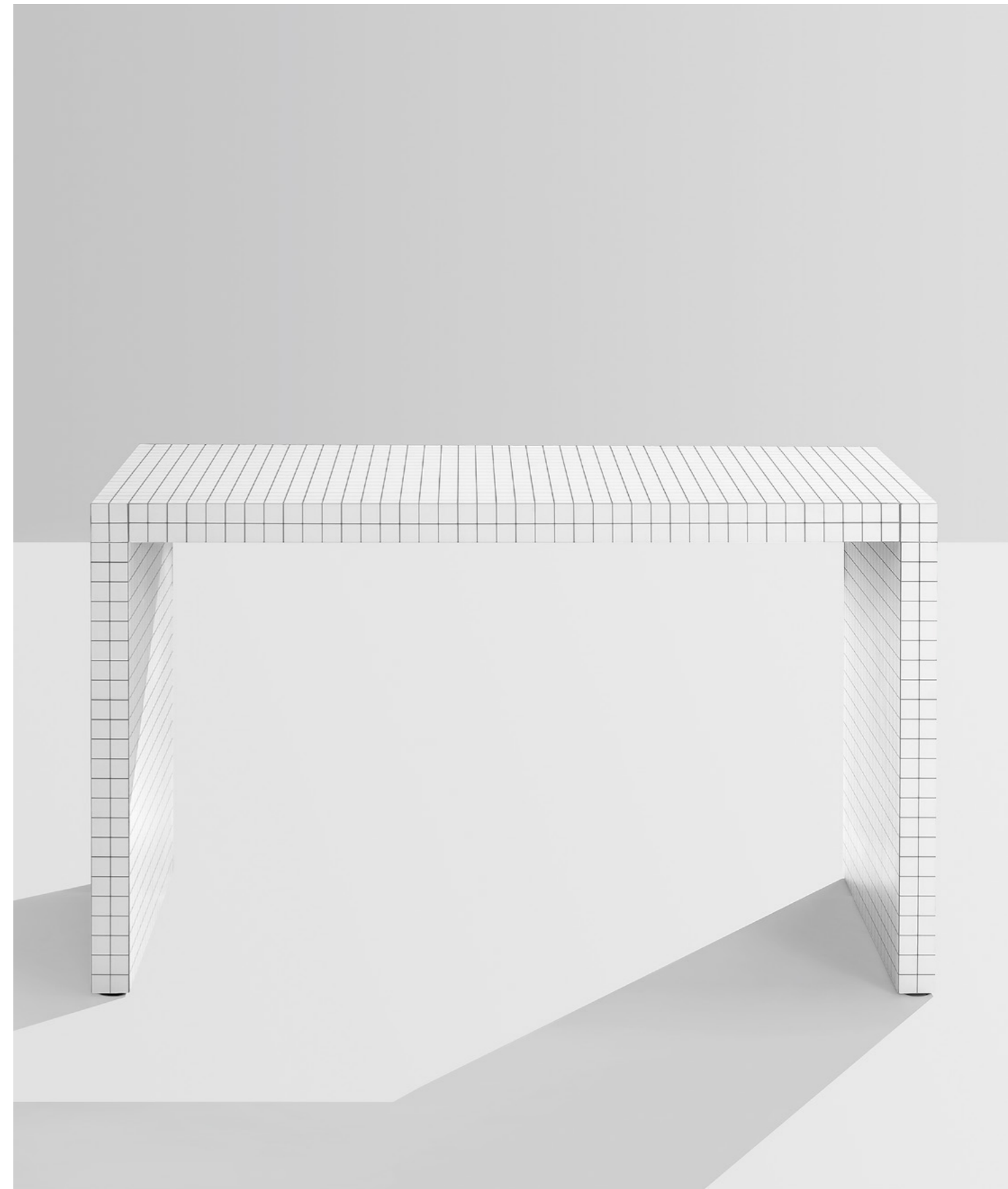

Quaderna

Writing desk, Scrittoio

With retractable drawer,
Con cassetto a scomparsa

132 × 54 × 75 cm

Designer:

Superstudio, 1969–1972



Quaderna Writing desk, Scrivitoio 132 x 54 x 75 cm Retractable drawer, Cassetto a scomparsa



71 Writing desk, Scrivitoio Retractable drawer, Cassetto a scomparsa Details, Dettagli

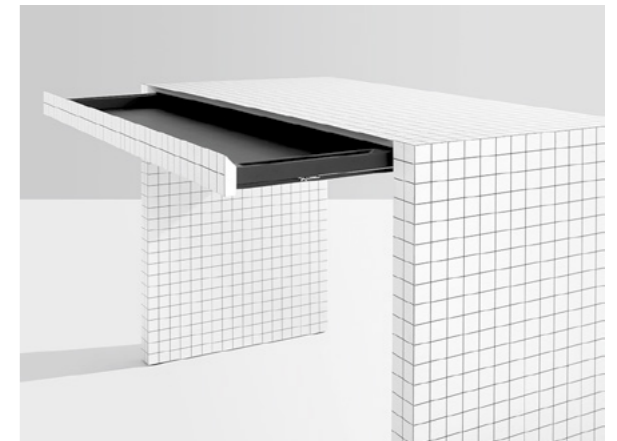

Monobloc, straight and curved modular sofas with armrest or tray, pouf

Steel feet, with glossy black nickel-satin finish or varnished graphite. Steel frame. Elastic strips suspension. Single-piece seat cushion in polyurethane/regenerated and regenerable polyester flakes. Back cushion in 100% new goose feathers. Armrest cushion in regenerated and regenerable polyester flakes. The straight and curved end-sofas can be equipped with an armrest cushion or with a tray, made of solid matt black painted ash with open pore, placed on the supporting base of the sofa. Removable fabric or leather cover.

One round-shaped tray, diameter 45 cm, made of solid matt black painted ash with open pore, is available and can be placed as desired on the seat cushions. The side panels are covered in the same fabric or leather as the cushions.

Divani monoblocco, componibili rettilinei e curvi con bracciolo o vassoio, pouf

Piedini in acciaio nichelsatinato lucido colore nero oppure verniciato colore grafite. Struttura in acciaio. Molleggio su nastri elastici. Cuscino seduta unico in poliuretano/fiocchi di poliestere rigenerato e rigenerabile. Cuscino schienale in piuma d'oca — materiale 100% vergine. Cuscino bracciolo in fiocchi di poliestere rigenerato e rigenerabile. Gli elementi terminali rettilinei e curvi possono essere dotati di cuscino bracciolo oppure essere attrezzati con un vassoio in legno massello di frassino verniciato nero poro aperto opaco sulla base portante del divano. Rivestimento sfilabile in stoffa o in pelle.

È disponibile un vassoio circolare Ø 45 cm in legno massello di frassino verniciato nero poro aperto opaco che può essere appoggiato liberamente sui cuscini di seduta. I pannelli perimetrali sono rivestiti nella stessa stoffa o pelle dei cuscini.

1345 Noah

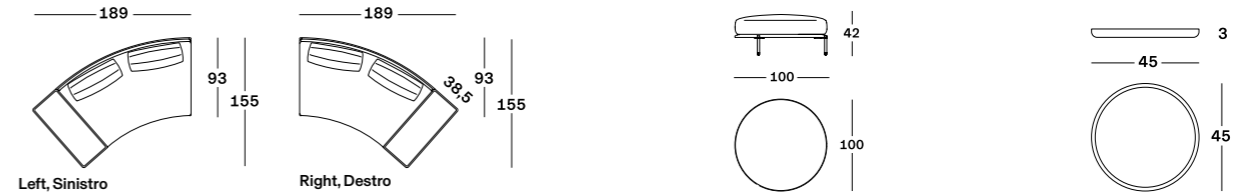

Rounded sofa with tray 189
Divano curvo con vassoio 189

Pouf

Rounded tray
Vassoio tondo

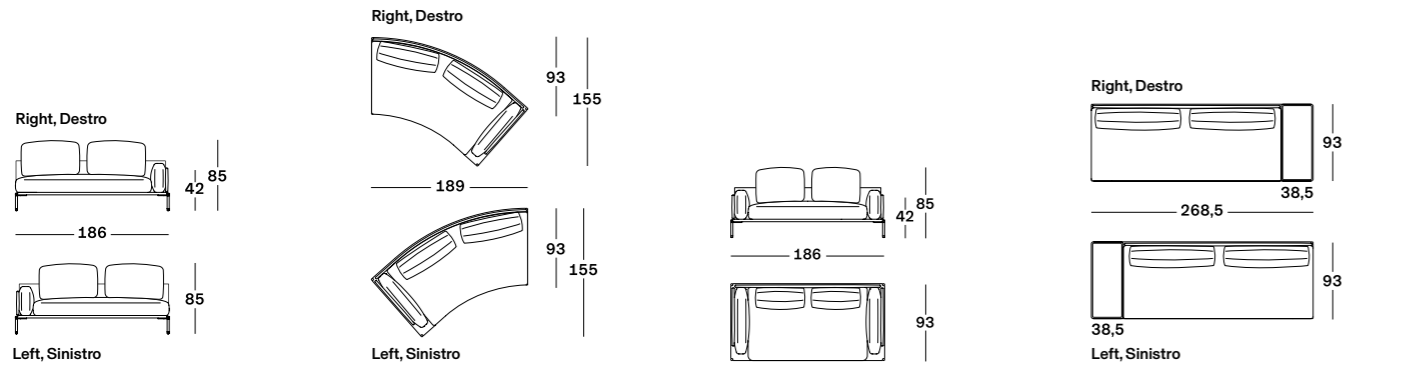

Endsofa 186
Terminale 186

Rounded endsofa 189
Terminale curvo 189

Sofa 186
Divano 186

Sofa with tray 268,5
Divano con vassoio 268,5

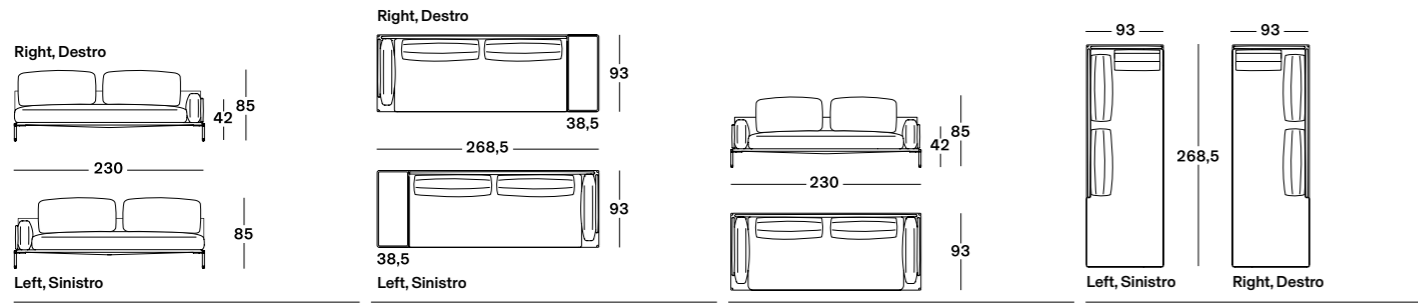

Endsofa 230
Terminale 230

Rounded sofa with tray 268,5
Terminale con vassoio 268,5

Sofa 230
Divano 230

Sofa 268,5
Divano 268,5

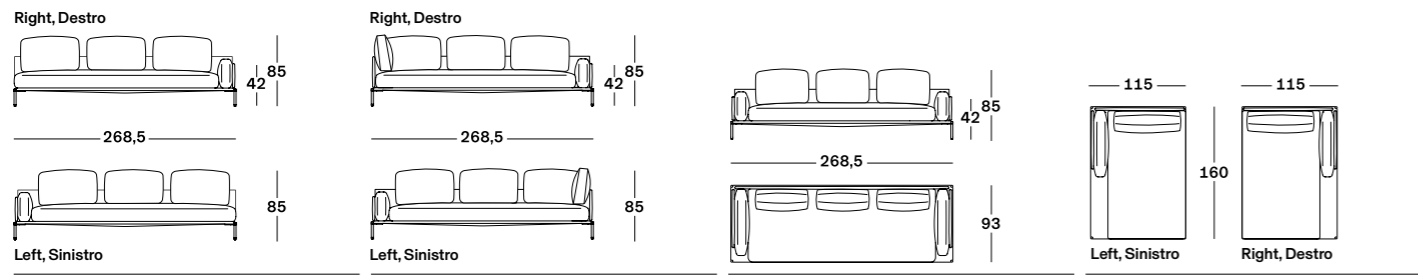

Endsofa 268,5
Terminale 268,5

Angular endsofa 268,5
Terminale angolare 268,5

Sofa 268,5
Divano 268,5

Lounge chair 115
Poltrona allungata 115

1345 Noah

Examples of compositions

Esempi di composizione

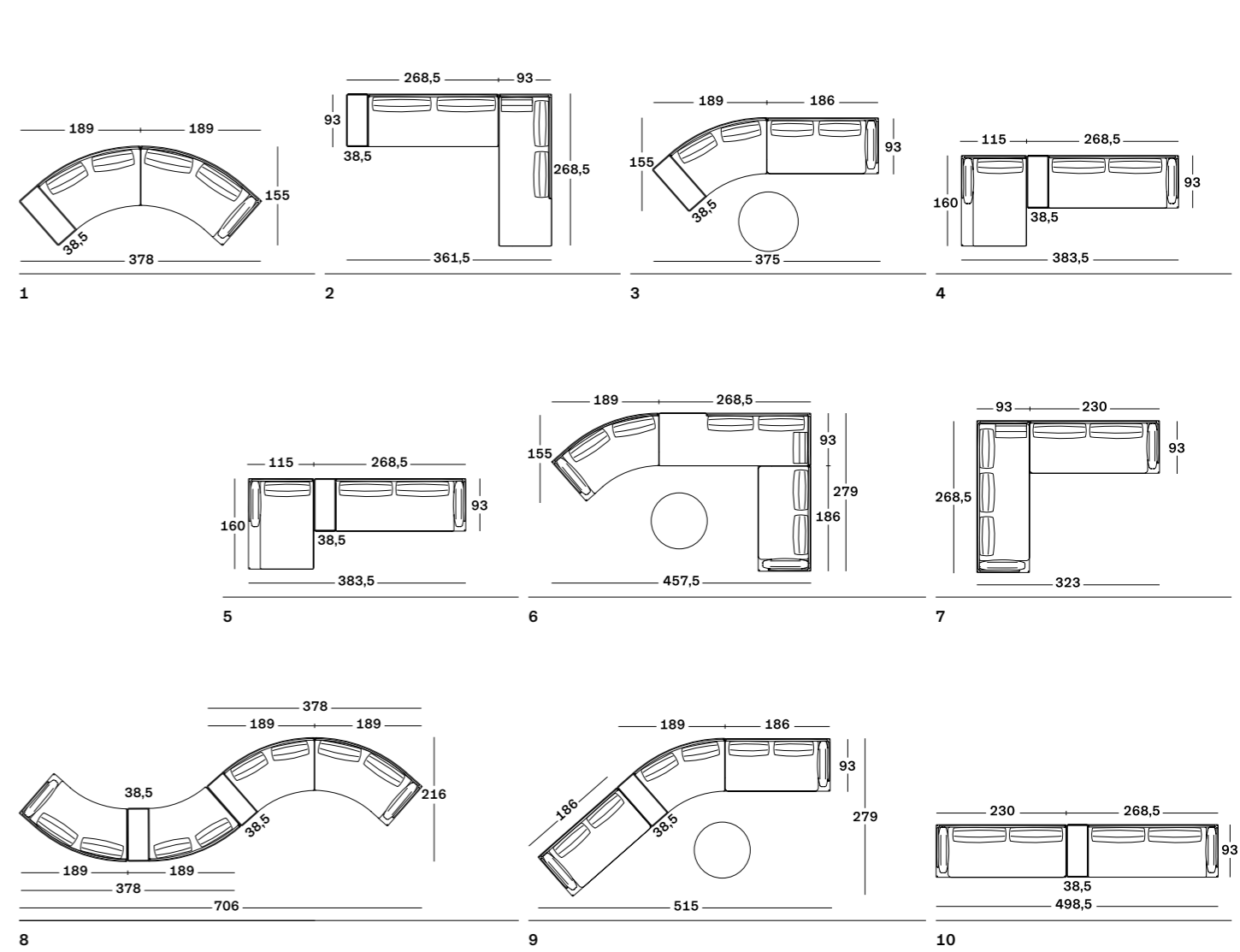

1045 Za:Za
Zaven
2022

Monobloc sofas

Carrying frame in matt black or red RAL 3004 steel, complete of stiff polyester straps in the shade anthracite for the support of the cushions. Seat, back and armrest cushions in polyurethane/ regenerated and regenerable polyester balls. Paddings assembly without glues. Removable fabric cover.

Divani monoblocco

Struttura portante in acciaio verniciato colore nero o rosso opaco RAL 3004 dotata di nastri rigidi in poliestere colore antracite per il supporto dei cuscini. Cuscini seduta, schienale e bracciolo in poliuretano/ sfere di poliestere rigenerato e rigenerabile. Assemblaggio imbottiture privo di collanti. Rivestimento sfilabile in stoffa.

880 Campiello+
De Pas, D'Urbino, Lomazzi
1984-2022

Swivel armchair

Backrest in plywood covered with cowhide pigmentato 90 in the shades black, anthracite and mud or with cowhide 95 in the shade gold. Seat in graduated polyurethane/regenerated and regenerable polyester flakes; lumbar and back cushion in regenerated and regenerable polyester flakes. Removable fabric cover. Only the lumbar cushion can be requested in a distinct colour within the same fabric.

Poltrona girevole

Schienale in multistrato di legno ricoperto in cuoio pigmentato 90 nei colori nero, antracite e fango o cuoio 95 nel colore gold. Sedile in poliuretano a quote differenziate/fiocchi di poliestere rigenerato e rigenerabile; poggiatesta e cuscino schienale in fiocchi di poliestere rigenerato e rigenerabile. Rivestimento sfilabile in stoffa. Solo il cuscino poggiatesta può essere richiesto in un colore diverso all'interno della stessa tipologia di tessuto.

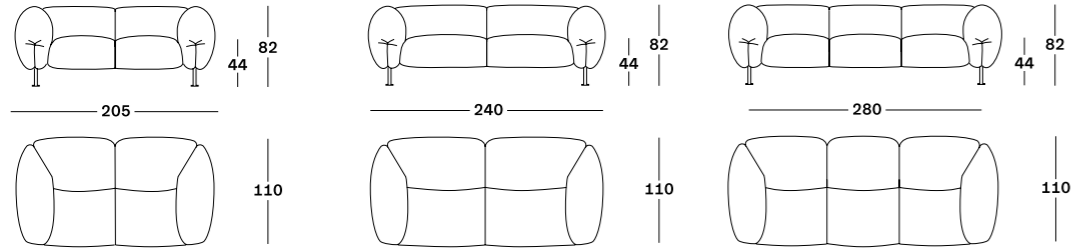

Sofa 205
Divano 205

Sofa 240
Divano 240

Sofa 280
Divano 280

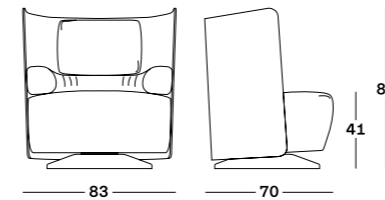

870 Karelia
Liisi Beckmann
1966

Armchair

Graduated polyurethane foam frame. External cover only available in bielastic Samba fabric.

Poltrona

Struttura in poliuretano espanso a quote differenziate. Rivestimento esterno sfilabile realizzabile solo nel tessuto bielastico Samba.

627/628 ToTo
Bertrand Lejoly
2022

Coffee tables

Matt black varnished steel frame. Steel sheet tops, covered with cowhide pigmentato 90 in the shades gold, black, anthracite and mud matching the foot in glossy black painted beech; or tops made of white Carrara or green Alpi marbles, matching the foot respectively in glossy white RAL 9010 painted or glossy green RAL 6012 painted beech.

Tavolini

Struttura in acciaio verniciato colore nero opaco. Piani in lamiera di acciaio rivestiti in cuoio pigmentato 90 nei colori gold, nero, antracite e fango in abbinamento al piede in faggio laccato colore nero lucido, oppure piani in marmo bianco di Carrara o verde Alpi, in abbinamento rispettivamente al piede in faggio laccato colore bianco lucido RAL 9010 o verde lucido RAL 6012.

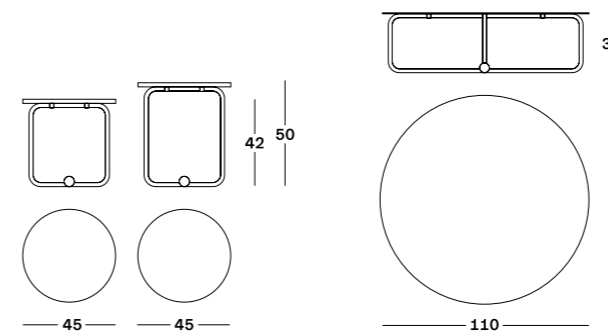
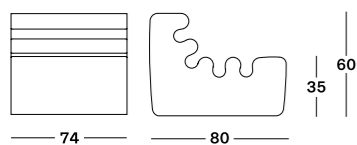

627

628

2293 Nena Stool
Lanzavecchia+Wai
2022

Stool

Steel frame varnished graphite or matt black. Seat upholstered with polyurethane; backrest upholstered with self-extinguishing polyurethane foam. Removable fabric or leather cover. Footrest covered with satin-finished stainless steel.

Sgabello

Struttura in acciaio verniciato colore grafite o nero opaco. Imbottitura sedile in poliuretano, imbottitura schienale in poliuretano schiumato autoestinguente. Rivestimento sfilabile in stoffa o in pelle. Poggiatesta ricoperto in acciaio inox satinato.

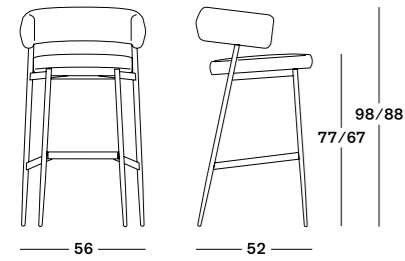

656 Quaderna, Coffee table
Superstudio
1972-2022

Coffee table

Honeycomb core structure coated with white Print laminate, digitally printed with black squares at 3 cm spacing.

Tavolino

Struttura in legno tamburato placcato laminato Print, colore bianco, a stampa digitale a quadretti con interasse di 3 cm.

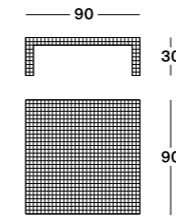

150 Quaderna, Rug
Superstudio / Cristiano Toraldo di Francia
1972-2022

Rug

Hand-tufted rug with uniform fleece over the entire surface made of 100% New Zealand wool. Perimeter edging finished by hand with wool thread on all six sides. Available in sizes 200 x 300 cm and 250 x 350 cm in a single colour scheme: white background and grey and black lines compliant with the original design.

Tappeto

Tappeto tuftato a mano con vello uniforme su tutta la superficie realizzato in 100% lana neozelandese. Bordatura perimetrale eseguita a mano con filo di lana a rifinire i sei lati. Disponibile nella dimensione 200 x 300 e 250 x 350 cm in un unico colore: fondo bianco e linee grigie e nere in linea con il disegno originale.

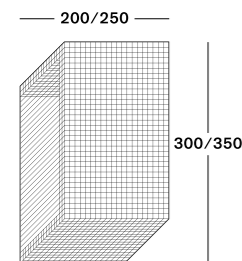

2750 Quaderna, Writing desk
Superstudio
1969-1972

Writing desk

Honeycomb core structure coated with white Print laminate, digitally printed with black squares at 3 cm spacing. The top hides a retractable pull-out drawer, with a drawer compartment in black scratch-resistant embossed painted wood.

Scrivania

Struttura in legno tamburato placcato laminato Print, colore bianco, a stampa digitale a quadretti con interasse di 3 cm. Cassetto estraibile a scomparsa ricavato nello spessore del piano, vano cassetto in legno verniciato goffrato antigraffio colore nero.

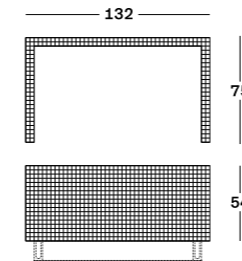

Zanotta Spa

20834 Nova Milanese
(MB), Italy
Via Vittorio Veneto 57
T: +39 0362 49 81

General information
zanottaspa@zanotta.it
www.zanotta.it

Zanotta House Milano

20154 Milano (MI), Italy
Piazza XXV Aprile 16
T: +39 0362 49 84 00

Zanotta House New York

New York, 10014 US
23, Cornelia street

Re-Connecting.
2022 new products
©2022 Zanotta Spa,
all rights reserved

Graphic design:
Think Work Observe

Photography:
Simone Barberis

Copywriting:
Mavi Cerenza

Pre-press:
Alt® Aluce Srl

Print:
Grafiche Antiga, 2022

Zanotta Spa reserves the right to change, without previous notice, materials, covers, finishes and drawings of the products presented in this catalogue. The textures and colours of materials and finishes are indicative as they are depending on the tolerance of the printing process.

Zanotta Spa si riserva di apportare, senza preavviso, modifiche nei materiali, nei rivestimenti, nelle finiture e nei disegni dei prodotti presentati in questo catalogo. Le texture ed i colori dei materiali e delle finiture hanno valore indicativo in quanto soggetti alle tolleranze dei processi di stampa.

We design having people in mind, not design.

